

Qty.	Description
1	<p data-bbox="199 331 526 365">CUE 3X380-500V IP55 11KW</p> <div data-bbox="319 414 459 672" style="text-align: center;">  </div> <p data-bbox="590 683 1061 705" style="text-align: center;">Note! Product picture may differ from actual product</p> <p data-bbox="199 716 478 739">Product No.: On request</p> <p data-bbox="199 772 1420 851">CUE is a complete range of external frequency converters designed for speed control of a wide range of Grundfos pumps. CUE has a built-in PI controller and offers the same functionality and user-interface as Grundfos E-pumps. CUE solutions can thus be seen as an extension to the E-pump range.</p> <p data-bbox="199 862 877 884">By choosing a CUE-solution, you will get the following benefits:</p> <ul data-bbox="239 896 1189 1064" style="list-style-type: none"> - Grundfos E-pump functionality and user-interface - application- and pump-family-related functions - increased comfort compared to fixed-speed pumps - very easy installation and commissioning compared to standard frequency converters - speed control of pumps up to 250 kW - speed control of pumps installed in potentially explosive environments. <p data-bbox="199 1070 662 1093">CUE offers the following inputs and output:</p> <ul data-bbox="239 1097 1021 1243" style="list-style-type: none"> - RS-485 GENIbus - an analog 0-10 V input for external setpoint - an analog 0/4-20 mA input for sensor - four digital inputs for various functions, for instance external start/stop - two signal relays (C/NO/NC). <p data-bbox="199 1276 343 1299">Accessories:</p> <p data-bbox="199 1310 478 1332">Input/output add-on board</p> <p data-bbox="199 1344 470 1366">Provides additional input:</p> <ul data-bbox="239 1370 1189 1451" style="list-style-type: none"> - one 0/4-20 mA analog input for an additional sensor - one 0-20 mA analog output - two inputs for Pt100/Pt1000 temperature sensors, for instance for bearing monitoring. <p data-bbox="199 1489 335 1512">Motor filters:</p> <p data-bbox="199 1518 1428 1568">For reduction of dU/dt and peak voltages to the motor windings and for reduction of the acoustic noise generated in the motor, a number of motor filters are offered:</p> <ul data-bbox="239 1572 614 1630" style="list-style-type: none"> - dU/dt filters , 11-250 kW - Sine wave filters, 0.55-250 kW. <p data-bbox="199 1662 311 1684">Technical:</p> <p data-bbox="199 1691 790 1713">Approvals on nameplate: CE, CULUS, C-TICK</p> <p data-bbox="199 1751 327 1774">Installation:</p> <p data-bbox="199 1780 670 1803">Range of ambient temperature: 0 .. 45 °C</p> <p data-bbox="199 1809 646 1832">Relative humidity: 5-95 %</p> <p data-bbox="199 1870 359 1892">Electrical data:</p> <p data-bbox="199 1899 638 1921">Rated power - P2: 11 kW</p> <p data-bbox="199 1928 678 1951">Mains frequency: 50 / 60 Hz</p> <p data-bbox="199 1957 813 1980">Rated voltage [V]: 3 x 380-440/441-500 V</p> <p data-bbox="199 1986 654 2009">Rated current: 24-21 A</p> <p data-bbox="199 2016 614 2038">Maximum current consumption: 24 A</p> <p data-bbox="199 2045 622 2067">Efficiency at full load: 98 %</p> <p data-bbox="199 2074 614 2096">Enclosure class (IEC 34-5): IP55</p>



Company name:

Created by:

Phone:

Date:

16/06/2022

Qty.	Description
------	-------------

	Others: Net weight: 23 kg Danish VVS No.: 382996110 Country of origin: DK Custom tariff no.: 85044090
--	---

Description	Value
General information:	
Product name:	CUE 3X380-500V IP55 11KW
Product No:	On request
EAN number:	On request
Technical:	
Approvals on nameplate:	CE, CULUS, C-TICK
Installation:	
Range of ambient temperature:	0 .. 45 °C
Relative humidity:	5-95 %
Mounted on:	Wall
Electrical data:	
Rated power - P2:	11 kW
Mains frequency:	50 / 60 Hz
Rated voltage [V]:	3 x 380-440/441-500 V
Rated current:	24-21 A
Maximum current consumption:	24 A
Efficiency at full load:	98 %
Enclosure class (IEC 34-5):	IP55
Built-in motor protection:	YES
Thermal protec:	external
Cable length:	150/300 m
Others:	
Net weight:	23 kg
Danish VVS No.:	382996110
Country of origin:	DK
Custom tariff no.:	85044090

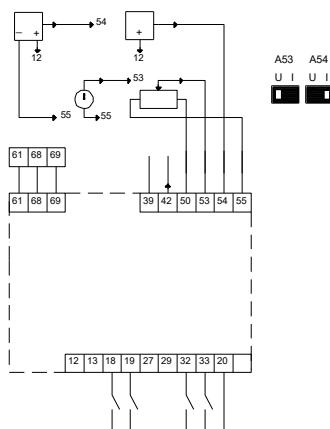
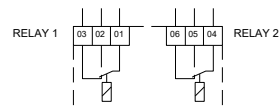
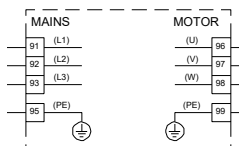
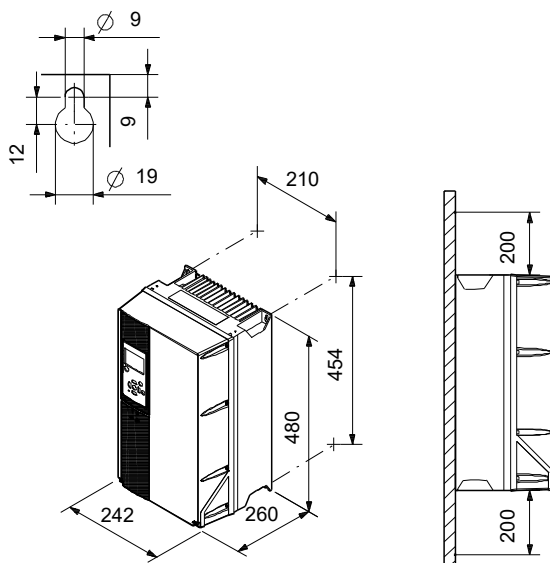

On request CUE 3X380-500V IP55 11KW

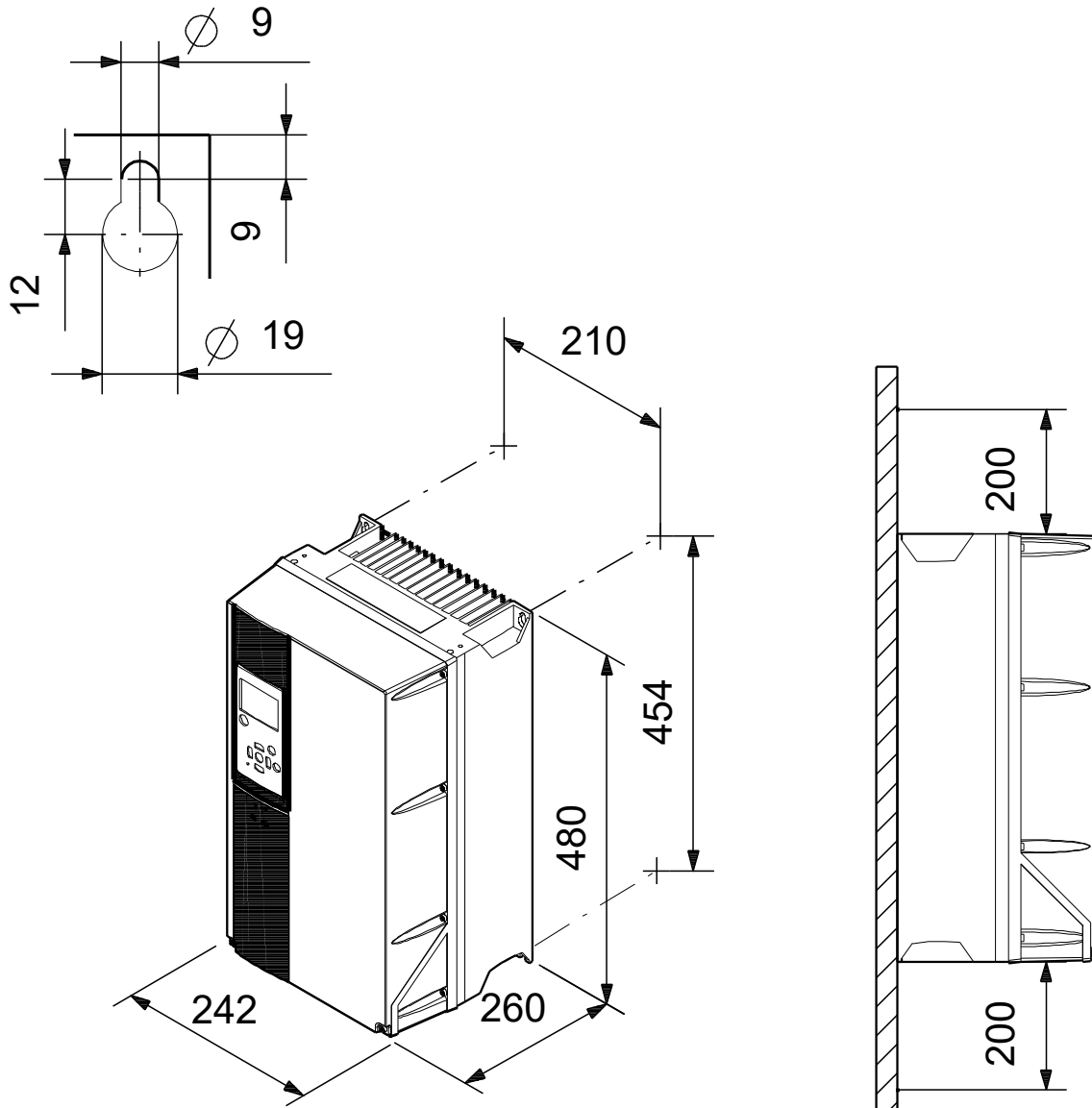

Note! All units are in [mm] unless others are stated.
Disclaimer: This simplified dimensional drawing does not show all details.



Company name:

Created by:

Phone:

Date:

16/06/2022

Order Data:

Product name: CUE 3X380-500V IP55 11KW

Amount: 1

Product No: On request

Total: Price on request
