

Qty.	Description
1	<p data-bbox="199 324 582 369">CUE 3X380-500V IP20 15KW STO</p> <div data-bbox="311 414 470 672" style="text-align: center;">  </div> <p data-bbox="590 683 1061 705" style="text-align: center;">Note! Product picture may differ from actual product</p> <p data-bbox="199 712 478 739">Product No.: On request</p> <p data-bbox="199 772 1420 851">CUE is a complete range of external frequency converters designed for speed control of a wide range of Grundfos pumps. CUE has a built-in PI controller and offers the same functionality and user-interface as Grundfos E-pumps. CUE solutions can thus be seen as an extension to the E-pump range.</p> <p data-bbox="199 857 877 884">By choosing a CUE-solution, you will get the following benefits:</p> <ul data-bbox="231 887 1189 1064" style="list-style-type: none"> - Grundfos E-pump functionality and user-interface - application- and pump-family-related functions - increased comfort compared to fixed-speed pumps - very easy installation and commissioning compared to standard frequency converters - speed control of pumps up to 250 kW - speed control of pumps installed in potentially explosive environments. <p data-bbox="199 1066 662 1093">CUE offers the following inputs and output:</p> <ul data-bbox="231 1095 1021 1243" style="list-style-type: none"> - RS-485 GENIbus - an analog 0-10 V input for external setpoint - an analog 0/4-20 mA input for sensor - four digital inputs for various functions, for instance external start/stop - two signal relays (C/NO/NC). <p data-bbox="199 1272 343 1299">Accessories:</p> <p data-bbox="199 1301 486 1328">Input/output add-on board</p> <p data-bbox="199 1330 470 1357">Provides additional input:</p> <ul data-bbox="231 1359 1189 1451" style="list-style-type: none"> - one 0/4-20 mA analog input for an additional sensor - one 0-20 mA analog output - two inputs for Pt100/Pt1000 temperature sensors, for instance for bearing monitoring. <p data-bbox="199 1480 343 1507">Motor filters:</p> <p data-bbox="199 1509 1428 1563">For reduction of dU/dt and peak voltages to the motor windings and for reduction of the acoustic noise generated in the motor, a number of motor filters are offered:</p> <ul data-bbox="231 1568 614 1630" style="list-style-type: none"> - dU/dt filters , 11-250 kW - Sine wave filters, 0.55-250 kW. <p data-bbox="199 1659 311 1686">Technical:</p> <p data-bbox="199 1688 790 1715">Approvals on nameplate: CE, CULUS, C-TICK</p> <p data-bbox="199 1747 327 1774">Installation:</p> <p data-bbox="199 1776 670 1803">Range of ambient temperature: 0 .. 45 °C</p> <p data-bbox="199 1805 646 1832">Relative humidity: 5-95 %</p> <p data-bbox="199 1863 359 1890">Electrical data:</p> <p data-bbox="199 1892 638 1919">Rated power - P2: 15 kW</p> <p data-bbox="199 1921 678 1948">Mains frequency: 50 / 60 Hz</p> <p data-bbox="199 1951 813 1977">Rated voltage [V]: 3 x 380-440/441-500 V</p> <p data-bbox="199 1980 654 2007">Rated current: 32-27 A</p> <p data-bbox="199 2009 614 2036">Maximum current consumption: 32 A</p> <p data-bbox="199 2038 622 2065">Efficiency at full load: 98 %</p> <p data-bbox="199 2067 614 2094">Enclosure class (IEC 34-5): IP20</p>



Company name:

Created by:

Phone:

Date:

17/06/2022

Qty.	Description
	<p data-bbox="199 333 287 367">Others:</p> <p data-bbox="199 365 630 400">Net weight: 12 kg</p>

Description	Value
General information:	
Product name:	CUE 3X380-500V IP20 15KW STO
Product No:	On request
EAN number:	On request
Technical:	
Approvals on nameplate:	CE, CULUS, C-TICK
Installation:	
Range of ambient temperature:	0 .. 45 °C
Relative humidity:	5-95 %
Mounted on:	Wall
Electrical data:	
Rated power - P2:	15 kW
Mains frequency:	50 / 60 Hz
Rated voltage [V]:	3 x 380-440/441-500 V
Rated current:	32-27 A
Maximum current consumption:	32 A
Efficiency at full load:	98 %
Enclosure class (IEC 34-5):	IP20
Built-in motor protection:	YES
Thermal protec:	external
Cable length:	150/300 m
Others:	
Net weight:	12 kg

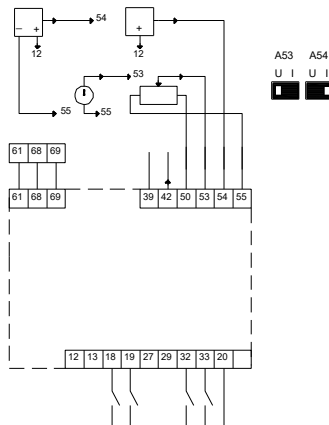
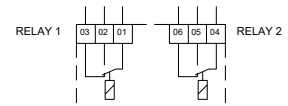
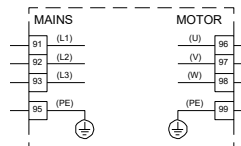
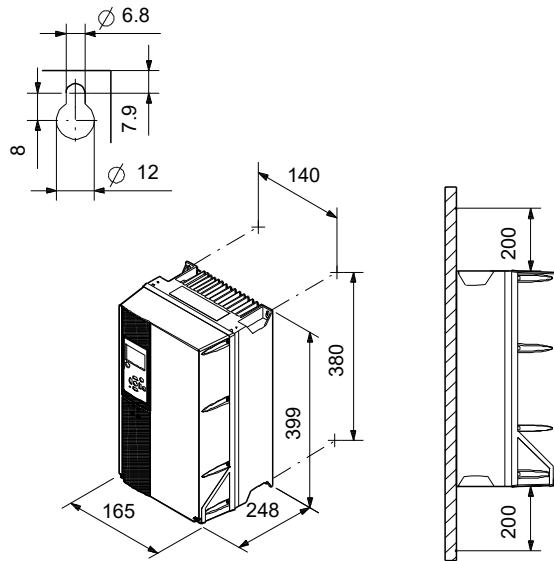

On request CUE 3X380-500V IP20 15KW STO

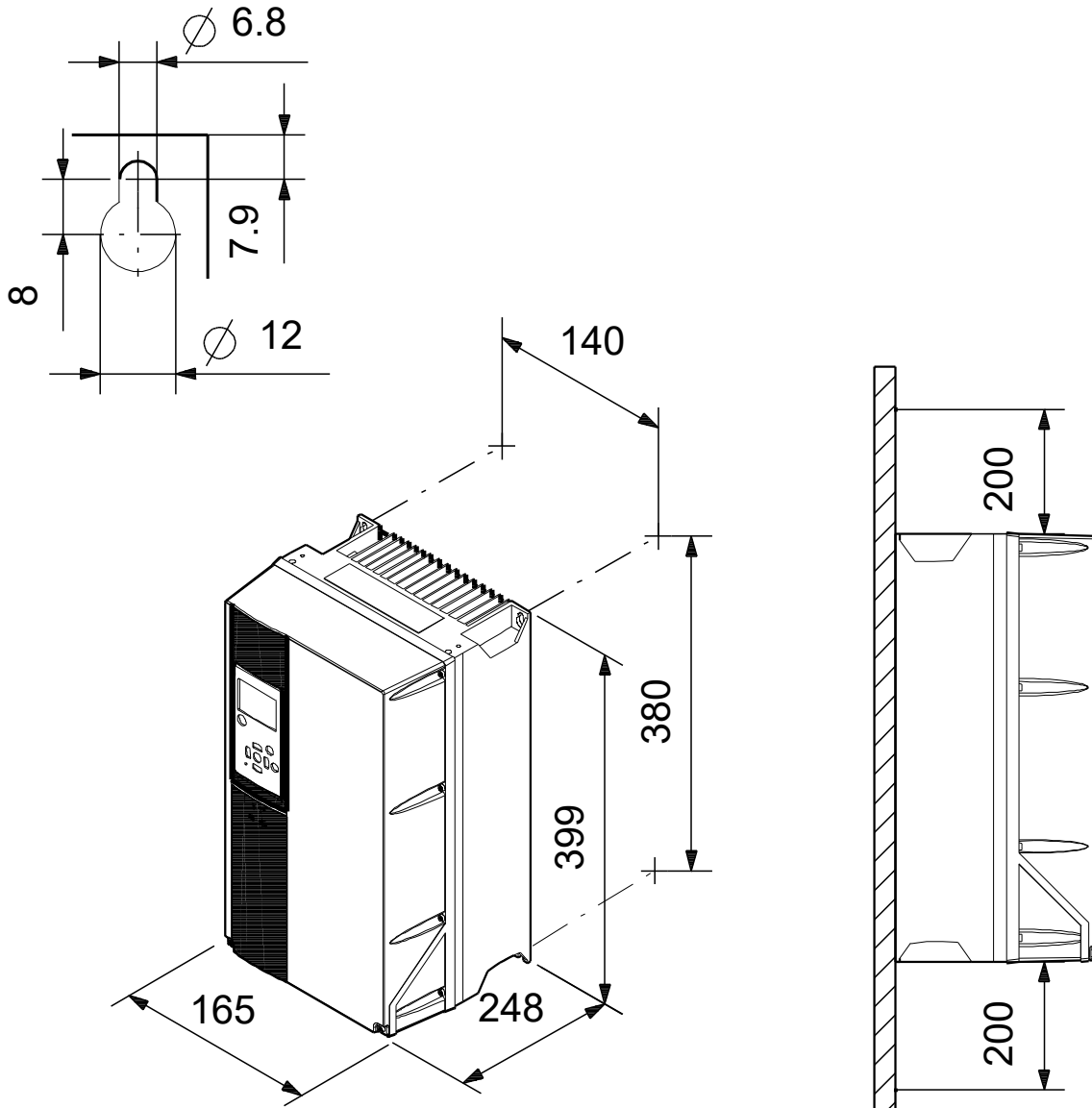

Note! All units are in [mm] unless others are stated.
Disclaimer: This simplified dimensional drawing does not show all details.



Company name:

Created by:

Phone:

Date:

17/06/2022

Order Data:

Product name: CUE 3X380-500V IP20 15KW STO

Amount: 1

Product No: On request

Total: Price on request
