

Qty.	Description
1	<p data-bbox="204 338 539 360">CUE 3X380-500V IP21 110KW</p> <div data-bbox="331 405 456 674" style="text-align: center;">  </div> <p data-bbox="595 685 1062 707" style="text-align: center;">Note! Product picture may differ from actual product</p> <p data-bbox="204 719 480 741">Product No.: On request</p> <p data-bbox="204 775 1422 846">CUE is a complete range of external frequency converters designed for speed control of a wide range of Grundfos pumps. CUE has a built-in PI controller and offers the same functionality and user-interface as Grundfos E-pumps. CUE solutions can thus be seen as an extension to the E-pump range.</p> <p data-bbox="204 857 874 880">By choosing a CUE-solution, you will get the following benefits:</p> <ul data-bbox="240 891 1190 1066" style="list-style-type: none"> - Grundfos E-pump functionality and user-interface - application- and pump-family-related functions - increased comfort compared to fixed-speed pumps - very easy installation and commissioning compared to standard frequency converters - speed control of pumps up to 250 kW - speed control of pumps installed in potentially explosive environments. <p data-bbox="204 1070 660 1093">CUE offers the following inputs and output:</p> <ul data-bbox="240 1104 1023 1245" style="list-style-type: none"> - RS-485 GENIbus - an analog 0-10 V input for external setpoint - an analog 0/4-20 mA input for sensor - four digital inputs for various functions, for instance external start/stop - two signal relays (C/NO/NC). <p data-bbox="204 1279 336 1301">Accessories:</p> <p data-bbox="204 1312 480 1335">Input/output add-on board</p> <p data-bbox="204 1346 472 1368">Provides additional input:</p> <ul data-bbox="240 1379 1190 1451" style="list-style-type: none"> - one 0/4-20 mA analog input for an additional sensor - one 0-20 mA analog output - two inputs for Pt100/Pt1000 temperature sensors, for instance for bearing monitoring. <p data-bbox="204 1485 336 1507">Motor filters:</p> <p data-bbox="204 1518 1430 1563">For reduction of dU/dt and peak voltages to the motor windings and for reduction of the acoustic noise generated in the motor, a number of motor filters are offered:</p> <ul data-bbox="240 1574 616 1630" style="list-style-type: none"> - dU/dt filters , 11-250 kW - Sine wave filters, 0.55-250 kW. <p data-bbox="204 1664 312 1686">Technical:</p> <p data-bbox="204 1697 791 1720">Approvals on nameplate: CE, CULUS, C-TICK</p> <p data-bbox="204 1753 320 1776">Installation:</p> <p data-bbox="204 1787 667 1809">Range of ambient temperature: 0 .. 40 °C</p> <p data-bbox="204 1821 639 1843">Relative humidity: 5-95 %</p> <p data-bbox="204 1877 360 1899">Electrical data:</p> <p data-bbox="204 1910 647 1933">Rated power - P2: 110 kW</p> <p data-bbox="204 1944 679 1966">Mains frequency: 50 / 60 Hz</p> <p data-bbox="204 1977 807 2000">Rated voltage [V]: 3 x 380-440/441-500 V</p> <p data-bbox="204 2011 679 2033">Rated current: 212-190 A</p> <p data-bbox="204 2045 632 2067">Maximum current consumption: 212 A</p> <p data-bbox="204 2078 624 2101">Efficiency at full load: 98 %</p> <p data-bbox="204 2112 616 2134">Enclosure class (IEC 34-5): IP21</p>



Company name:

Created by:

Phone:

Date:

17/06/2022

Qty.	Description
	<p data-bbox="199 331 287 369">Others:</p> <p data-bbox="199 369 630 403">Net weight: 62 kg</p>

Description	Value
General information:	
Product name:	CUE 3X380-500V IP21 110KW
Product No:	On request
EAN number:	On request
Technical:	
Approvals on nameplate:	CE, CULUS, C-TICK
Installation:	
Range of ambient temperature:	0 .. 40 °C
Relative humidity:	5-95 %
Mounted on:	WALL / FLOOR
Electrical data:	
Rated power - P2:	110 kW
Mains frequency:	50 / 60 Hz
Rated voltage [V]:	3 x 380-440/441-500 V
Rated current:	212-190 A
Maximum current consumption:	212 A
Efficiency at full load:	98 %
Enclosure class (IEC 34-5):	IP21
Built-in motor protection:	YES
Thermal protec:	external
Cable length:	150/300 m
Others:	
Net weight:	62 kg

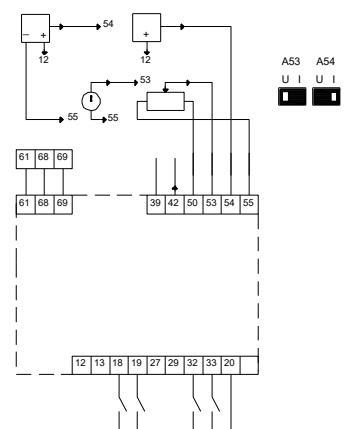
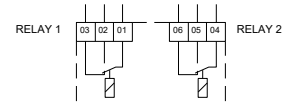
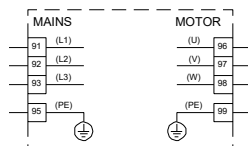
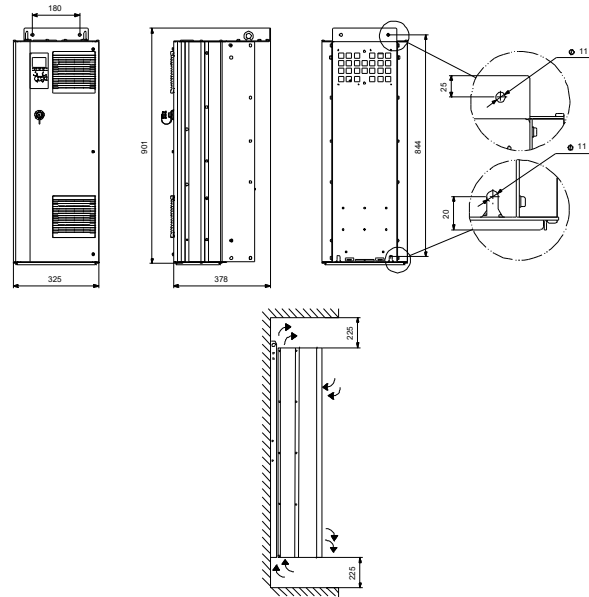

On request CUE 3X380-500V IP21 110KW

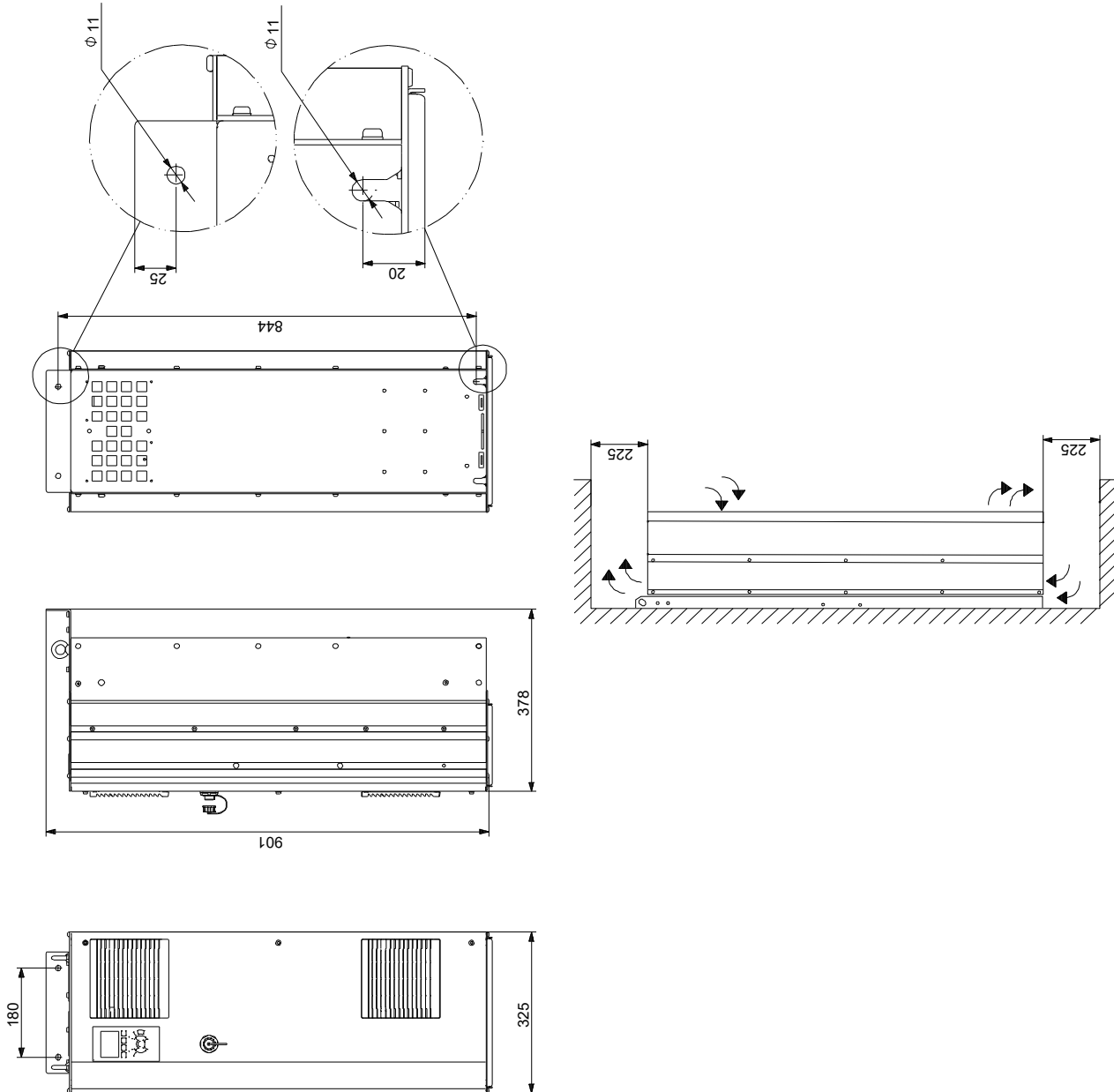

Note! All units are in [mm] unless others are stated.
Disclaimer: This simplified dimensional drawing does not show all details.



Company name:

Created by:

Phone:

Date:

17/06/2022

Order Data:

Product name: CUE 3X380-500V IP21 110KW

Amount: 1

Product No: On request

Total: Price on request
