

Qty. Description

1 TPE3 D 100-180 S-A-F-A-BQQE-IDB



Note! Product picture may differ from actual product

Product No.: On request

Single-stage, close-coupled, volute twin-head pump with in-line suction and discharge ports of identical diameter. The twin-head pump is designed with two parallel power-heads.

The pump is of the top-pull-out design, i.e. the power head (motor, pump head and impeller) can be removed for maintenance or service while the pump housing remains in the pipework.

Each power head is fitted with an unbalanced rubber bellows seal.

The shaft seal is according to EN 12756. Pipework connection is via PN 10 DIN flanges (EN 1092-2 and ISO 7005-2).

Each power head is fitted with a fan-cooled, permanent-magnet synchronous motor of identical size. The motor efficiency is classified as IE5 in accordance with IEC 60034-30-2.

The motor includes a frequency converter and PI controller in the motor terminal box. This enables continuously variable control of the motor speed, which again enables adaptation of the performance to a given requirement.

The pump is fitted with a combined temperature- and differential pressure sensor.

The pump is suitable for applications requiring pressure or temperature control and offers following control modes:

- AUTOADAPT. This function continuously adjusts the proportional-pressure curve and automatically sets a more efficient curve without compromising comfort demands.
- FLOWADAPT. This control mode combines AUTOADAPT with a flow-limiting function. The pump continuously monitors the flow rate to ensure the desired maximum flow is not exceeded. This will save the cost of a separate pump-throttling valve.
- Constant differential pressure. The pump head is kept constant, independent of the flow in the system.
- Proportional pressure. The head of the pump will increase proportionally to the flow in the system to compensate for the large pressure losses in the distribution pipes.
- Constant temperature. The return-pipe temperature is kept constant. Note: If the pump is installed in the flow pipe, an external temperature sensor must be installed in the return pipe of the system.
- Constant differential temperature. The differential temperature can be measured by a differential-temperature sensor or two separate temperature sensors.
- Constant curve. The pump can be set to run at a constant speed in the range of 25 to 100 % of the maximum speed.

Wireless communication between the two power heads is quickly and easily obtained. The pump heads can be set to cascade mode, alternating mode or duty/standby.

The product's minimum efficiency index (MEI) is greater or equal to 0.70. This is by the Commission Regulation (EU) considered as an indicative benchmark for best-performing water pump available on the market as from 1 January 2013.

The operating panel on the motor terminal box features a four-inch TFT display, push-buttons and the Grundfos Eye indicator.

The display gives an intuitive and user-friendly interface to all functions.

The push-buttons are used to navigate through the menu structure to access pump and performance data on site and enable setting of required setpoint as well as setting of pump to "Min." or "Max." operation or to "Stop".

The Grundfos Eye indicator on the operating panel provides visual indication of pump status:

- "Power on": Motor is running (rotating green indicator lights) or not running (permanently green indicator lights)
- "Warning": Motor is still running (rotating yellow indicator lights) or has stopped (permanently yellow indicator lights)
- "Alarm": Motor has stopped (flashing red indicator lights).

Qty. Description

Communication with the pump is also possible by means of Grundfos GO Remote (accessory). The remote control enables further settings as well as reading out of a number of parameters such as "Actual value", "Speed", "Power input" and total "Power consumption".

Cast-iron parts have an epoxy-based coating made in a cathodic electro-deposition (CED) process. CED is a high-quality dip-painting process where an electrical field around the products ensures deposition of paint particles as a thin, well-controlled layer on the surface.

Pump

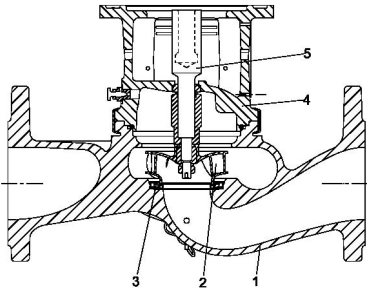

- 1: Pump housing
- 2: Impeller
- 3: Neck ring
- 4: Pump head/motor stool
- 5: Stub shaft

The twin-head pump is designed with two parallel power-heads. A flap valve in the common discharge port is opened by the flow of the pumped liquid and prevents backflow of liquid into the idle pump head.

The pump housing is provided with a replaceable stainless steel/PTFE neck ring to reduce the amount of liquid running from the discharge side of the impeller to the suction side.

The impeller is secured to the shaft with a nut.

The pump is fitted with an unbalanced rubber bellows seal with torque transmission across the spring and around the bellows. Due to the bellows, the seal does not wear the shaft, and the axial movement is not prevented by deposits on the shaft.

Seal faces:

- Rotating seal ring material: silicon carbide (SiC)
- Stationary seat material: silicon carbide (SiC)

This material pairing is used where higher corrosion resistance is required. The high hardness of this material pairing offers good resistance against abrasive particles.

Secondary seal material: EPDM (ethylene-propylene rubber)

EPDM has excellent resistance to hot water. EPDM is not suitable for mineral oils.

Twin-head pumps installed in horizontal pipes must be fitted with an automatic air vent in the upper part of the pump housing. The automatic air vent is not supplied with the pump.

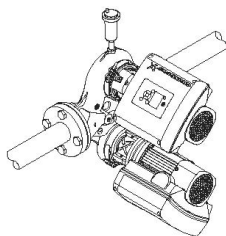

The motor stool forms connection between the pump housing and the motor, and is equipped with a manual air vent screw for venting of the pump housing and the shaft seal chamber. The sealing between motor stool and pump housing is an O-ring.

The central part of the motor stool is provided with guards for protection against the shaft and coupling. The pump shaft is fastened directly on the motor shaft with key and set screws.

Motor

The motor is a totally enclosed, fan-cooled motor with principal dimensions to IEC and DIN standards. Electrical tolerances comply with IEC 60034.

The motor efficiency is classified as IE5 in accordance with IEC 60034-30-2.

Qty.	Description
	<p>The motor requires no external motor protection. The motor control unit incorporates protection against slow- and quick-rising temperatures, e.g. constant overload and stalled conditions.</p> <p>The terminal box holds terminals for these connections:</p> <ul style="list-style-type: none"> - one dedicated digital input - two analog inputs, 0(4)-20 mA, 0-10 V - one configurable digital input or open-collector output - Grundfos combined temperature and differential pressure sensor (separate connected) - 24 V voltage supply for sensors - two signal relay outputs (potential-free contacts) - the two power heads communicate via wireless GENIair or wired GENI connection - interface for Grundfos CIM fieldbus module. <p>The terminal box holds terminals for these connections:</p> <ul style="list-style-type: none"> - one dedicated digital input - two analog inputs, 0(4)-20 mA, 0-10 V - one configurable digital input or open-collector output - Grundfos combined temperature and differential pressure sensor (separate connected) - 24 V voltage supply for sensors - two signal relay outputs (potential-free contacts) - GENIbus connection - interface for Grundfos CIM fieldbus module. <p>Further product details</p> <p>Cast-iron parts have an epoxy-based coating made in a cathodic electro-deposition (CED) process. CED is a high-quality dip-painting process where an electrical field around the products ensures deposition of paint particles as a thin, well-controlled layer on the surface.</p> <p>Technical data</p> <p>Controls:</p> <p>Frequency converter: Built-in</p> <p>Liquid:</p> <p>Pumped liquid: Water</p> <p>Liquid temperature range: -25 .. 120 °C</p> <p>Selected liquid temperature: 20 °C</p> <p>Density: 998.2 kg/m³</p> <p>Technical:</p> <p>Pump speed on which pump data are based: 3890 rpm</p> <p>Rated flow: 50.2 m³/h</p> <p>Rated head: 12.7 m</p> <p>Actual impeller diameter: 90 mm</p> <p>Code for shaft seal: BQQE</p> <p>Curve tolerance: ISO9906:2012 3B2</p> <p>Materials:</p> <p>Pump housing: Cast iron EN-GJL-250 ASTM class 35</p> <p>Impeller: Composite PES+30% GF</p> <p>Installation:</p> <p>Range of ambient temperature: -20 .. 50 °C</p> <p>Maximum operating pressure: 10 bar</p> <p>Max pressure at stated temp: 10 bar / 120 °C</p> <p>Type of connection: DIN</p> <p>Size of connection: DN 100</p>

Qty.	Description
	<p>Pressure rating for connection: PN 10 Port-to-port length: 450 mm Flange size for motor: 56C</p> <p>Electrical data: Motor type: 90LD IE Efficiency class: IE5 Rated power - P2: 2.2 kW Mains frequency: 50 Hz Rated voltage: 3 x 380-500 V Rated current: 4.15-3.40 A Cos phi - power factor: 0.93-0.87 Rated speed: 360-4000 rpm Efficiency: 90.1% Motor efficiency at full load: 90.1 % Enclosure class (IEC 34-5): IP55 Insulation class (IEC 85): F Motor No: 99138048</p> <p>Others: Minimum efficiency index, MEI \geq: 0.70 Net weight: 78.3 kg Gross weight: 93.9 kg Shipping volume: 0.315 m³ Country of origin: HU Custom tariff no.: 84137065</p>

Description	Value
General information:	
Product name:	TPE3 D 100-180 S-A-F-A-BQQE-IDB
Product No:	On request
EAN number:	On request
Technical:	
Pump speed on which pump data are based:	3890 rpm
Rated flow:	50.2 m ³ /h
Rated head:	12.7 m
Maximum head:	180 dm
Actual impeller diameter:	90 mm
Code for shaft seal:	BQQE
Curve tolerance:	ISO9906:2012 3B2
Pump version:	A
Materials:	
Pump housing:	Cast iron
Pump housing:	EN-GJL-250
Pump housing:	ASTM class 35
Impeller:	Composite
Impeller:	PES+30% GF
Material code:	A
Installation:	
Range of ambient temperature:	-20 .. 50 °C
Maximum operating pressure:	10 bar
Max pressure at stated temp:	10 bar / 120 °C
Type of connection:	DIN
Size of connection:	DN 100
Pressure rating for connection:	PN 10
Port-to-port length:	450 mm
Flange size for motor:	56C
Connect code:	F
Liquid:	
Pumped liquid:	Water
Liquid temperature range:	-25 .. 120 °C
Selected liquid temperature:	20 °C
Density:	998.2 kg/m ³
Electrical data:	
Motor type:	90LD
IE Efficiency class:	IE5
Rated power - P2:	2.2 kW
Mains frequency:	50 Hz
Rated voltage:	3 x 380-500 V
Rated current:	4.15-3.40 A
Cos phi - power factor:	0.93-0.87
Rated speed:	360-4000 rpm
Efficiency:	90.1%
Motor efficiency at full load:	90.1 %
Enclosure class (IEC 34-5):	IP55
Insulation class (IEC 85):	F
Built-in motor protection:	ELEC
Motor No:	99138048
Controls:	
Control panel:	HMI300 - Graphical
Function Module:	FM300 - Advanced
Frequency converter:	Built-in
Others:	
Minimum efficiency index, MEI ≥:	0.70
Net weight:	78.3 kg

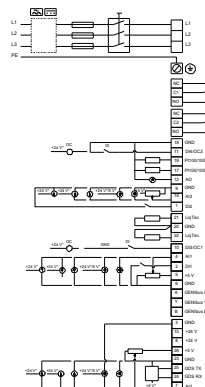
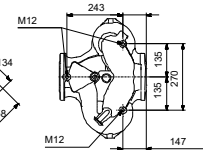
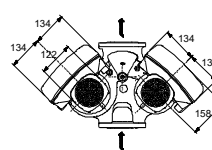
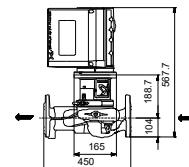
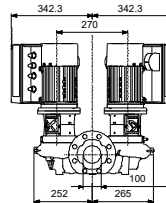
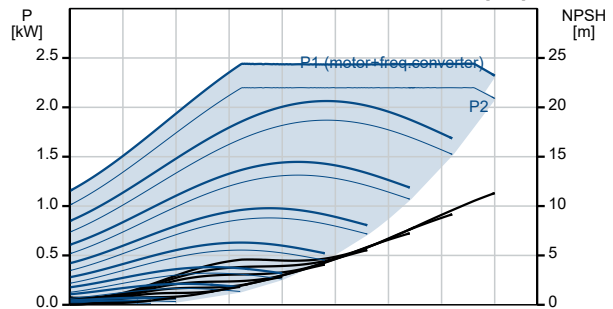
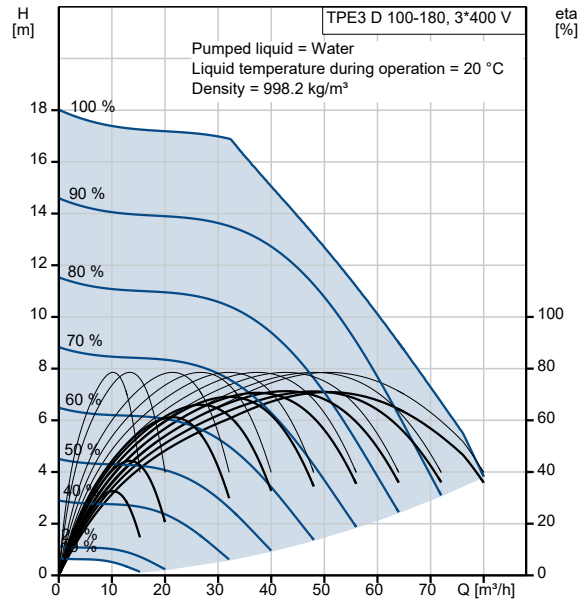



Company name:

Created by:

Phone:

Date:

16/06/2022

Description	Value
Gross weight:	93.9 kg
Shipping volume:	0.315 m ³
Config. file no:	98484693
Country of origin:	HU
Custom tariff no.:	84137065

On request TPE3 D 100-180 S-A-F-A-BQQE-IDB 50 Hz

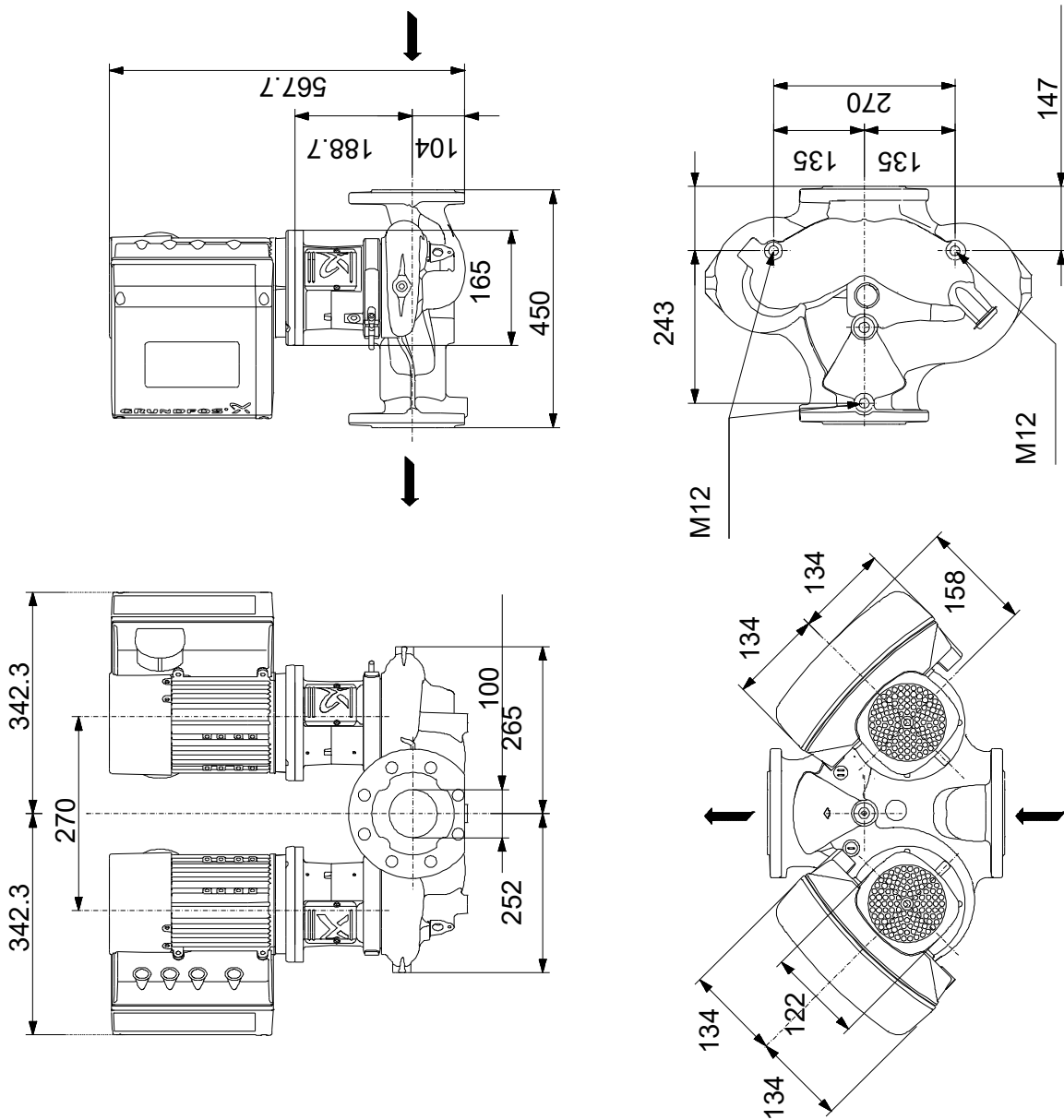

Note! All units are in [mm] unless others are stated.
Disclaimer: This simplified dimensional drawing does not show all details.



Company name:

Created by:

Phone:

Date:

16/06/2022

Order Data:

Product name: TPE3 D 100-180

Amount: 1

Product No: On request

Total: Price on request
