

Qty.	Description
1	<p data-bbox="201 159 536 188"><b>HYDRO MULTI-E 2 CRIE 20-4</b></p> <div data-bbox="260 266 518 465" style="text-align: center;">  </div> <p data-bbox="592 506 1062 530" style="text-align: center;"><b>Note! Product picture may differ from actual product</b></p> <p data-bbox="201 537 464 564">Product No.: <a href="#">99133601</a></p> <p data-bbox="201 598 1372 649">GRUNDFOS Hydro Multi-E booster sets are designed for the transfer and pressure boosting of clean water in waterworks, blocks of flats, hotels, industry, hospitals, schools, etc.</p> <p data-bbox="201 656 1453 707">GRUNDFOS Hydro Multi-E booster set consists of 2 to 4 CRIE pumps coupled in parallel and mounted on a common base frame provided with all the necessary fittings.</p> <p data-bbox="201 741 1235 770">Hydro Multi-E is mounted on a common base frame made of stainless steel (DIN W.-Nr. 1.4301).</p> <p data-bbox="201 775 845 804">On the suction side are fitted a suction manifold (DIN W.-Nr.</p> <p data-bbox="201 808 432 837">1.4401 or DIN W.-Nr.</p> <p data-bbox="201 842 1062 871">1.4571) , a pressure switch mounted on a drainable valve and an isolating valve.</p> <p data-bbox="201 875 1437 927">On the discharge side of the pumps are fitted a non-return valve, an isolating valve, a pressure gauge, two pressure transmitters mounted on a drainable valve a diaphragm tank and a stainless steel discharge manifold (DIN W.-Nr.</p> <p data-bbox="201 954 432 983">1.4401 or DIN W.-Nr.</p> <p data-bbox="201 987 293 1016">1.4571).</p> <p data-bbox="201 1021 948 1050">The Hydro Multi-E is fitted with an on/off-switch for the supply voltage.</p> <p data-bbox="201 1077 1374 1106">The Hydro Multi-E is designed for maintaining a constant pressure regardless of flow changes and fluctuation.</p> <p data-bbox="201 1133 1382 1184">The internal PI-controller regulates the number of running pumps and the speed of the pumps according to the required flow.</p> <p data-bbox="201 1211 1433 1240">The system can be operated directly on the panel of any of the pumps or via Grundfos GO (available as accessory)</p> <p data-bbox="201 1301 512 1330">Besides the system features:</p> <ul data-bbox="201 1335 847 1570" style="list-style-type: none"> <li>2 Digital outputs</li> <li>2 Digital inputs (one used for dry run protection)</li> <li>2 Analogue inputs (one used for discharge pressure sensor)</li> <li>Multi-Master functionality</li> <li>2 Limit functions</li> <li>Set-point influence function</li> <li>Pipe filling function</li> <li>High efficient PM motors</li> </ul> <p data-bbox="201 1603 584 1632">Available communication protocols:</p> <ul data-bbox="201 1637 400 1895" style="list-style-type: none"> <li>•LON</li> <li>•Profibus</li> <li>•Modbus</li> <li>•SMS/GSM/GPRS</li> <li>•GRM</li> <li>•BACnet</li> <li>•BACnet IP</li> <li>•Modbus TCP</li> <li>•PROFINET</li> </ul> <p data-bbox="201 1928 1278 1957">When delivered, the GRUNDFOS Hydro Multi-E booster set is factory tested and ready for operation.</p> <p data-bbox="201 2018 632 2078">Liquid: Pumped liquid:                      Water</p>

Qty.	Description
1	<p>Liquid temperature range: 5 .. 60 °C  Selected liquid temperature: 20 °C  Density: 998.2 kg/m<sup>3</sup></p> <p>Technical:  Max flow: 72 m<sup>3</sup>/h</p> <p>Materials:  Pump housing: Stainless steel</p> <p>Installation:  Maximum operating pressure: 16 bar  Maximum permissible inlet pressure: PN 16 bar  Flange standard: DIN2642  Manifold inlet: DN 80  Manifold outlet: DN 80</p> <p>Electrical data:  IE Efficiency class: IE5  Power (P2) main pump: 7.5 kW  Mains frequency: 50 / 60 Hz  Rated voltage: 3 x 380-415 V  Rated current: 27 A  Start. method: electronically  Enclosure class (IEC 34-5): IP54</p> <p>Tank:  Volume of pressure tank: 25 l  Diaphragm tank: Yes</p> <p>Others:  Net weight: 261 kg  Gross weight: 320 kg  Shipping volume: 1.05 m<sup>3</sup>  Language: GB  Country of origin: GB  Custom tariff no.: 84137075</p>

# 99133601 HYDRO MULTI-E 2 CRIE 20-4

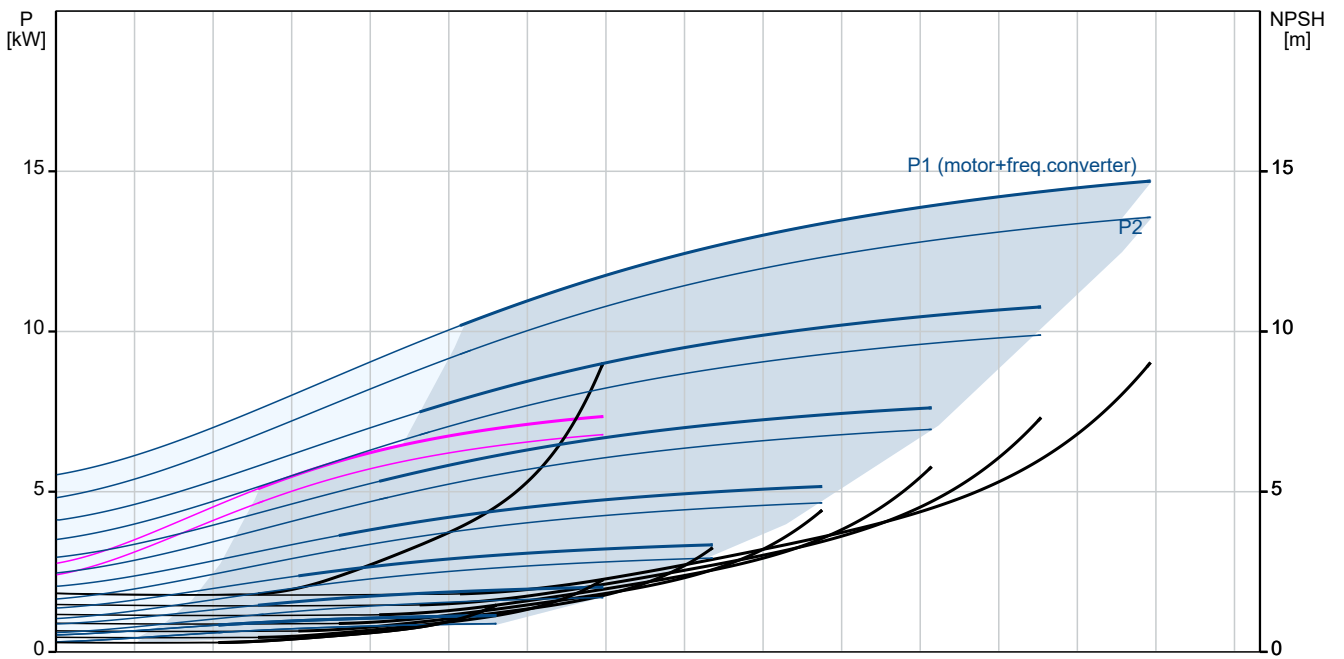
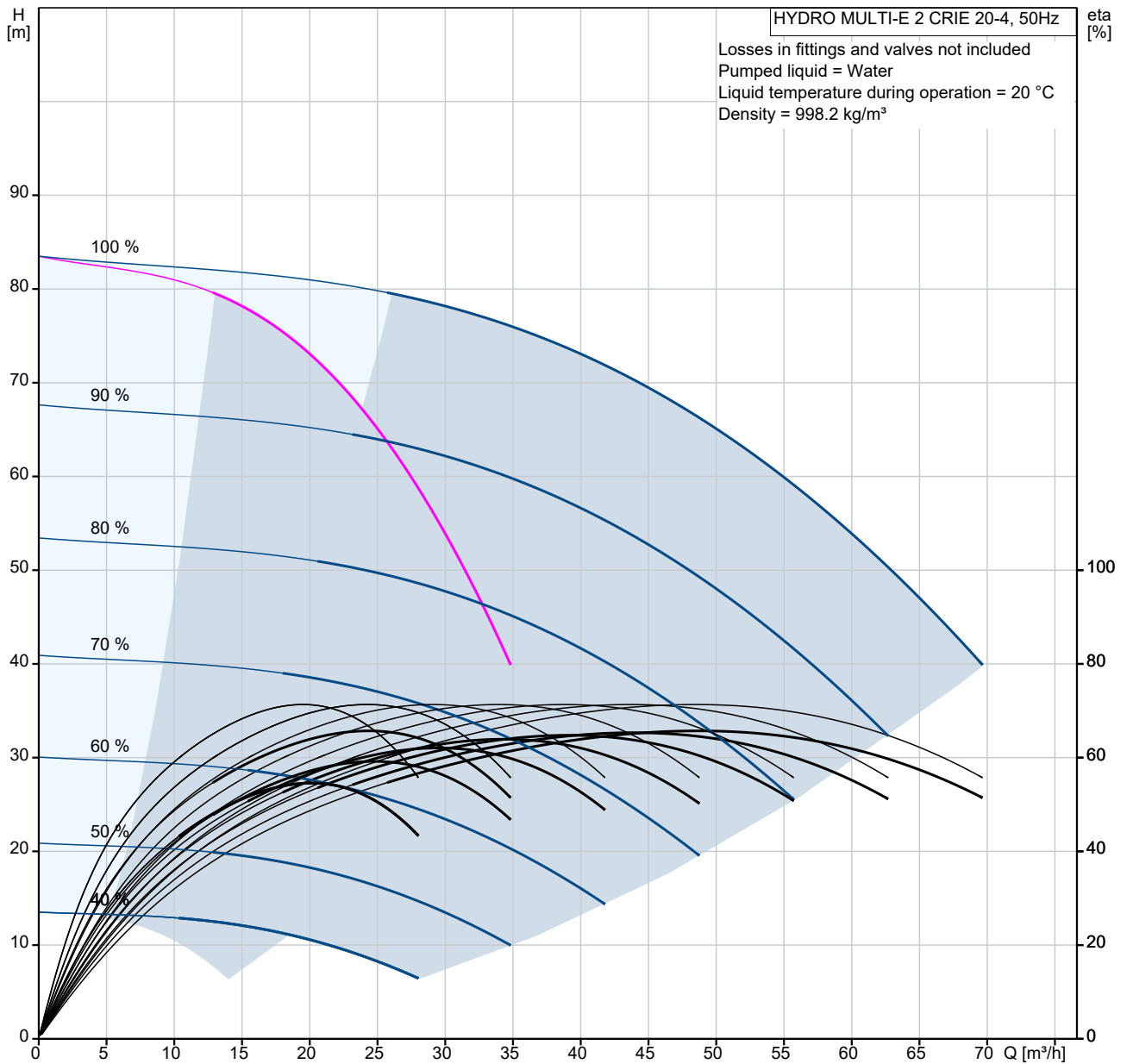

Description	Value
<b>General information:</b>	
Product name:	HYDRO MULTI-E 2 CRIE 20-4
Product No:	99133601
EAN number:	5712607366841
<b>Technical:</b>	
Max flow:	72 m <sup>3</sup> /h
Min flow system:	8.4 m <sup>3</sup> /h
Head max:	85 m
Pump name:	CRIE 20-4
Number of pumps:	2
<b>Materials:</b>	
Pump housing:	Stainless steel
Manifolds:	Stainless steel
<b>Installation:</b>	
Maximum operating pressure:	16 bar
Maximum permissible inlet pressure:	PN 16 bar
<b>Liquid:</b>	
Pumped liquid:	Water
Liquid temperature range:	5 .. 60 °C
Selected liquid temperature:	20 °C
Density:	998.2 kg/m <sup>3</sup>
<b>Electrical data:</b>	
IE Efficiency class:	IE5
Power (P2) main pump:	7.5 kW
Mains frequency:	50 / 60 Hz
Rated voltage:	3 x 380-415 V
Rated current:	27 A
Start. method:	electronically
Enclosure class (IEC 34-5):	IP54
<b>Tank:</b>	
Volume of pressure tank:	25 l
Diaphragm tank:	Yes
<b>Others:</b>	
Net weight:	261 kg
Gross weight:	320 kg
Shipping volume:	1.05 m <sup>3</sup>
Language:	GB
Country of origin:	GB
Custom tariff no.:	84137075

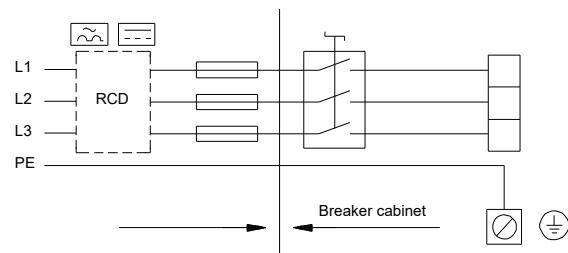
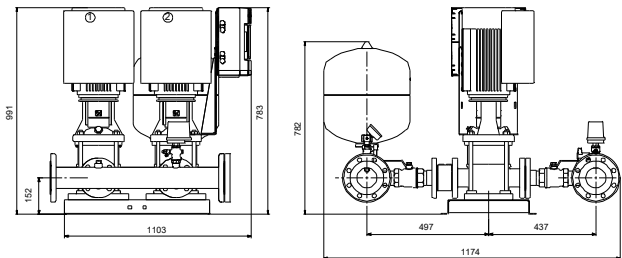
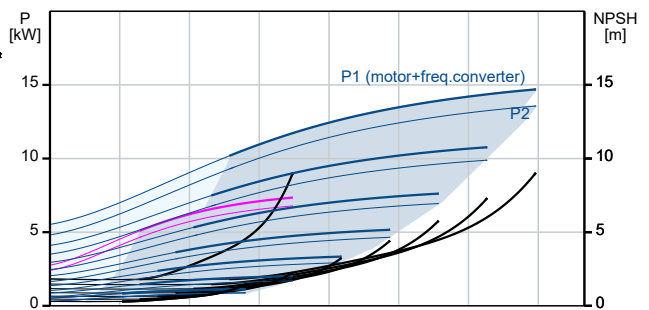
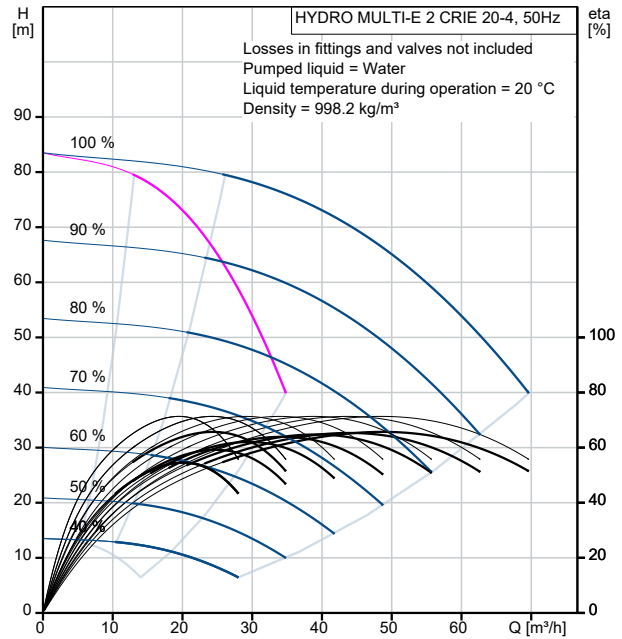

# 99133601 HYDRO MULTI-E 2 CRIE 20-4

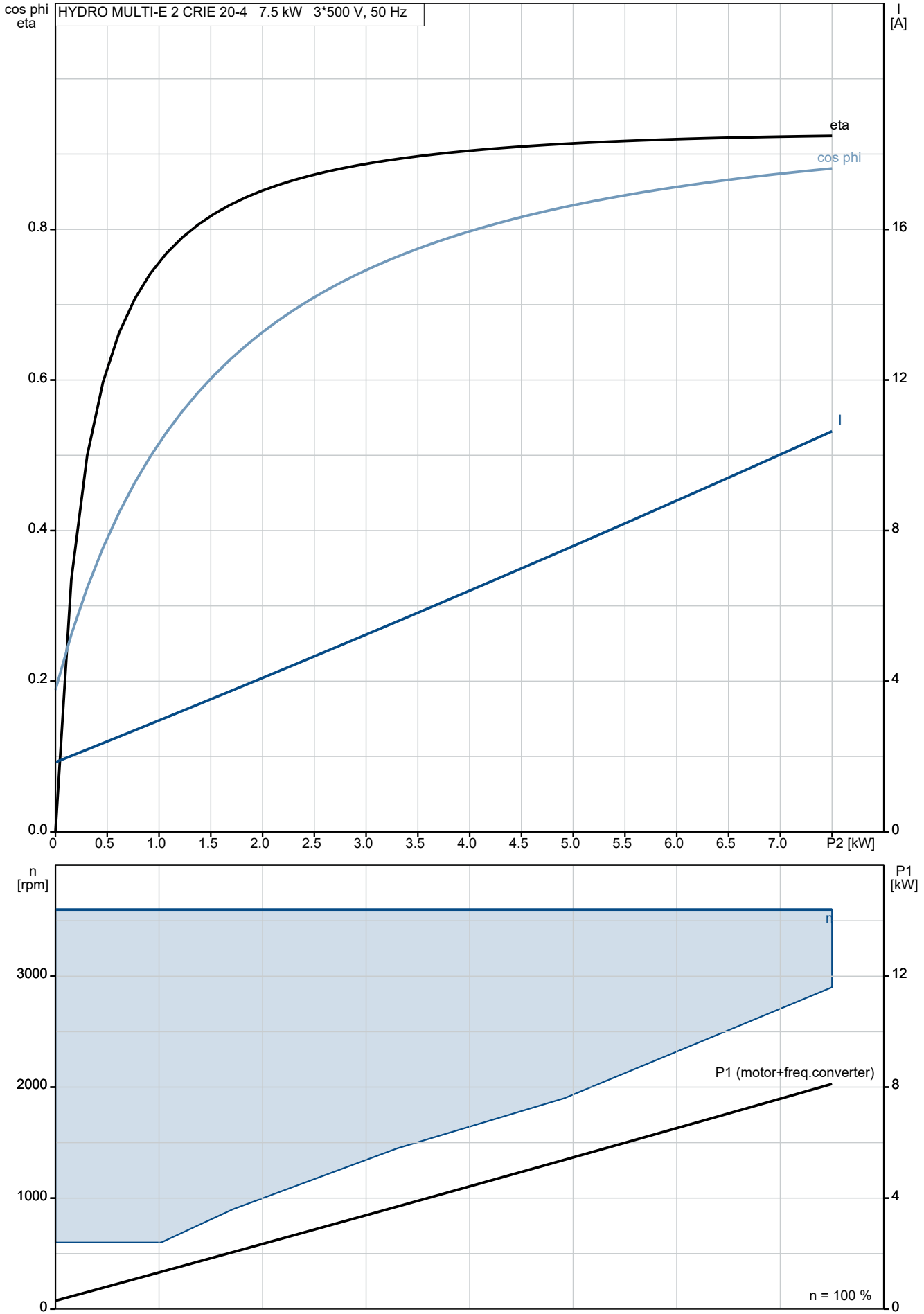

# 99133601 HYDRO MULTI-E 2 CRIE 20-4

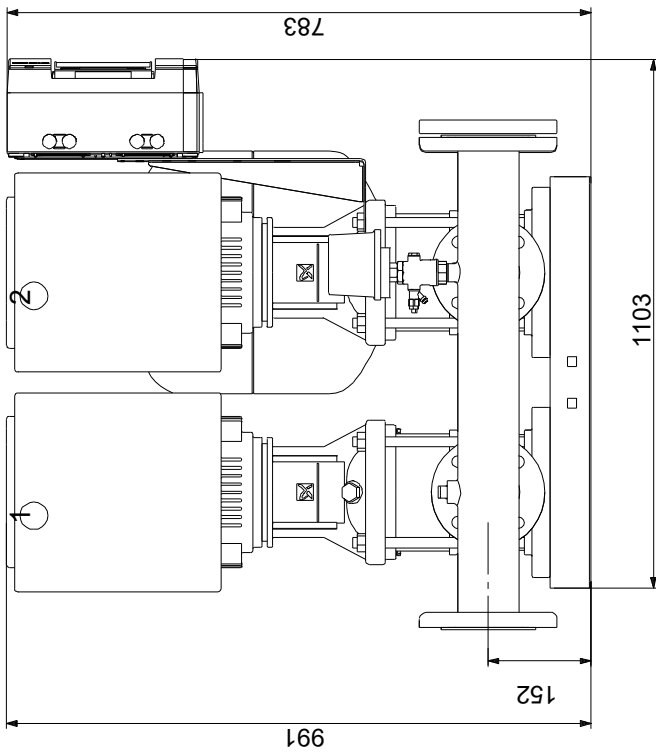
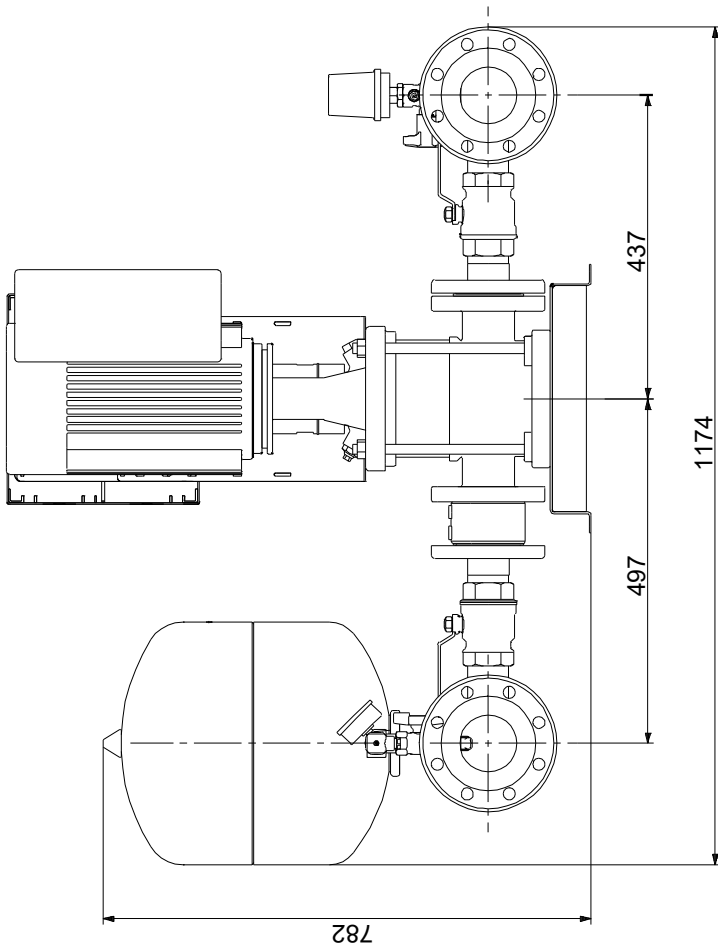

Note! All units are in [mm] unless others are stated.  
Disclaimer: This simplified dimensional drawing does not show all details.

# 99133601 HYDRO MULTI-E 2 CRIE 20-4

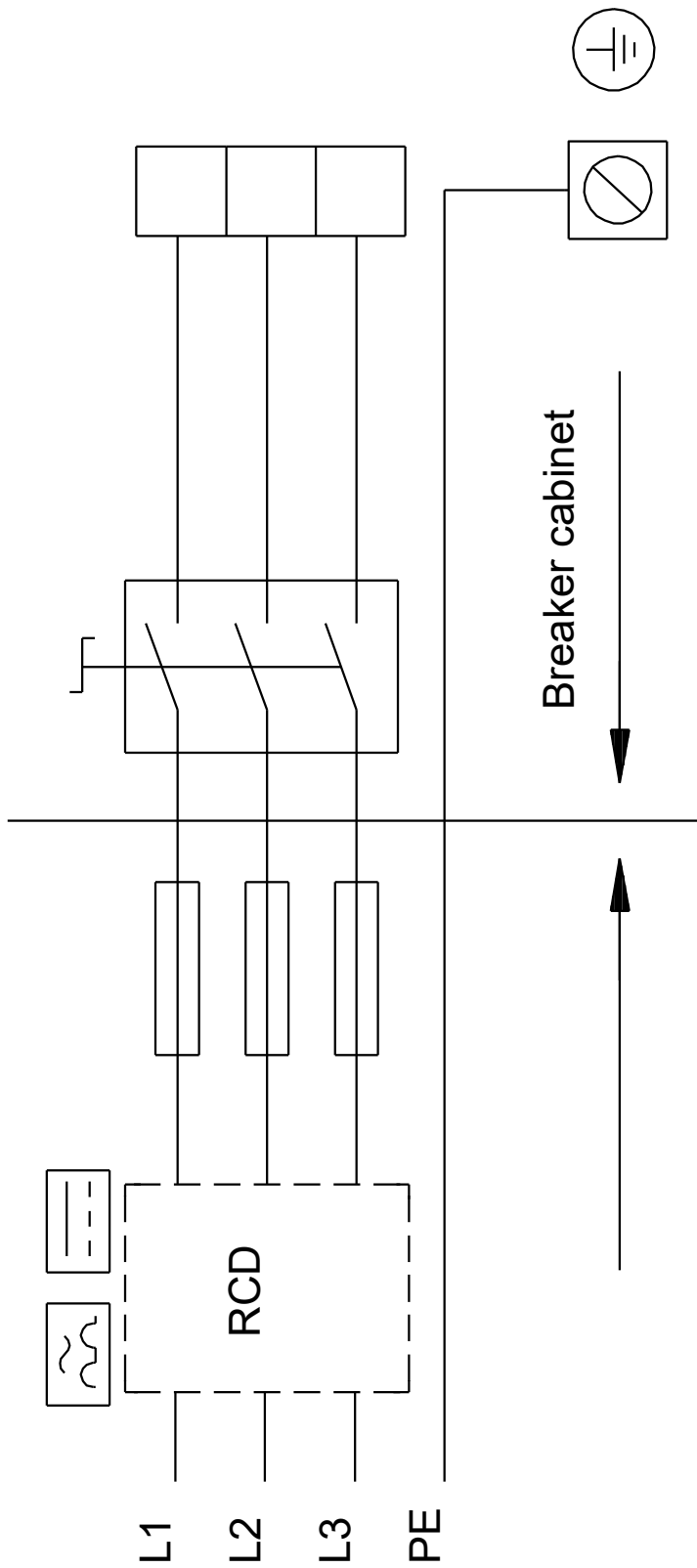

Note! All units are in [mm] unless others are stated.

