

Qty. Description

1 **HYDRO MULTI-E 3 CRIE 15-4**



Note! Product picture may differ from actual product

Product No.: [99133223](#)

GRUNDFOS Hydro Multi-E booster sets are designed for the transfer and pressure boosting of clean water in waterworks, blocks of flats, hotels, industry, hospitals, schools, etc.

GRUNDFOS Hydro Multi-E booster set consists of 2 to 4 CRIE pumps coupled in parallel and mounted on a common base frame provided with all the necessary fittings.

Hydro Multi-E is mounted on a common base frame made of stainless steel (DIN W.-Nr. 1.4301).

On the suction side are fitted a suction manifold (DIN W.-Nr.

1.4401 or DIN W.-Nr.

1.4571) , a pressure switch mounted on a drainable valve and an isolating valve.

On the discharge side of the pumps are fitted a non-return valve, an isolating valve, a pressure gauge, two pressure transmitters mounted on a drainable valve a diaphragm tank and a stainless steel discharge manifold (DIN W.-Nr.

1.4401 or DIN W.-Nr.

1.4571).

The Hydro Multi-E is fitted with an on/off-switch for the supply voltage.

The Hydro Multi-E is designed for maintaining a constant pressure regardless of flow changes and fluctuation.

The internal PI-controller regulates the number of running pumps and the speed of the pumps according to the required flow.

The system can be operated directly on the panel of any of the pumps or via Grundfos GO (available as accessory)

Besides the system features:

2 Digital outputs

2 Digital inputs (one used for dry run protection)

2 Analogue inputs (one used for discharge pressure sensor)

Multi-Master functionality

2 Limit functions

Set-point influence function

Pipe filling function

High efficient PM motors

Available communication protocols:

•LON

•Profibus

•Modbus

•SMS/GSM/GPRS

•GRM

•BACnet

•BACnet IP

•Modbus TCP

•PROFINET

When delivered, the GRUNDFOS Hydro Multi-E booster set is factory tested and ready for operation.

Liquid:

Pumped liquid: Water

Qty.	Description
1	<p>Liquid temperature range: 5 .. 60 °C Selected liquid temperature: 20 °C Density: 998.2 kg/m³</p> <p>Technical: Max flow: 91 m³/h</p> <p>Materials: Pump housing: Stainless steel</p> <p>Installation: Maximum operating pressure: 16 bar Maximum permissible inlet pressure: PN 16 bar Flange standard: DIN2642 Manifold inlet: DN 100 Manifold outlet: DN 100</p> <p>Electrical data: IE Efficiency class: IE5 Power (P2) main pump: 5.5 kW Mains frequency: 50 / 60 Hz Rated voltage: 3 x 380-415 V Rated current: 30 A Start. method: electronically Enclosure class (IEC 34-5): IP54</p> <p>Tank: Volume of pressure tank: 25 l Diaphragm tank: Yes</p> <p>Others: Net weight: 344 kg Gross weight: 430 kg Shipping volume: 1.46 m³ Language: GB Country of origin: GB Custom tariff no.: 84137075</p>

99133223 HYDRO MULTI-E 3 CRIE 15-4

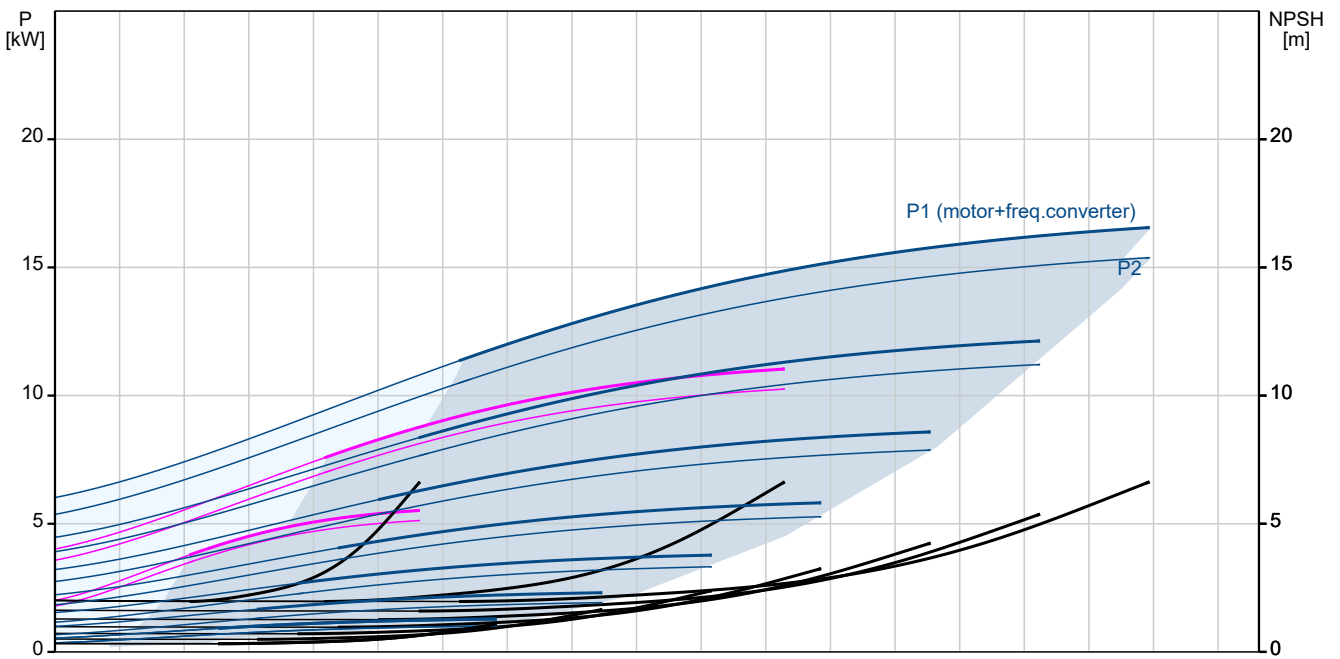
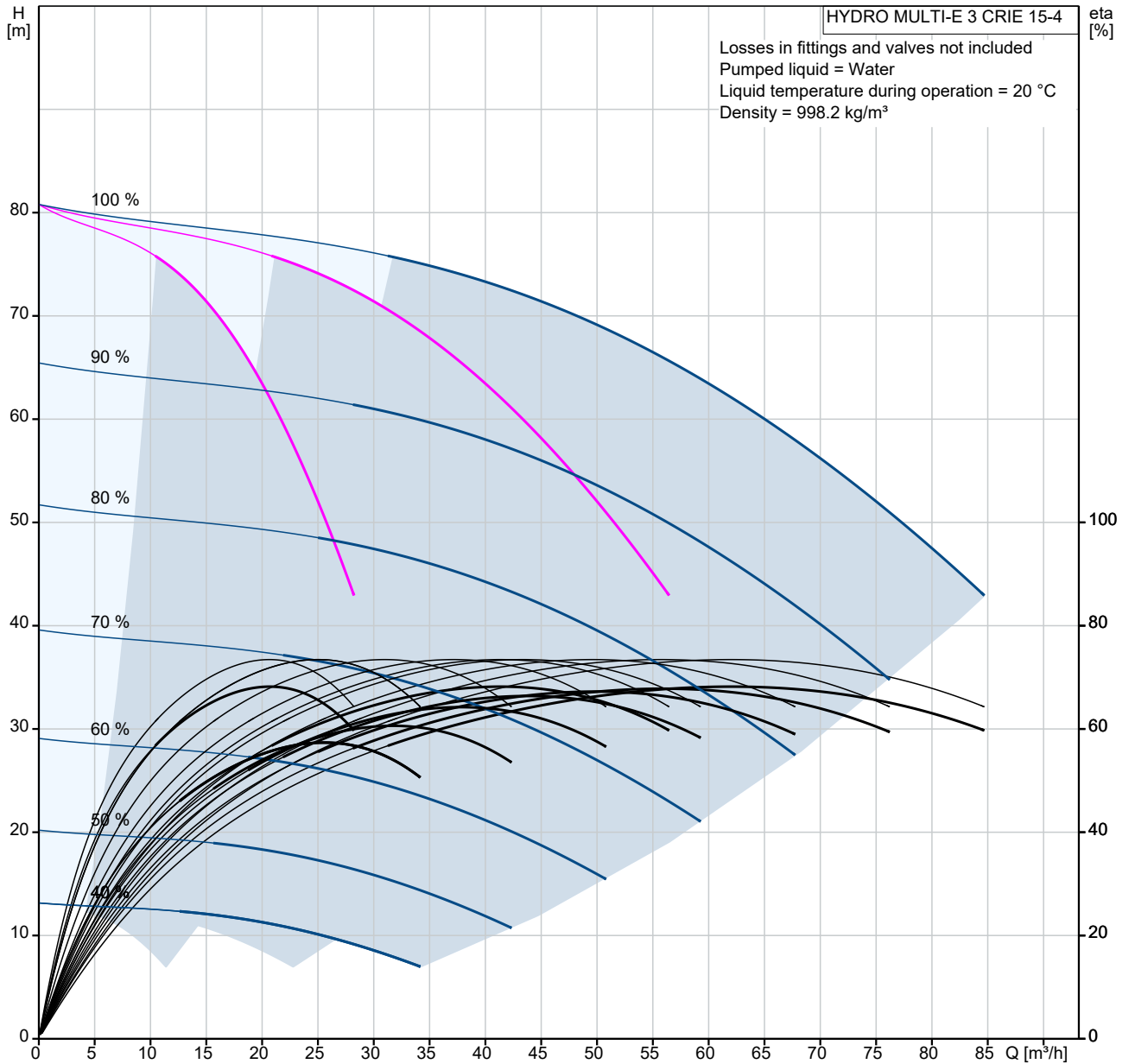

Description	Value
General information:	
Product name:	HYDRO MULTI-E 3 CRIE 15-4
Product No:	99133223
EAN number:	5712607361723
Technical:	
Max flow:	91 m ³ /h
Min flow system:	6 m ³ /h
Head max:	82 m
Pump name:	CRIE 15-4
Number of pumps:	3
Materials:	
Pump housing:	Stainless steel
Manifolds:	Stainless steel
Installation:	
Maximum operating pressure:	16 bar
Maximum permissible inlet pressure:	PN 16 bar
Liquid:	
Pumped liquid:	Water
Liquid temperature range:	5 .. 60 °C
Selected liquid temperature:	20 °C
Density:	998.2 kg/m ³
Electrical data:	
IE Efficiency class:	IE5
Power (P2) main pump:	5.5 kW
Mains frequency:	50 / 60 Hz
Rated voltage:	3 x 380-415 V
Rated current:	30 A
Start. method:	electronically
Enclosure class (IEC 34-5):	IP54
Tank:	
Volume of pressure tank:	25 l
Diaphragm tank:	Yes
Others:	
Net weight:	344 kg
Gross weight:	430 kg
Shipping volume:	1.46 m ³
Language:	GB
Country of origin:	GB
Custom tariff no.:	84137075

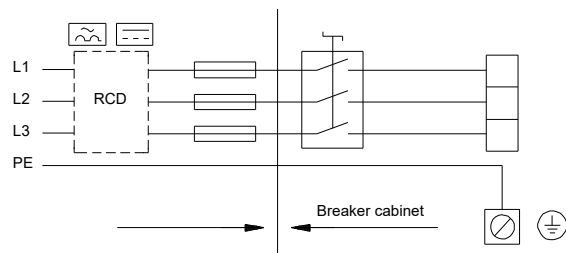
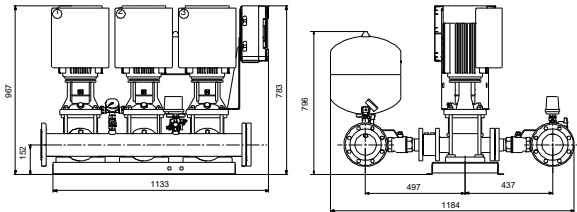
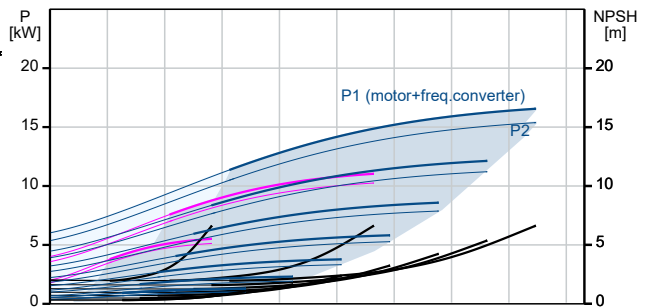
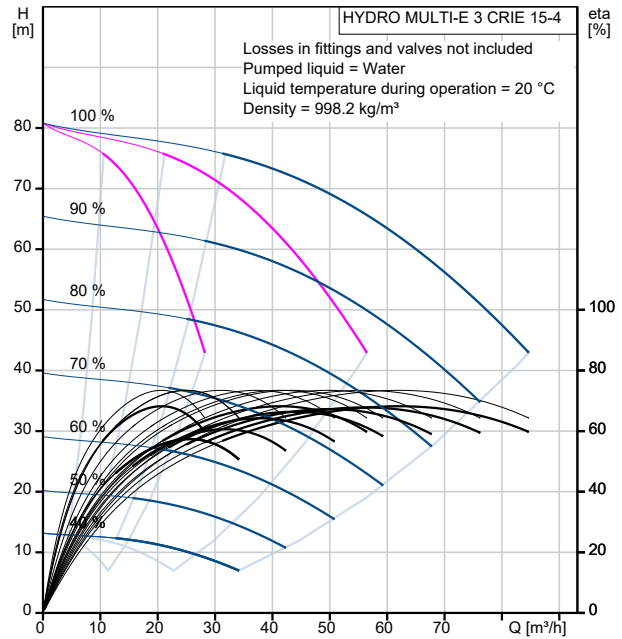

99133223 HYDRO MULTI-E 3 CRIE 15-4

HYDRO MULTI-E 3 CRIE 15-4 5.5 kW 3*500 V, 50 Hz

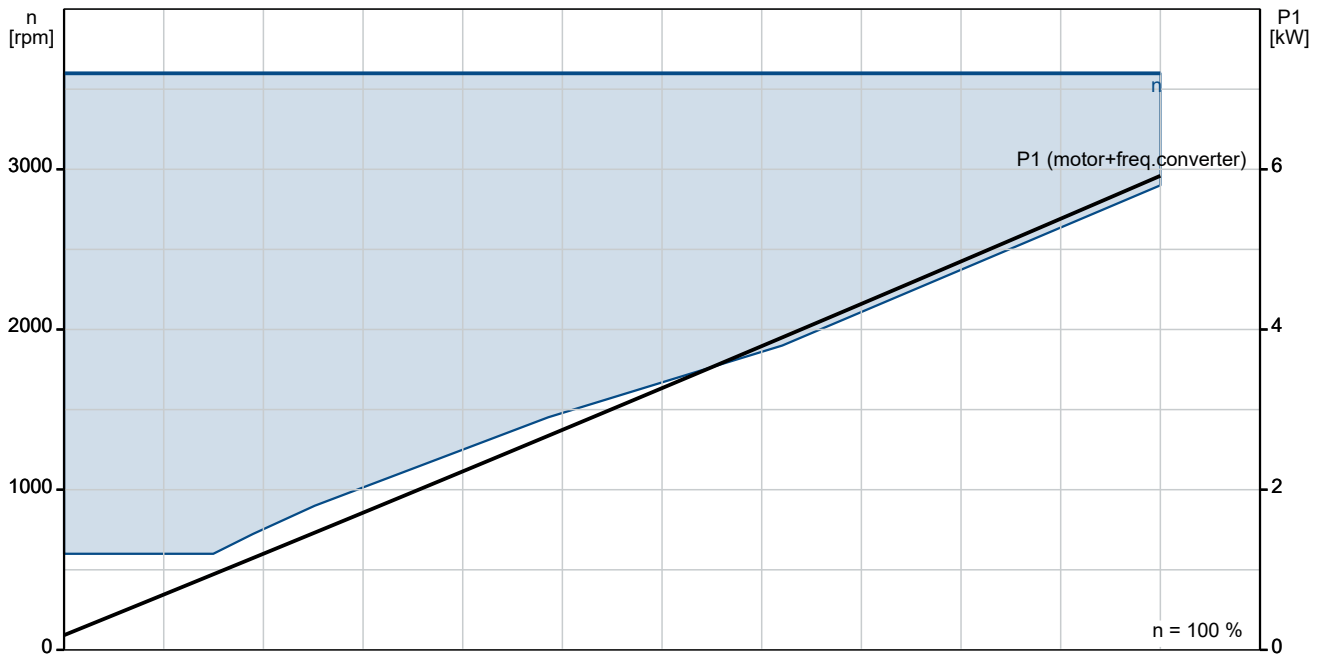
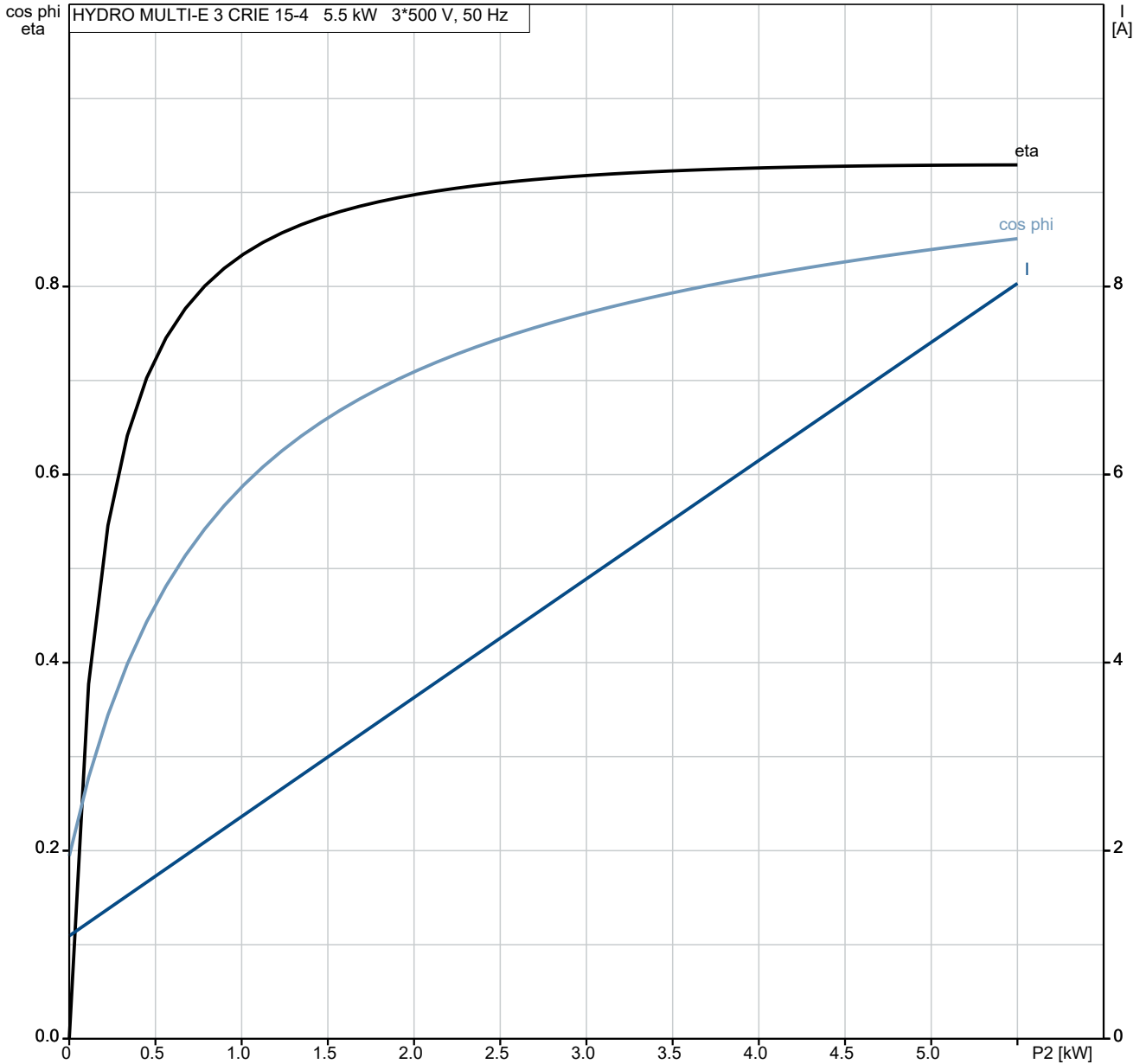

99133223 HYDRO MULTI-E 3 CRIE 15-4

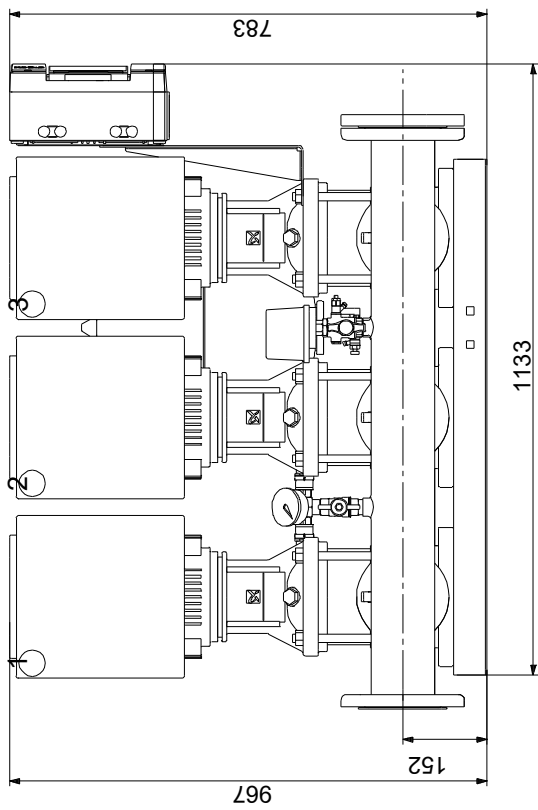
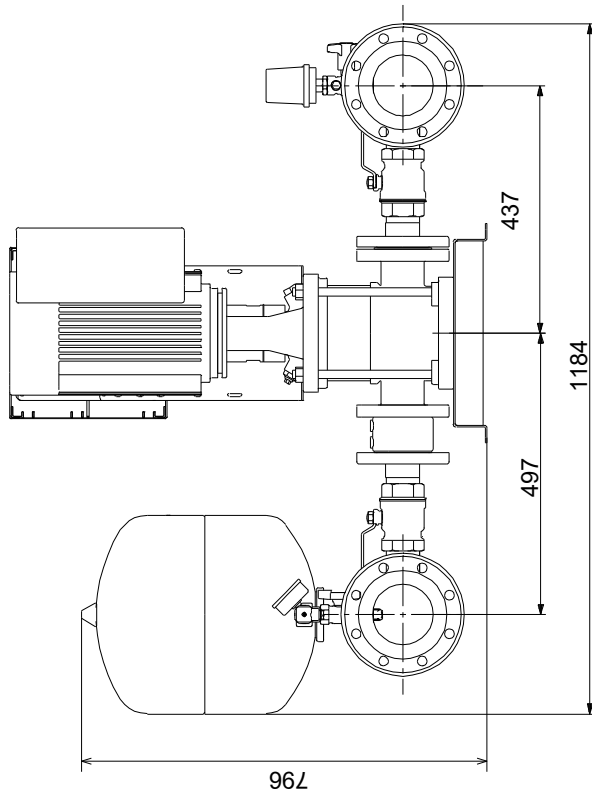

Note! All units are in [mm] unless others are stated.
Disclaimer: This simplified dimensional drawing does not show all details.

99133223 HYDRO MULTI-E 3 CRIE 15-4

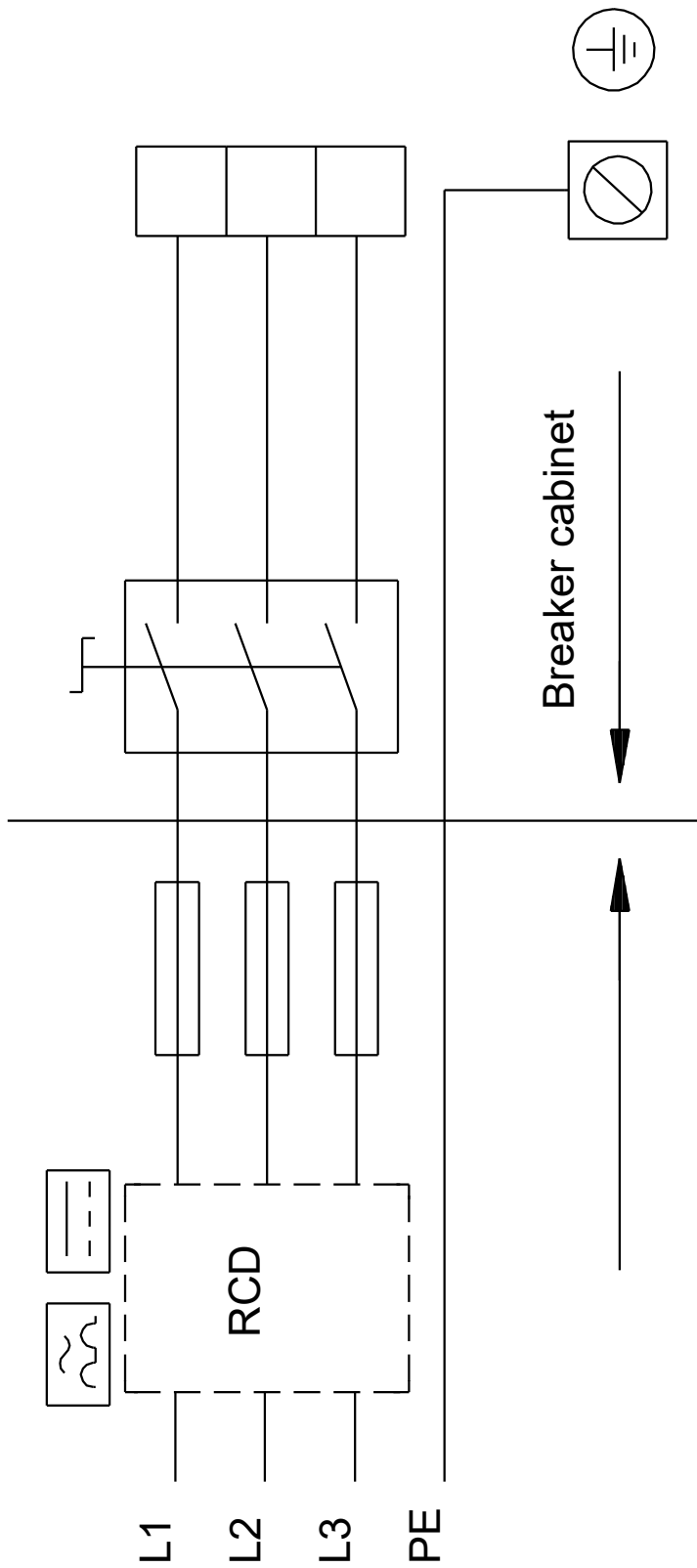

Note! All units are in [mm] unless others are stated.

Order Data:

Position	Your pos.	Product name	Amount	Product No	Total
		HYDRO MULTI-E 3 CRIE 15-4	1	99133223	Price on request