

Qty.	Description
1	<p data-bbox="199 159 539 190">HYDRO MULTI-E 4 CRIE 10-6</p>  <p data-bbox="592 506 1062 533" style="text-align: center;">Note! Product picture may differ from actual product</p> <p data-bbox="199 539 464 566">Product No.: 99133139</p> <p data-bbox="199 600 1372 651">GRUNDFOS Hydro Multi-E booster sets are designed for the transfer and pressure boosting of clean water in waterworks, blocks of flats, hotels, industry, hospitals, schools, etc.</p> <p data-bbox="199 658 1455 710">GRUNDFOS Hydro Multi-E booster set consists of 2 to 4 CRIE pumps coupled in parallel and mounted on a common base frame provided with all the necessary fittings.</p> <p data-bbox="199 743 1235 770">Hydro Multi-E is mounted on a common base frame made of stainless steel (DIN W.-Nr. 1.4301).</p> <p data-bbox="199 777 845 804">On the suction side are fitted a suction manifold (DIN W.-Nr.</p> <p data-bbox="199 810 432 837">1.4401 or DIN W.-Nr.</p> <p data-bbox="199 844 1062 871">1.4571) , a pressure switch mounted on a drainable valve and an isolating valve.</p> <p data-bbox="199 878 1437 929">On the discharge side of the pumps are fitted a non-return valve, an isolating valve, a pressure gauge, two pressure transmitters mounted on a drainable valve a diaphragm tank and a stainless steel discharge manifold (DIN W.-Nr.</p> <p data-bbox="199 958 432 985">1.4401 or DIN W.-Nr.</p> <p data-bbox="199 992 293 1019">1.4571).</p> <p data-bbox="199 1025 948 1052">The Hydro Multi-E is fitted with an on/off-switch for the supply voltage.</p> <p data-bbox="199 1081 1374 1108">The Hydro Multi-E is designed for maintaining a constant pressure regardless of flow changes and fluctuation.</p> <p data-bbox="199 1137 1382 1189">The internal PI-controller regulates the number of running pumps and the speed of the pumps according to the required flow.</p> <p data-bbox="199 1218 1434 1245">The system can be operated directly on the panel of any of the pumps or via Grundfos GO (available as accessory)</p> <p data-bbox="199 1305 513 1332">Besides the system features:</p> <ul data-bbox="199 1339 847 1570" style="list-style-type: none"> 2 Digital outputs 2 Digital inputs (one used for dry run protection) 2 Analogue inputs (one used for discharge pressure sensor) Multi-Master functionality 2 Limit functions Set-point influence function Pipe filling function High efficient PM motors <p data-bbox="199 1599 584 1626">Available communication protocols:</p> <ul data-bbox="199 1632 403 1899" style="list-style-type: none"> •LON •Profibus •Modbus •SMS/GSM/GPRS •GRM •BACnet •BACnet IP •Modbus TCP •PROFINET <p data-bbox="199 1933 1281 1960">When delivered, the GRUNDFOS Hydro Multi-E booster set is factory tested and ready for operation.</p> <p data-bbox="199 2022 633 2078">Liquid: Pumped liquid: Water</p>

Qty.	Description
1	<p>Liquid temperature range: 5 .. 60 °C Selected liquid temperature: 20 °C Density: 998.2 kg/m³</p> <p>Technical: Max flow: 72 m³/h</p> <p>Materials: Pump housing: Stainless steel</p> <p>Installation: Maximum operating pressure: 16 bar Maximum permissible inlet pressure: PN 16 bar Flange standard: DIN2642 Manifold inlet: DN 80 Manifold outlet: DN 80</p> <p>Electrical data: IE Efficiency class: IE5 Power (P2) main pump: 4 kW Mains frequency: 50 / 60 Hz Rated voltage: 3 x 380-415 V Rated current: 29 A Start. method: electronically Enclosure class (IEC 34-5): IP54</p> <p>Tank: Volume of pressure tank: 12 l Diaphragm tank: Yes</p> <p>Others: Net weight: 329 kg Gross weight: 417 kg Shipping volume: 1.41 m³ Language: GB Country of origin: GB Custom tariff no.: 84137075</p>

99133139 HYDRO MULTI-E 4 CRIE 10-6

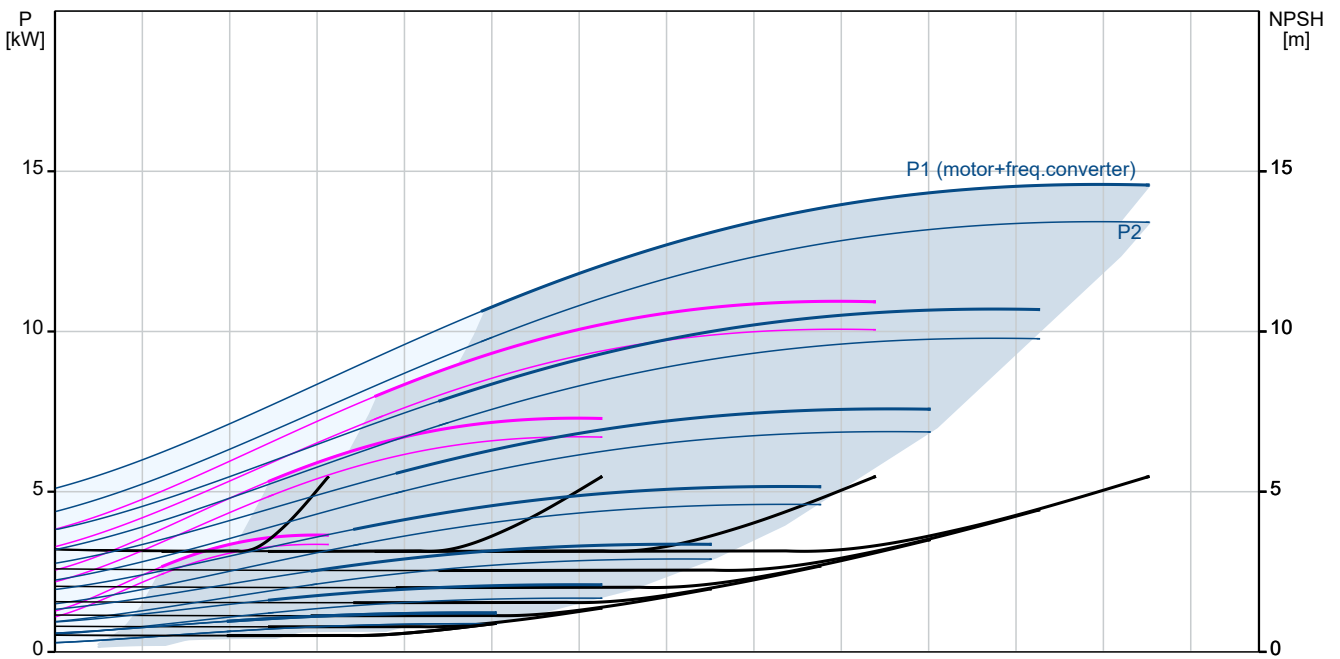
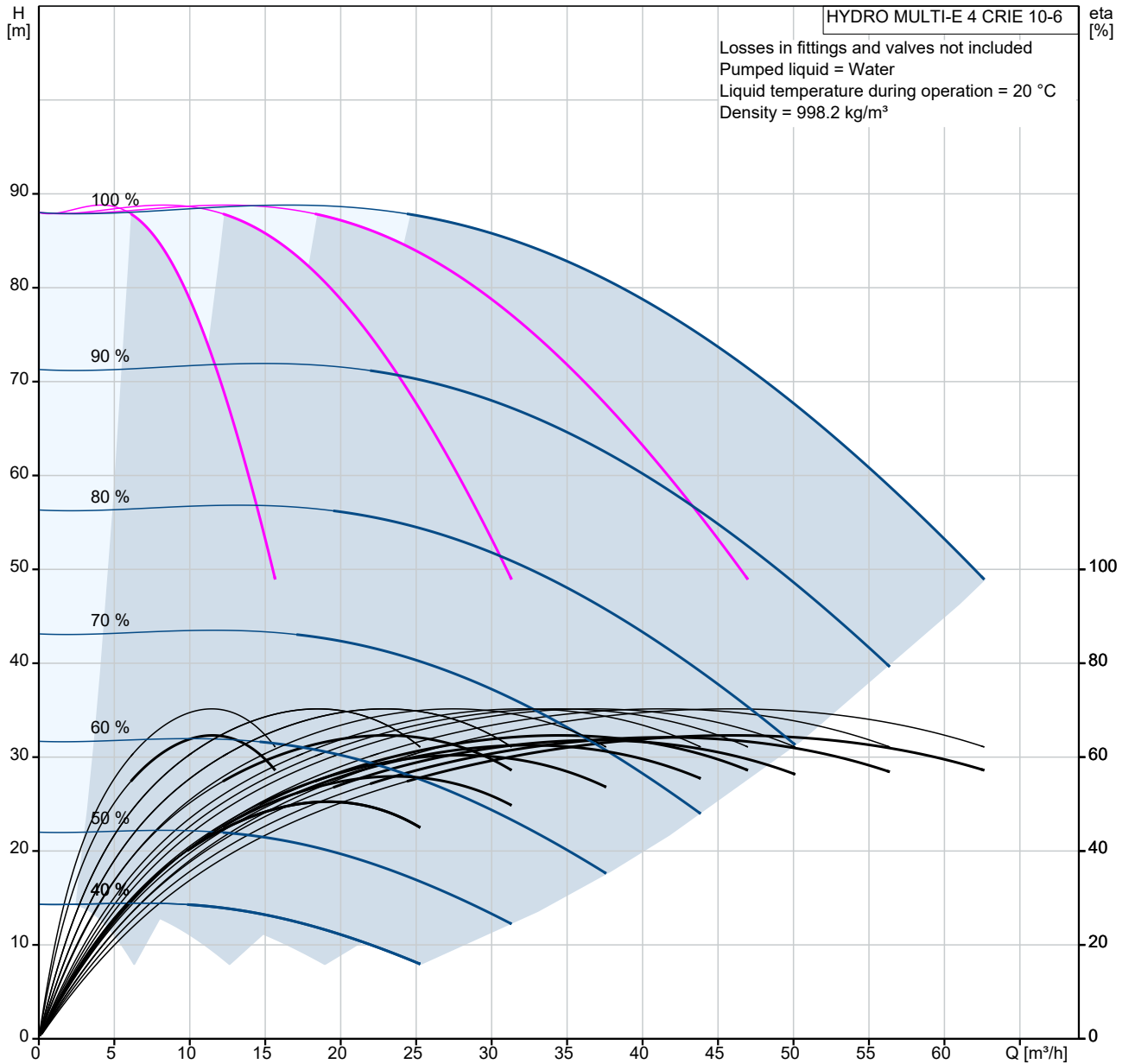

Description	Value
General information:	
Product name:	HYDRO MULTI-E 4 CRIE 10-6
Product No:	99133139
EAN number:	5712607360573
Technical:	
Max flow:	72 m ³ /h
Min flow system:	4.8 m ³ /h
Head max:	89 m
Pump name:	CRIE 10-6
Number of pumps:	4
Materials:	
Pump housing:	Stainless steel
Manifolds:	Stainless steel
Installation:	
Maximum operating pressure:	16 bar
Maximum permissible inlet pressure:	PN 16 bar
Liquid:	
Pumped liquid:	Water
Liquid temperature range:	5 .. 60 °C
Selected liquid temperature:	20 °C
Density:	998.2 kg/m ³
Electrical data:	
IE Efficiency class:	IE5
Power (P2) main pump:	4 kW
Mains frequency:	50 / 60 Hz
Rated voltage:	3 x 380-415 V
Rated current:	29 A
Start. method:	electronically
Enclosure class (IEC 34-5):	IP54
Tank:	
Volume of pressure tank:	12 l
Diaphragm tank:	Yes
Others:	
Net weight:	329 kg
Gross weight:	417 kg
Shipping volume:	1.41 m ³
Language:	GB
Country of origin:	GB
Custom tariff no.:	84137075

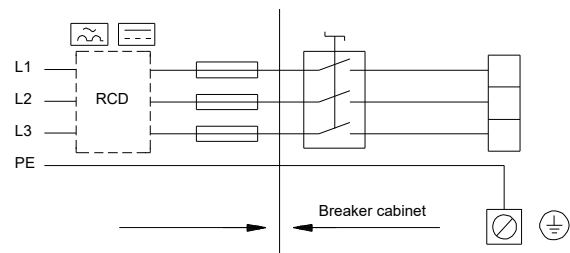
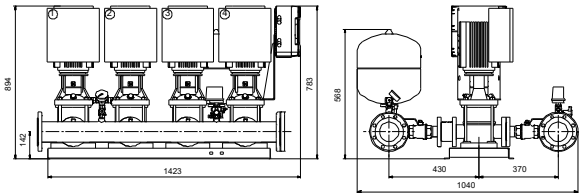
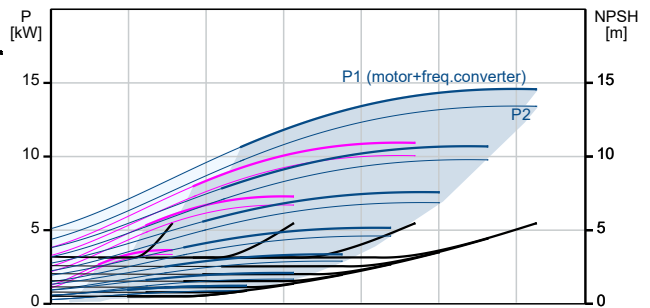
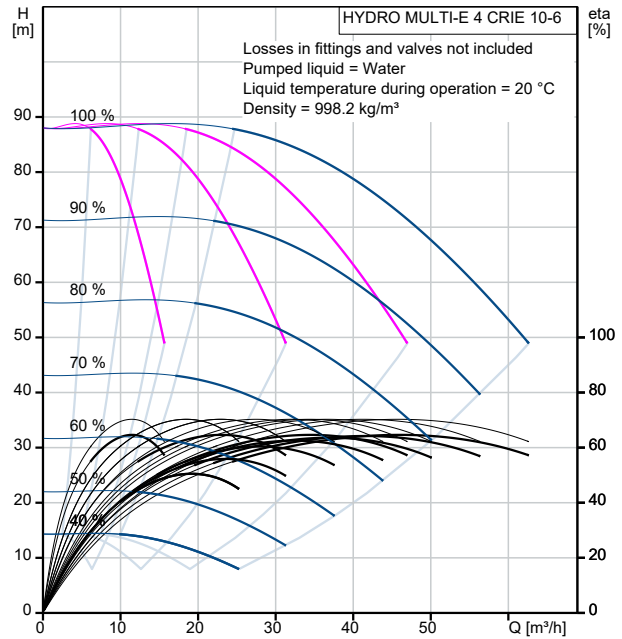

99133139 HYDRO MULTI-E 4 CRIE 10-6

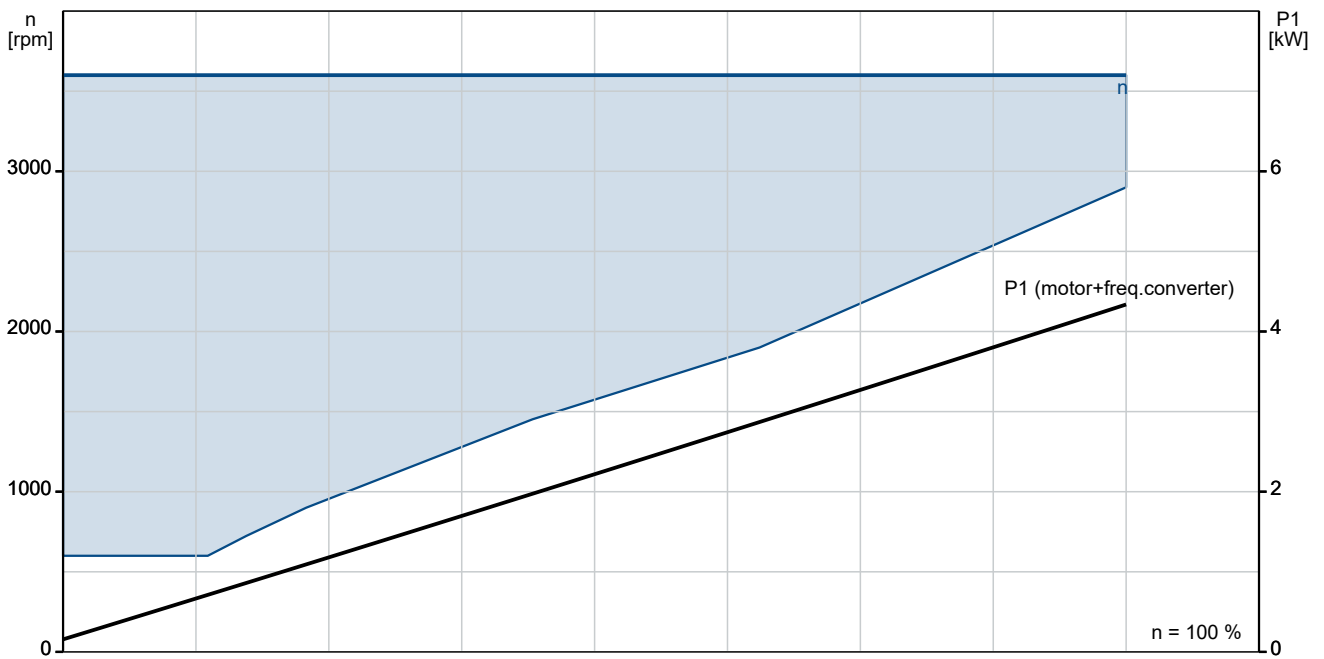
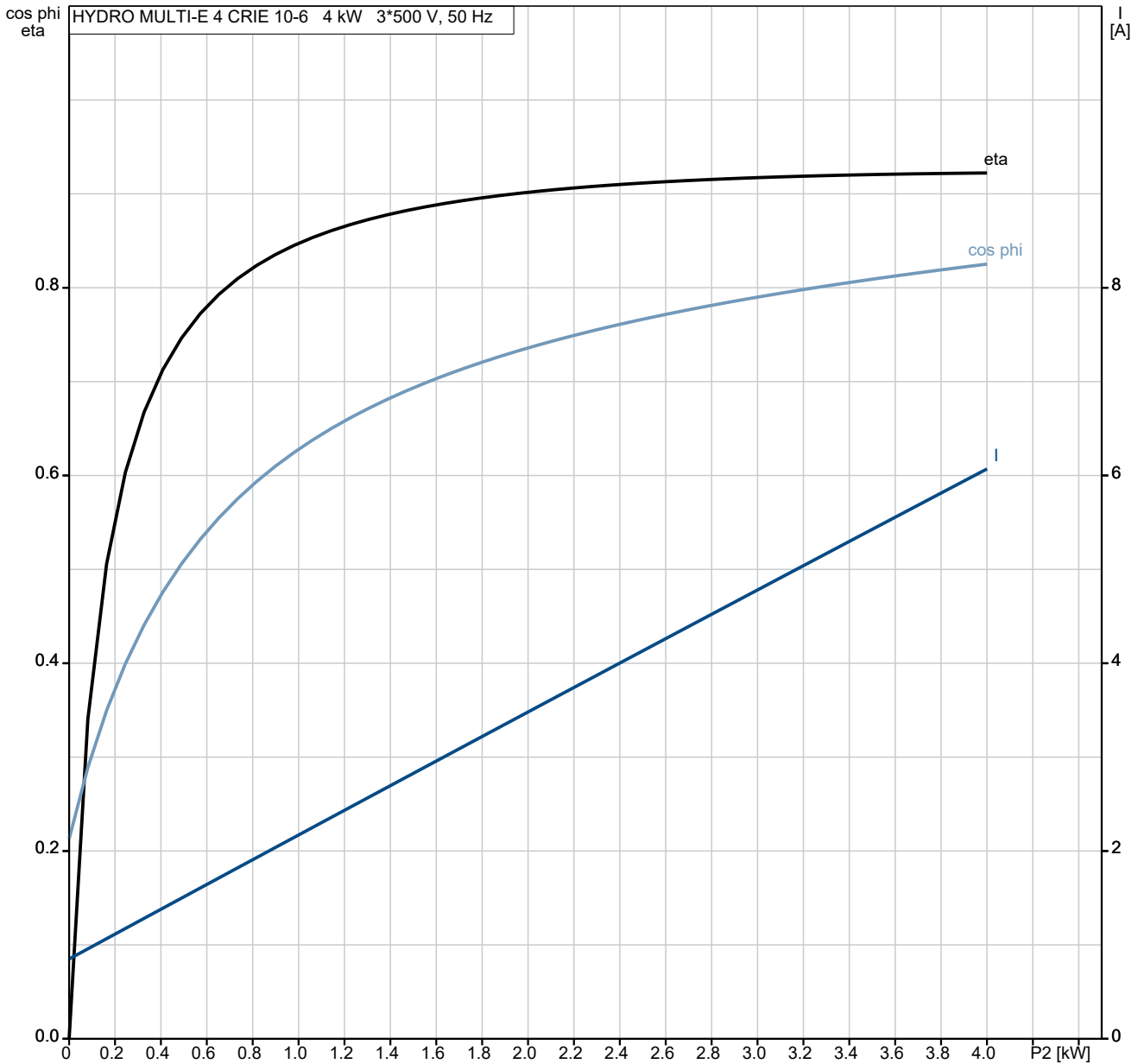

99133139 HYDRO MULTI-E 4 CRIE 10-6

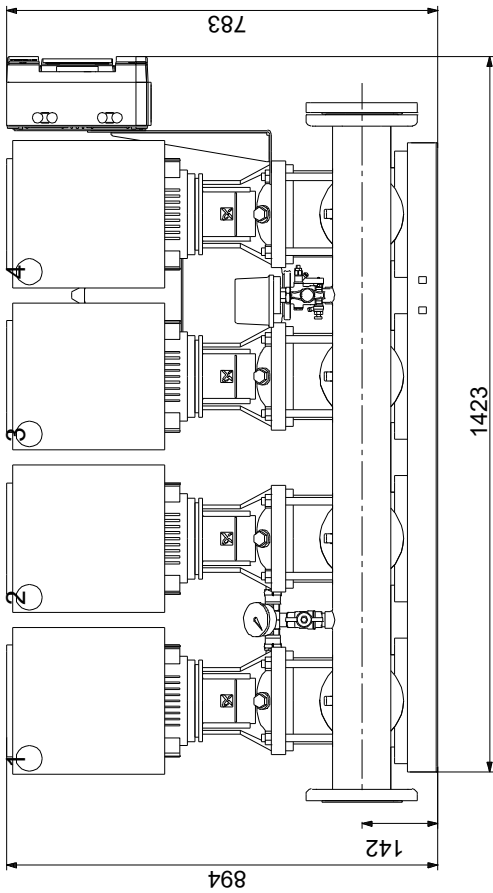
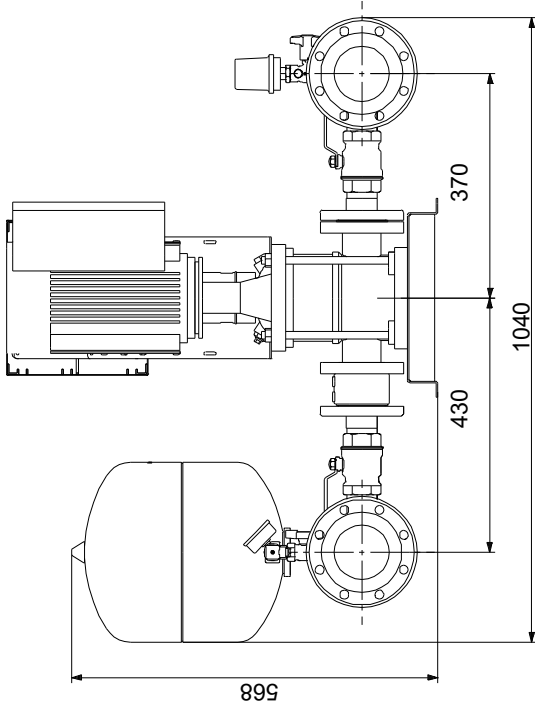

Note! All units are in [mm] unless others are stated.
Disclaimer: This simplified dimensional drawing does not show all details.

99133139 HYDRO MULTI-E 4 CRIE 10-6

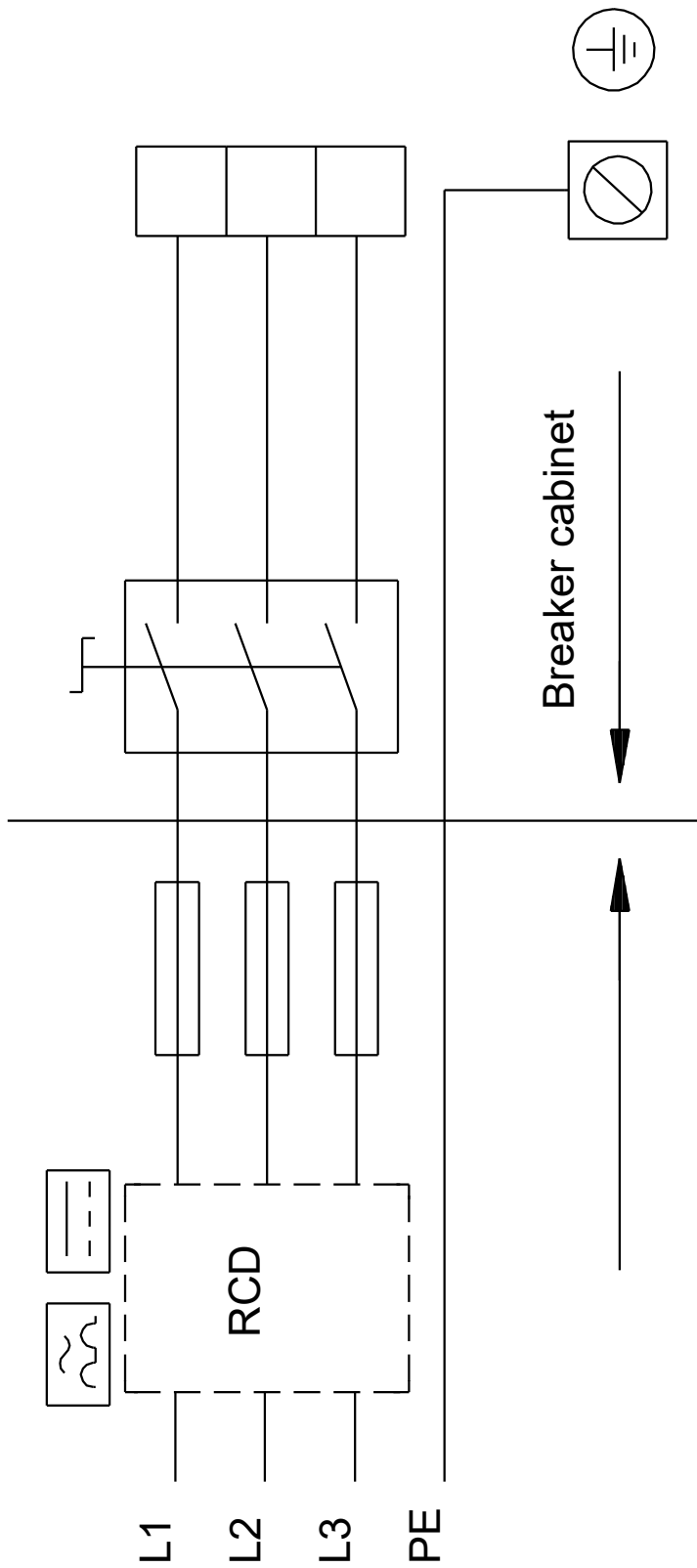

Note! All units are in [mm] unless others are stated.

Order Data:

Position	Your pos.	Product name	Amount	Product No	Total
		HYDRO MULTI-E 4 CRIE 10-6	1	99133139	Price on request