

Qty.	Description
1	<p data-bbox="199 159 539 190"><b>HYDRO MULTI-E 4 CRIE 15-7</b></p>  <p data-bbox="592 506 1064 533" style="text-align: center;"><b>Note! Product picture may differ from actual product</b></p> <p data-bbox="199 539 466 566">Product No.: <a href="#">99132963</a></p> <p data-bbox="199 600 1372 651">GRUNDFOS Hydro Multi-E booster sets are designed for the transfer and pressure boosting of clean water in waterworks, blocks of flats, hotels, industry, hospitals, schools, etc.</p> <p data-bbox="199 658 1455 710">GRUNDFOS Hydro Multi-E booster set consists of 2 to 4 CRIE pumps coupled in parallel and mounted on a common base frame provided with all the necessary fittings.</p> <p data-bbox="199 743 1235 770">Hydro Multi-E is mounted on a common base frame made of stainless steel (DIN W.-Nr. 1.4301).</p> <p data-bbox="199 777 845 804">On the suction side are fitted a suction manifold (DIN W.-Nr.</p> <p data-bbox="199 810 432 837">1.4401 or DIN W.-Nr.</p> <p data-bbox="199 844 1062 871">1.4571) , a pressure switch mounted on a drainable valve and an isolating valve.</p> <p data-bbox="199 878 1437 929">On the discharge side of the pumps are fitted a non-return valve, an isolating valve, a pressure gauge, two pressure transmitters mounted on a drainable valve a diaphragm tank and a stainless steel discharge manifold (DIN W.-Nr.</p> <p data-bbox="199 958 432 985">1.4401 or DIN W.-Nr.</p> <p data-bbox="199 992 293 1019">1.4571).</p> <p data-bbox="199 1025 948 1052">The Hydro Multi-E is fitted with an on/off-switch for the supply voltage.</p> <p data-bbox="199 1081 1374 1108">The Hydro Multi-E is designed for maintaining a constant pressure regardless of flow changes and fluctuation.</p> <p data-bbox="199 1137 1382 1189">The internal PI-controller regulates the number of running pumps and the speed of the pumps according to the required flow.</p> <p data-bbox="199 1218 1434 1245">The system can be operated directly on the panel of any of the pumps or via Grundfos GO (available as accessory)</p> <p data-bbox="199 1305 513 1332">Besides the system features:</p> <ul style="list-style-type: none"> <li data-bbox="199 1339 379 1366">2 Digital outputs</li> <li data-bbox="199 1373 715 1400">2 Digital inputs (one used for dry run protection)</li> <li data-bbox="199 1406 845 1433">2 Analogue inputs (one used for discharge pressure sensor)</li> <li data-bbox="199 1440 472 1467">Multi-Master functionality</li> <li data-bbox="199 1473 379 1500">2 Limit functions</li> <li data-bbox="199 1507 496 1534">Set-point influence function</li> <li data-bbox="199 1541 405 1568">Pipe filling function</li> <li data-bbox="199 1574 467 1601">High efficient PM motors</li> </ul> <p data-bbox="199 1630 584 1657">Available communication protocols:</p> <ul style="list-style-type: none"> <li data-bbox="199 1664 261 1691">•LON</li> <li data-bbox="199 1697 301 1724">•Profibus</li> <li data-bbox="199 1731 301 1758">•Modbus</li> <li data-bbox="199 1765 400 1792">•SMS/GSM/GPRS</li> <li data-bbox="199 1798 269 1825">•GRM</li> <li data-bbox="199 1832 300 1859">•BACnet</li> <li data-bbox="199 1865 325 1892">•BACnet IP</li> <li data-bbox="199 1899 352 1926">•Modbus TCP</li> <li data-bbox="199 1933 333 1960">•PROFINET</li> </ul> <p data-bbox="199 1989 1278 2016">When delivered, the GRUNDFOS Hydro Multi-E booster set is factory tested and ready for operation.</p> <p data-bbox="199 2045 632 2083">Liquid: Pumped liquid:                      Water</p>

Qty.	Description
1	<p>Liquid temperature range: 5 .. 60 °C  Selected liquid temperature: 20 °C  Density: 998.2 kg/m<sup>3</sup></p> <p>Technical:  Max flow: 121 m<sup>3</sup>/h</p> <p>Materials:  Pump housing: Stainless steel</p> <p>Installation:  Maximum operating pressure: 16 bar  Maximum permissible inlet pressure: PN 16 bar  Flange standard: DIN2642  Manifold inlet: DN 100  Manifold outlet: DN 100</p> <p>Electrical data:  IE Efficiency class: IE5  Power (P2) main pump: 7.5 kW  Mains frequency: 50 / 60 Hz  Rated voltage: 3 x 380-415 V  Rated current: 54 A  Start. method: electronically  Enclosure class (IEC 34-5): IP54</p> <p>Tank:  Volume of pressure tank: 25 l  Diaphragm tank: Yes</p> <p>Others:  Net weight: 507 kg  Gross weight: 621 kg  Shipping volume: 3.06 m<sup>3</sup>  Language: GB  Country of origin: GB  Custom tariff no.: 84137075</p>

# 99132963 HYDRO MULTI-E 4 CRIE 15-7

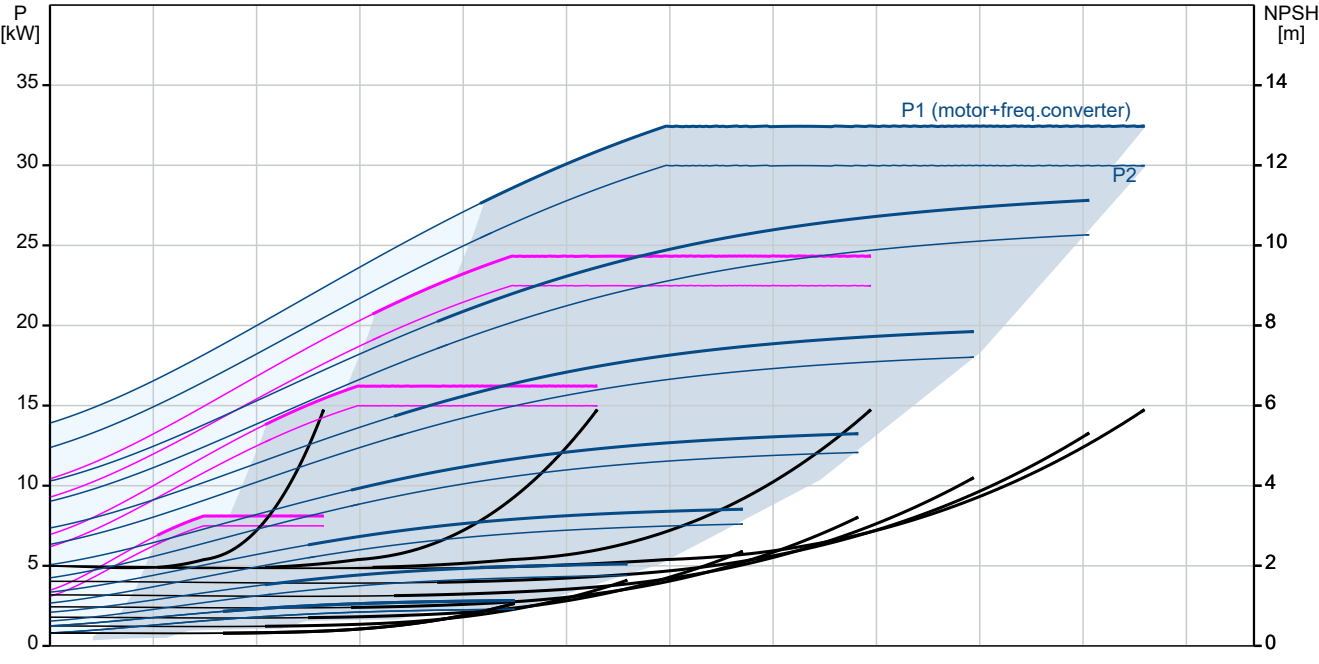
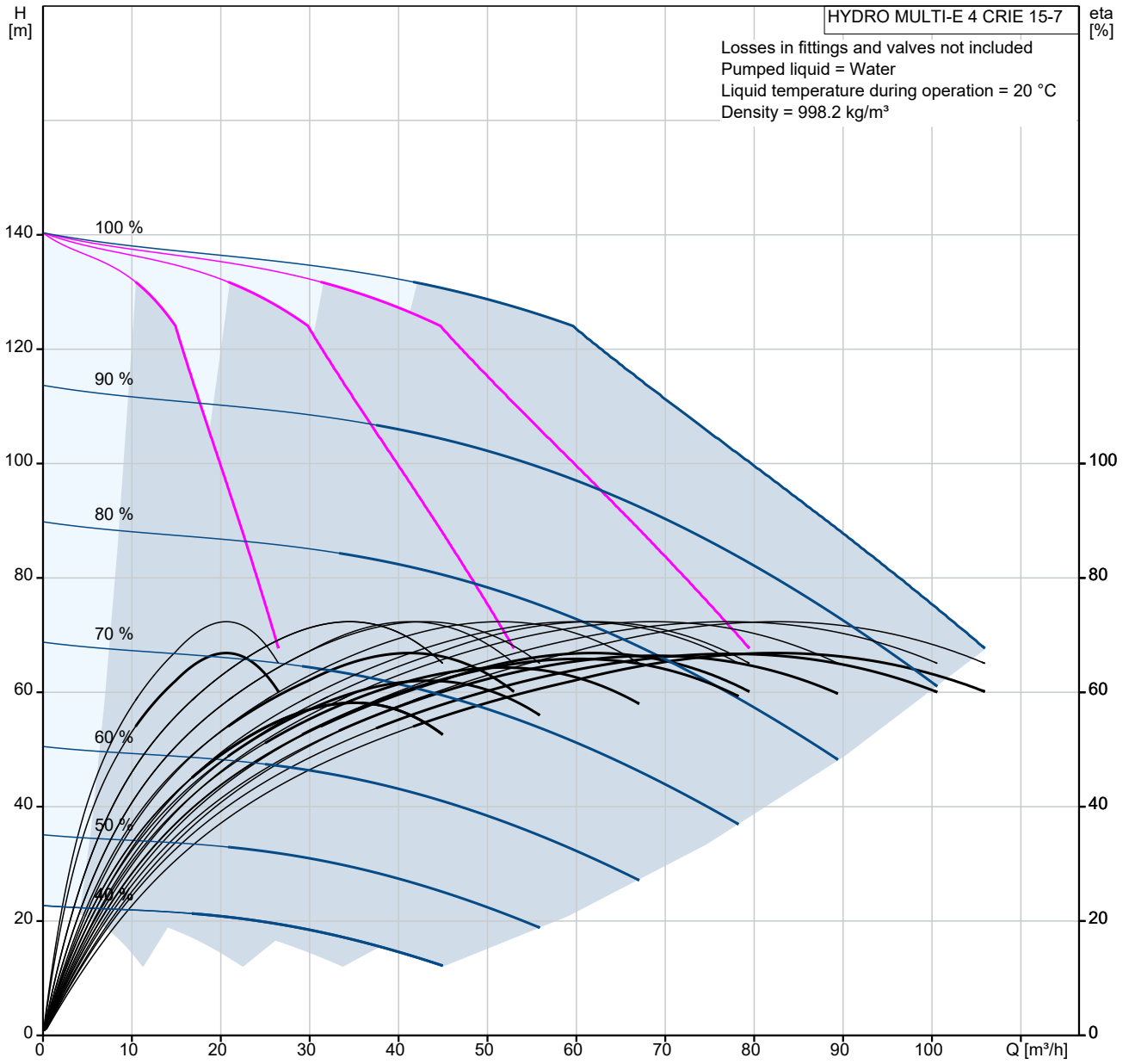

Description	Value
<b>General information:</b>	
Product name:	HYDRO MULTI-E 4 CRIE 15-7
Product No:	99132963
EAN number:	5712607357214
<b>Technical:</b>	
Max flow:	121 m <sup>3</sup> /h
Min flow system:	6 m <sup>3</sup> /h
Head max:	143 m
Pump name:	CRIE 15-7
Number of pumps:	4
<b>Materials:</b>	
Pump housing:	Stainless steel
Manifolds:	Stainless steel
<b>Installation:</b>	
Maximum operating pressure:	16 bar
Maximum permissible inlet pressure:	PN 16 bar
<b>Liquid:</b>	
Pumped liquid:	Water
Liquid temperature range:	5 .. 60 °C
Selected liquid temperature:	20 °C
Density:	998.2 kg/m <sup>3</sup>
<b>Electrical data:</b>	
IE Efficiency class:	IE5
Power (P2) main pump:	7.5 kW
Mains frequency:	50 / 60 Hz
Rated voltage:	3 x 380-415 V
Rated current:	54 A
Start. method:	electronically
Enclosure class (IEC 34-5):	IP54
<b>Tank:</b>	
Volume of pressure tank:	25 l
Diaphragm tank:	Yes
<b>Others:</b>	
Net weight:	507 kg
Gross weight:	621 kg
Shipping volume:	3.06 m <sup>3</sup>
Language:	GB
Country of origin:	GB
Custom tariff no.:	84137075

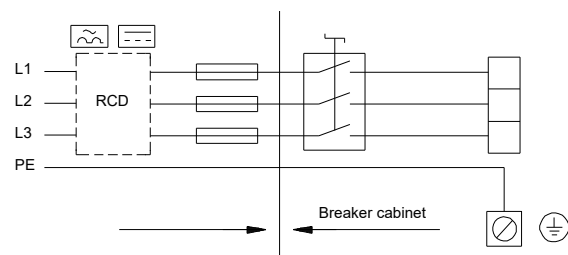
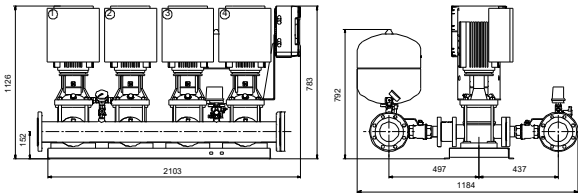
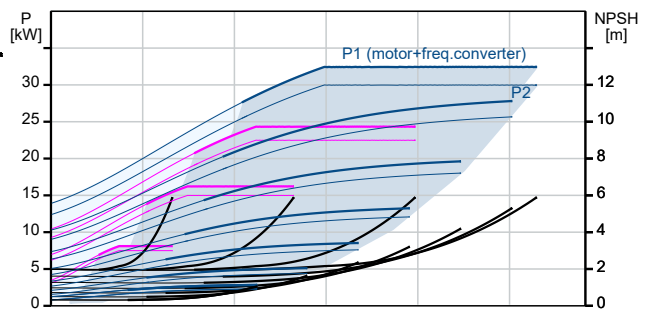
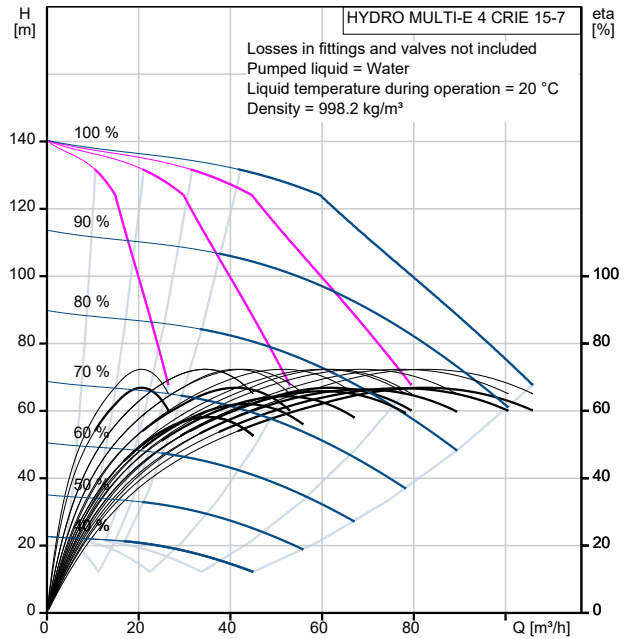

# 99132963 HYDRO MULTI-E 4 CRIE 15-7

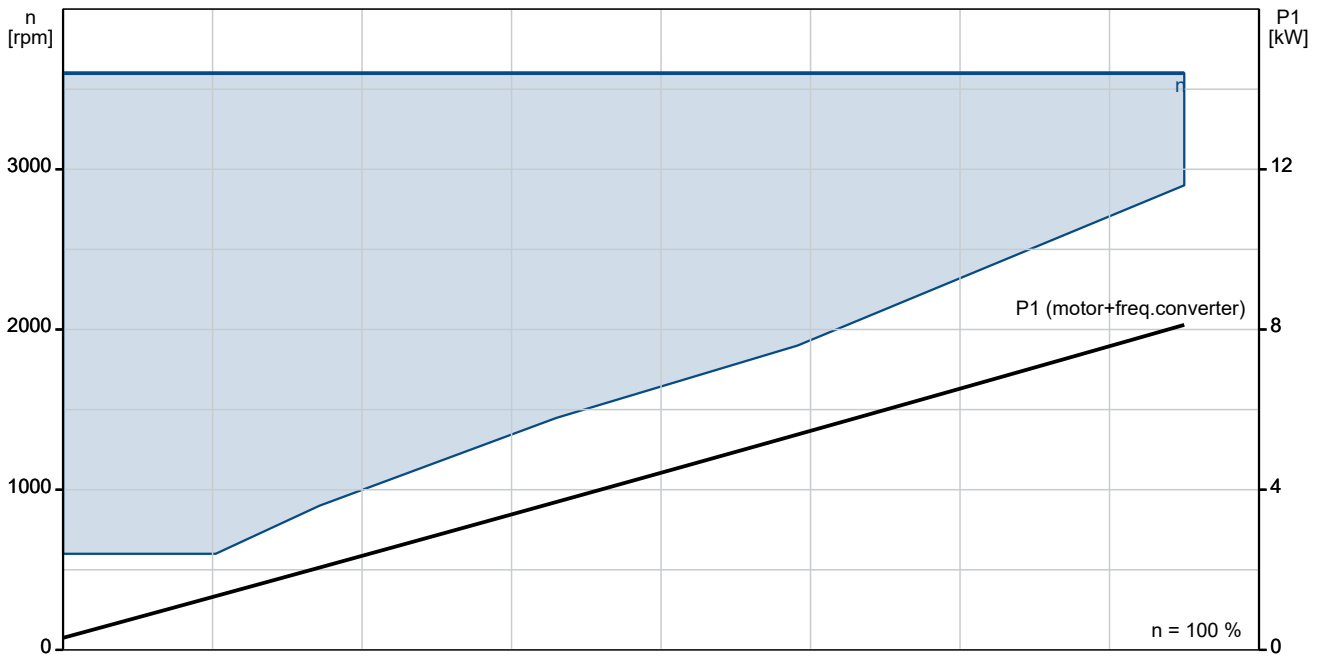
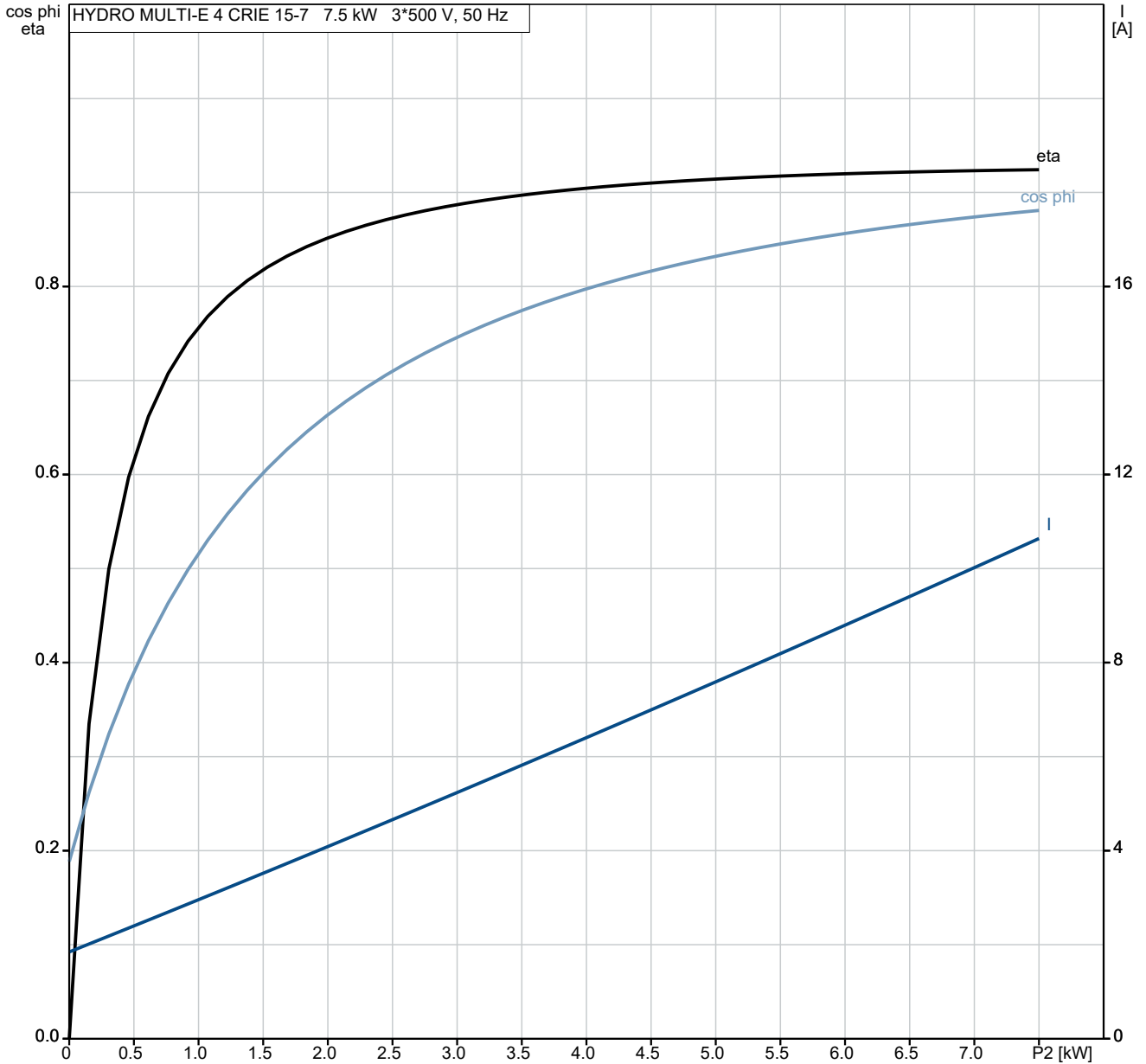

# 99132963 HYDRO MULTI-E 4 CRIE 15-7

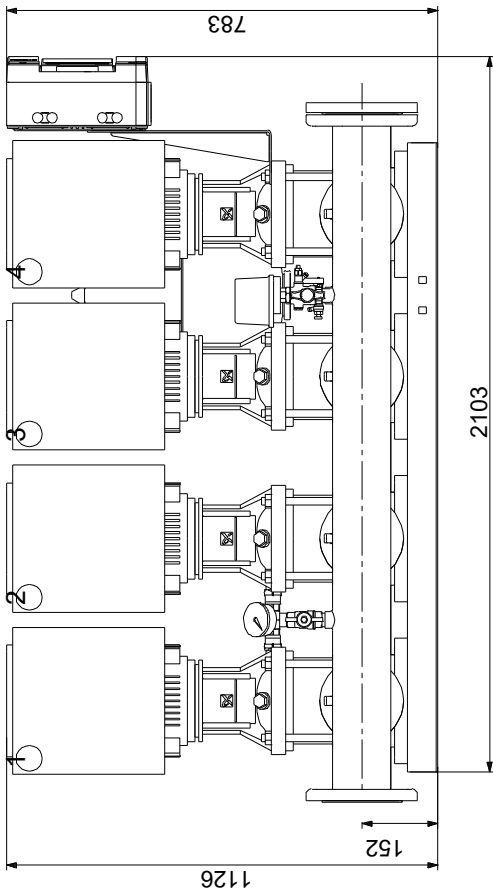
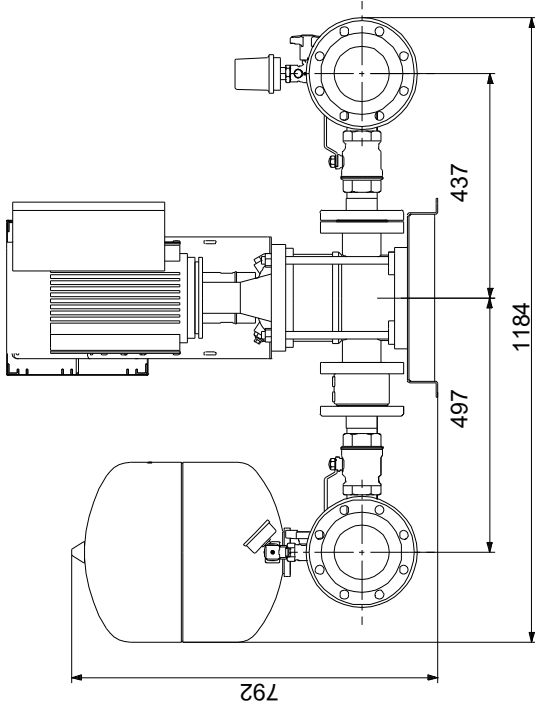

Note! All units are in [mm] unless others are stated.  
Disclaimer: This simplified dimensional drawing does not show all details.

# 99132963 HYDRO MULTI-E 4 CRIE 15-7

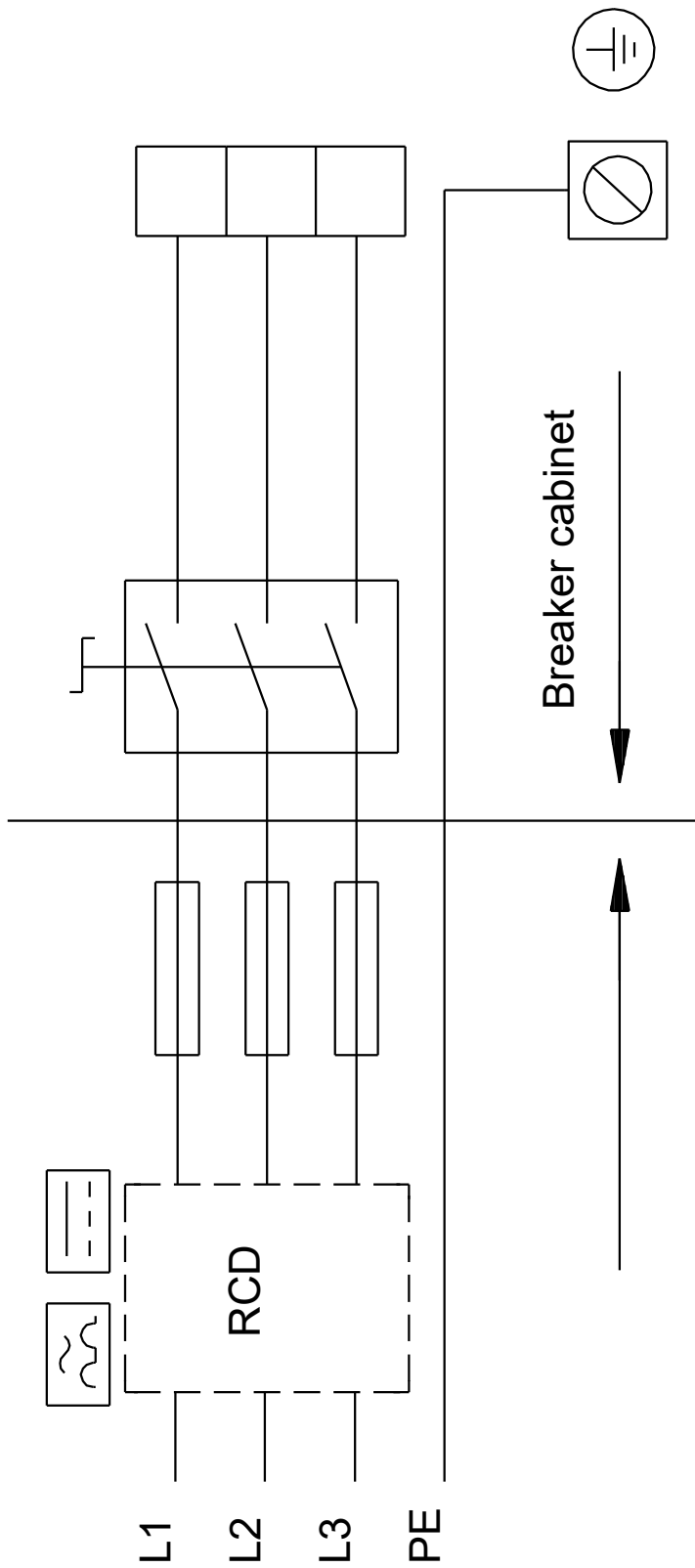

Note! All units are in [mm] unless others are stated.

