

| Qty. | Description  |
|------|--|
| 1    | <p data-bbox="201 159 536 185"><b>HYDRO MULTI-E 2 CRIE 15-7</b></p> <div data-bbox="260 264 520 465" style="text-align: center;">  </div> <p data-bbox="592 506 1062 528" style="text-align: center;"><b>Note! Product picture may differ from actual product</b></p> <p data-bbox="201 539 464 562">Product No.: <a href="#">99132950</a></p> <p data-bbox="201 600 1372 651">GRUNDFOS Hydro Multi-E booster sets are designed for the transfer and pressure boosting of clean water in waterworks, blocks of flats, hotels, industry, hospitals, schools, etc.</p> <p data-bbox="201 658 1453 710">GRUNDFOS Hydro Multi-E booster set consists of 2 to 4 CRIE pumps coupled in parallel and mounted on a common base frame provided with all the necessary fittings.</p> <p data-bbox="201 745 1235 770">Hydro Multi-E is mounted on a common base frame made of stainless steel (DIN W.-Nr. 1.4301).</p> <p data-bbox="201 777 845 801">On the suction side are fitted a suction manifold (DIN W.-Nr.</p> <p data-bbox="201 808 432 833">1.4401 or DIN W.-Nr.</p> <p data-bbox="201 840 1062 864">1.4571) , a pressure switch mounted on a drainable valve and an isolating valve.</p> <p data-bbox="201 871 1437 922">On the discharge side of the pumps are fitted a non-return valve, an isolating valve, a pressure gauge, two pressure transmitters mounted on a drainable valve a diaphragm tank and a stainless steel discharge manifold (DIN W.-Nr.</p> <p data-bbox="201 952 432 976">1.4401 or DIN W.-Nr.</p> <p data-bbox="201 983 293 1008">1.4571).</p> <p data-bbox="201 1014 948 1039">The Hydro Multi-E is fitted with an on/off-switch for the supply voltage.</p> <p data-bbox="201 1068 1374 1093">The Hydro Multi-E is designed for maintaining a constant pressure regardless of flow changes and fluctuation.</p> <p data-bbox="201 1128 1382 1180">The internal PI-controller regulates the number of running pumps and the speed of the pumps according to the required flow.</p> <p data-bbox="201 1216 1433 1240">The system can be operated directly on the panel of any of the pumps or via Grundfos GO (available as accessory)</p> <p data-bbox="201 1301 512 1326">Besides the system features:</p> <ul data-bbox="201 1332 845 1570" style="list-style-type: none"> <li>2 Digital outputs</li> <li>2 Digital inputs (one used for dry run protection)</li> <li>2 Analogue inputs (one used for discharge pressure sensor)</li> <li>Multi-Master functionality</li> <li>2 Limit functions</li> <li>Set-point influence function</li> <li>Pipe filling function</li> <li>High efficient PM motors</li> </ul> <p data-bbox="201 1599 584 1624">Available communication protocols:</p> <ul data-bbox="201 1630 400 1899" style="list-style-type: none"> <li>•LON</li> <li>•Profibus</li> <li>•Modbus</li> <li>•SMS/GSM/GPRS</li> <li>•GRM</li> <li>•BACnet</li> <li>•BACnet IP</li> <li>•Modbus TCP</li> <li>•PROFINET</li> </ul> <p data-bbox="201 1935 1278 1960">When delivered, the GRUNDFOS Hydro Multi-E booster set is factory tested and ready for operation.</p> <p data-bbox="201 2024 632 2076">Liquid:<br/>Pumped liquid:                      Water</p> |

| Qty. | Description  |
|------|--|
| 1    | <p>Liquid temperature range: 5 .. 60 °C<br/> Selected liquid temperature: 20 °C<br/> Density: 998.2 kg/m<sup>3</sup></p> <p>Technical:<br/> Max flow: 60 m<sup>3</sup>/h</p> <p>Materials:<br/> Pump housing: Stainless steel</p> <p>Installation:<br/> Maximum operating pressure: 16 bar<br/> Maximum permissible inlet pressure: PN 16 bar<br/> Flange standard: DIN2642<br/> Manifold inlet: DN 80<br/> Manifold outlet: DN 80</p> <p>Electrical data:<br/> IE Efficiency class: IE5<br/> Power (P2) main pump: 7.5 kW<br/> Mains frequency: 50 / 60 Hz<br/> Rated voltage: 3 x 380-415 V<br/> Rated current: 27 A<br/> Start. method: electronically<br/> Enclosure class (IEC 34-5): IP54</p> <p>Tank:<br/> Volume of pressure tank: 25 l<br/> Diaphragm tank: Yes</p> <p>Others:<br/> Net weight: 271 kg<br/> Gross weight: 328 kg<br/> Shipping volume: 1.65 m<sup>3</sup><br/> Language: GB<br/> Country of origin: GB<br/> Custom tariff no.: 84137075</p> |

# 99132950 HYDRO MULTI-E 2 CRIE 15-7

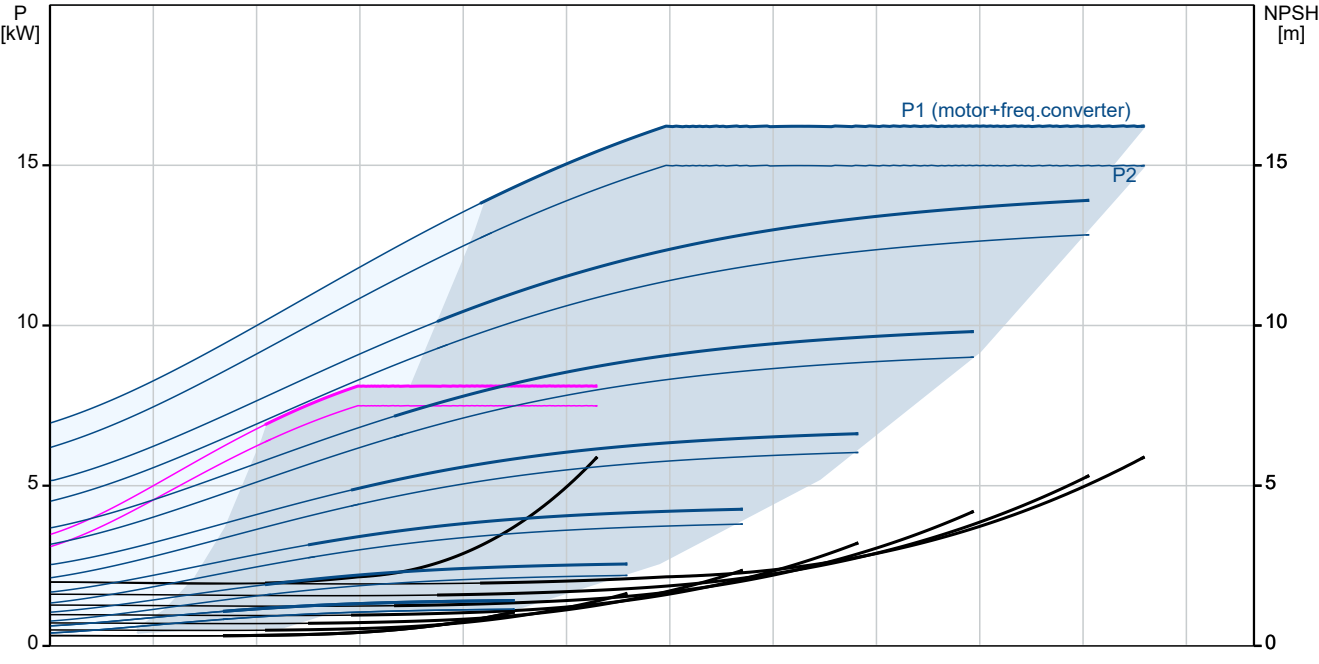
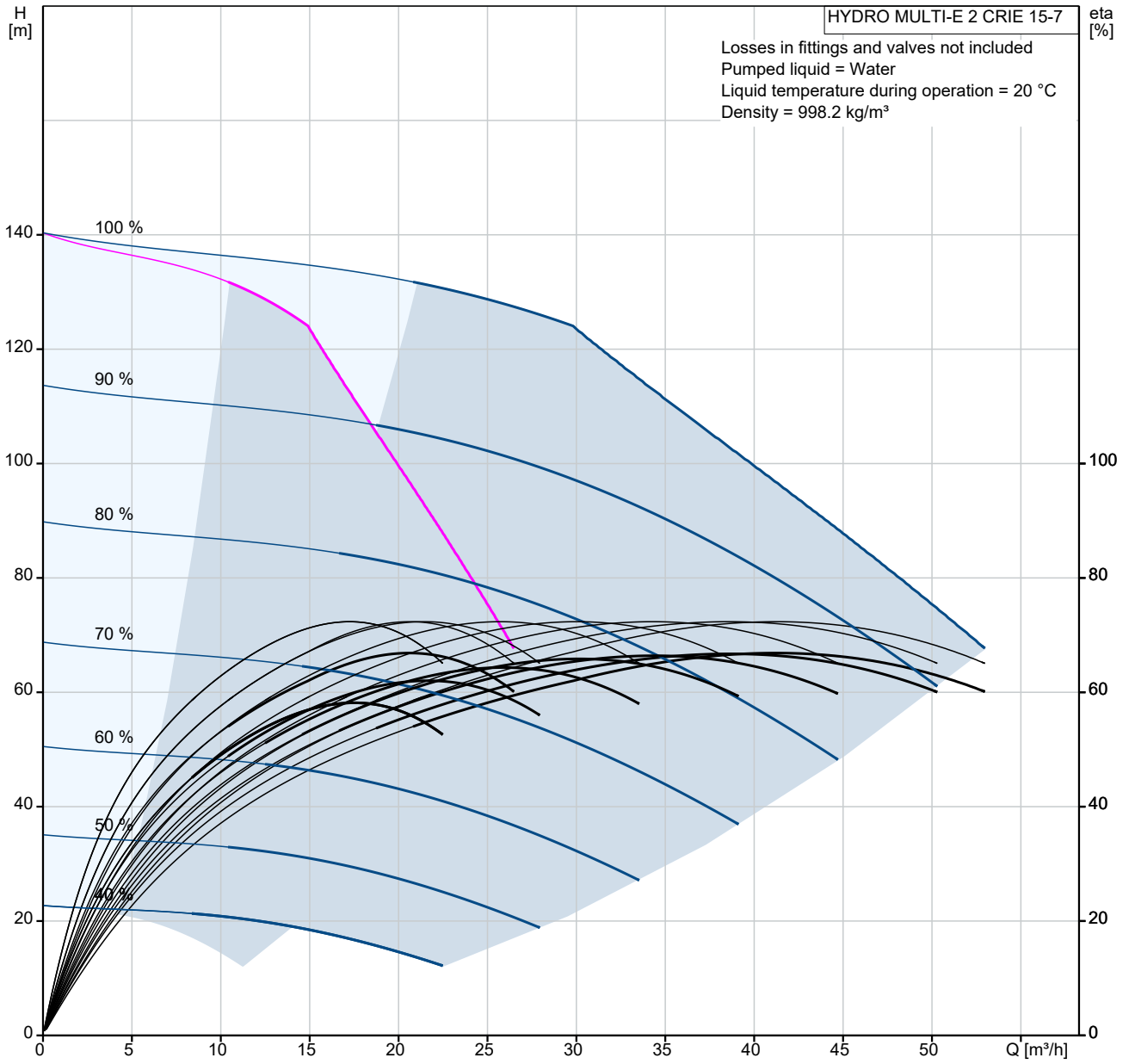

| Description                         | Value                     |
|-------------------------------------|---------------------------|
| <b>General information:</b>         |                           |
| Product name:                       | HYDRO MULTI-E 2 CRIE 15-7 |
| Product No:                         | 99132950                  |
| EAN number:                         | 5712607357177             |
| <b>Technical:</b>                   |                           |
| Max flow:                           | 60 m <sup>3</sup> /h      |
| Min flow system:                    | 6 m <sup>3</sup> /h       |
| Head max:                           | 143 m                     |
| Pump name:                          | CRIE 15-7                 |
| Number of pumps:                    | 2                         |
| <b>Materials:</b>                   |                           |
| Pump housing:                       | Stainless steel           |
| Manifolds:                          | Stainless steel           |
| <b>Installation:</b>                |                           |
| Maximum operating pressure:         | 16 bar                    |
| Maximum permissible inlet pressure: | PN 16 bar                 |
| <b>Liquid:</b>                      |                           |
| Pumped liquid:                      | Water                     |
| Liquid temperature range:           | 5 .. 60 °C                |
| Selected liquid temperature:        | 20 °C                     |
| Density:                            | 998.2 kg/m <sup>3</sup>   |
| <b>Electrical data:</b>             |                           |
| IE Efficiency class:                | IE5                       |
| Power (P2) main pump:               | 7.5 kW                    |
| Mains frequency:                    | 50 / 60 Hz                |
| Rated voltage:                      | 3 x 380-415 V             |
| Rated current:                      | 27 A                      |
| Start. method:                      | electronically            |
| Enclosure class (IEC 34-5):         | IP54                      |
| <b>Tank:</b>                        |                           |
| Volume of pressure tank:            | 25 l                      |
| Diaphragm tank:                     | Yes                       |
| <b>Others:</b>                      |                           |
| Net weight:                         | 271 kg                    |
| Gross weight:                       | 328 kg                    |
| Shipping volume:                    | 1.65 m <sup>3</sup>       |
| Language:                           | GB                        |
| Country of origin:                  | GB                        |
| Custom tariff no.:                  | 84137075                  |

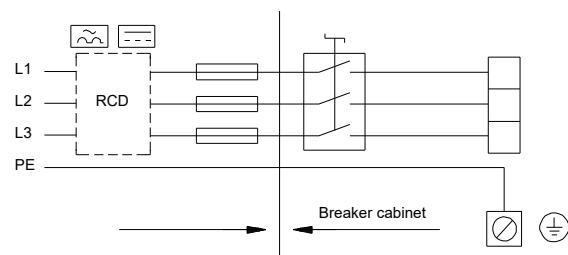
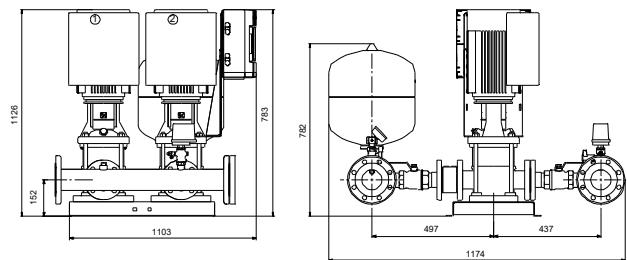
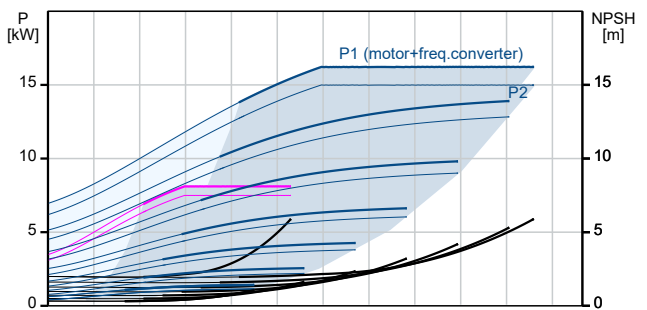
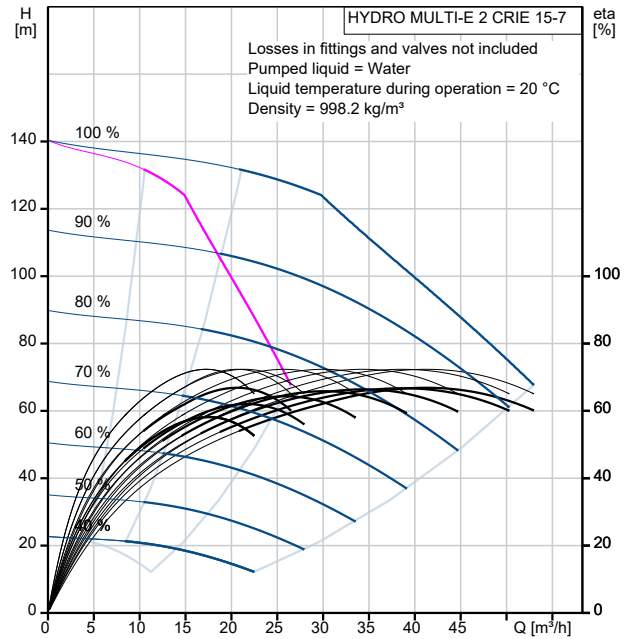

# 99132950 HYDRO MULTI-E 2 CRIE 15-7

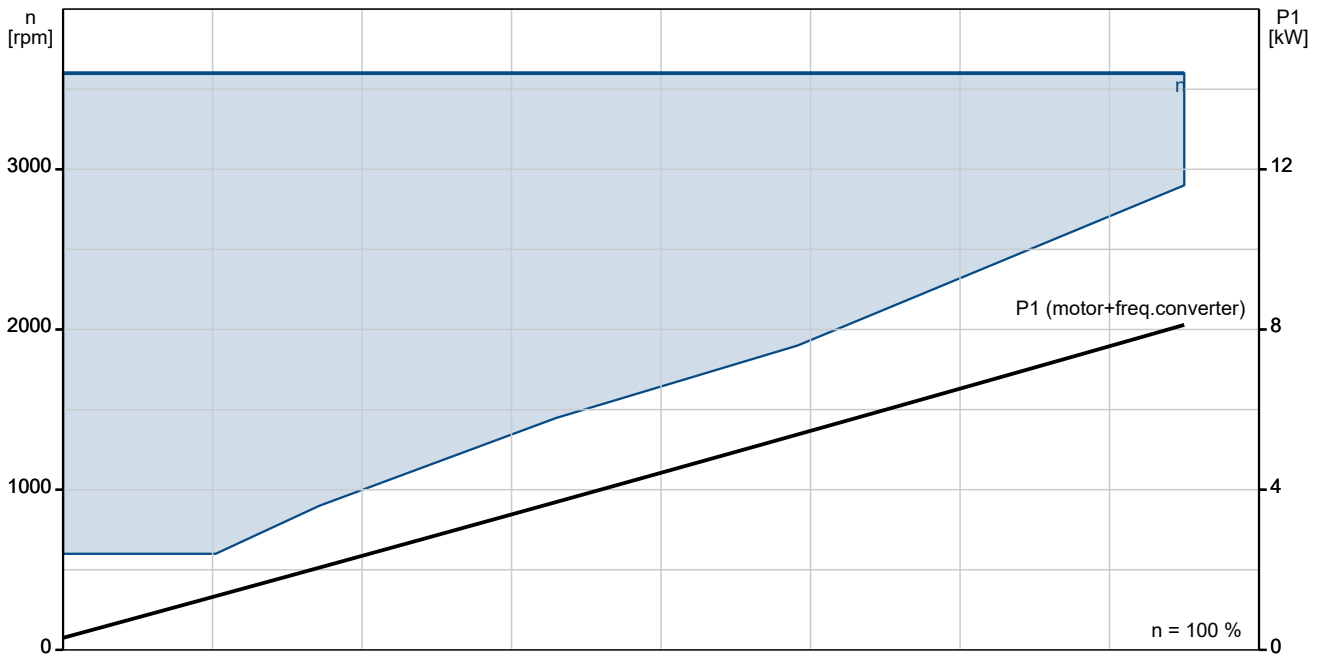
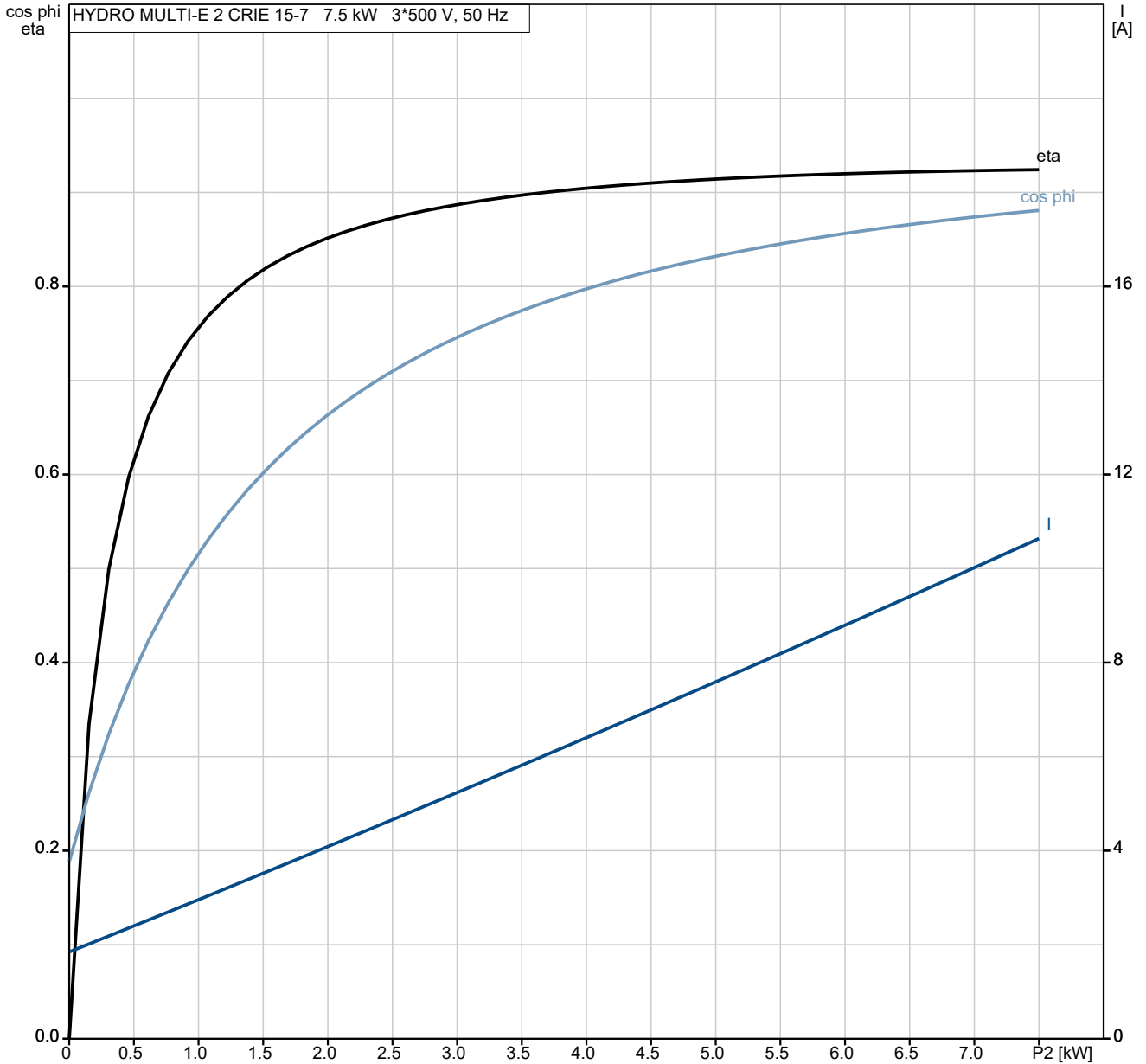

# 99132950 HYDRO MULTI-E 2 CRIE 15-7

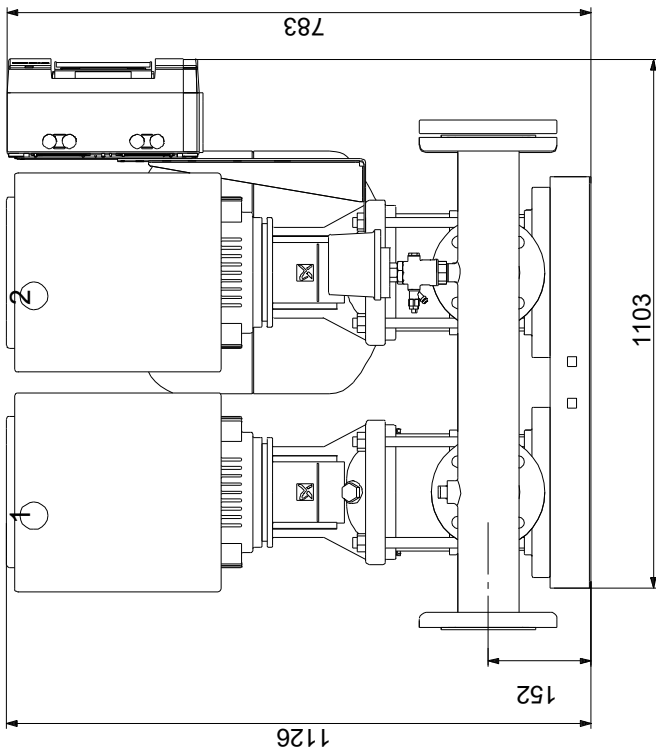
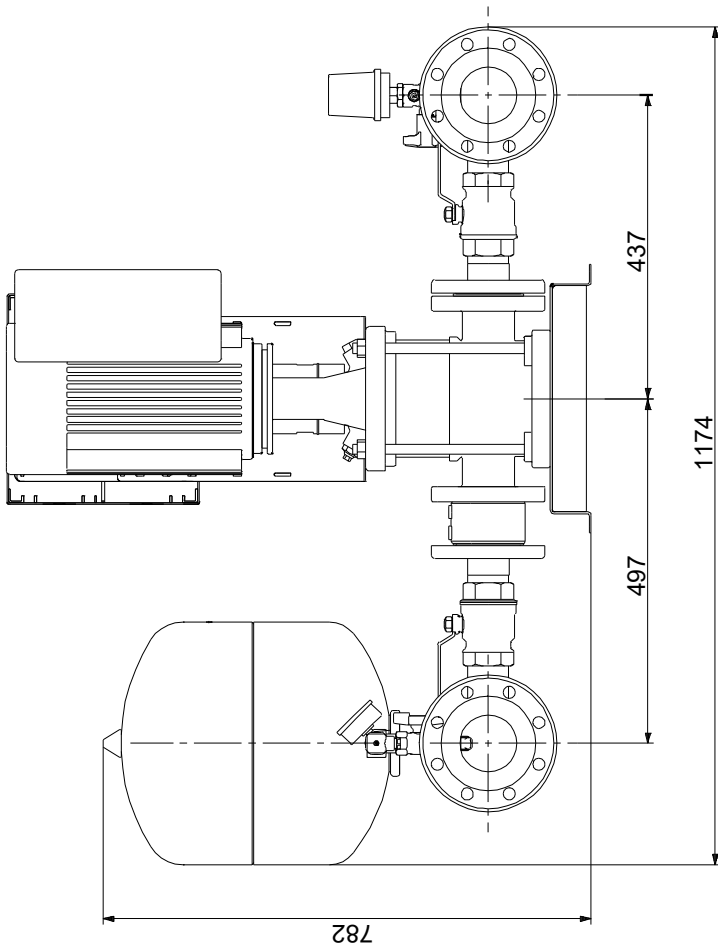

Note! All units are in [mm] unless others are stated.  
Disclaimer: This simplified dimensional drawing does not show all details.

# 99132950 HYDRO MULTI-E 2 CRIE 15-7

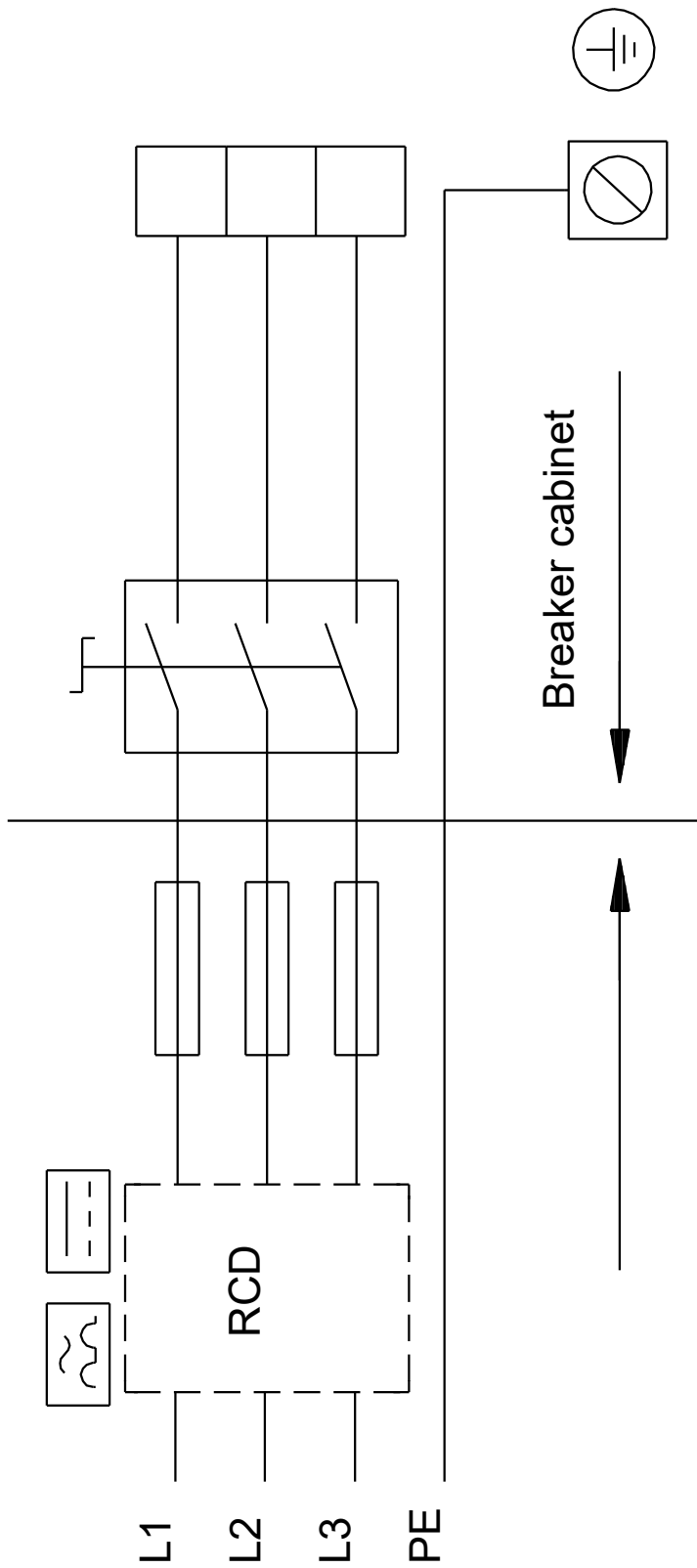

Note! All units are in [mm] unless others are stated.

