

Qty. Description

1 TPED 50-430/2 S-A-F-A-BQQE-LDB



Note! Product picture may differ from actual product

Product No.: On request

Single-stage, close-coupled, volute twin-head pump with in-line suction and discharge ports of identical diameter. The twin-head pump is designed with two parallel power-heads.

The pump is of the top-pull-out design, i.e. the power head (motor, pump head and impeller) can be removed for maintenance or service while the pump housing remains in the pipework.

Each power head is fitted with an unbalanced rubber bellows seal.

The shaft seal is according to EN 12756. Pipework connection is via PN 16 DIN flanges (EN 1092-2 and ISO 7005-2).

Each power head is fitted with a fan-cooled, permanent-magnet synchronous motor of identical size. The motor efficiency is classified as IE5 in accordance with IEC 60034-30-2.

The motor includes a frequency converter and PI controller in the motor terminal box. This enables continuously variable control of the motor speed, which again enables adaptation of the performance to a given requirement.

The pump is fitted with a differential pressure sensor.

The pump is suitable for applications requiring pressure control. The pump is fitted with a differential-pressure transmitter registering the differential pressure across the pump and enabling constant pressure or proportional-pressure control of the pump.

A cable ensures communication between the two power heads. The selector switch in the terminal boxes enables changeover between the operating modes "alternating operation" and "standby operation".

The product's minimum efficiency index (MEI) is greater or equal to 0.70. This is by the Commission Regulation (EU) considered as an indicative benchmark for best-performing water pump available on the market as from 1 January 2013.

A control panel enables setting of required setpoint as well as setting of pump to "Min." or "Max." operation or to "Stop".

The control panel has indicator lights for "Operation" and "Fault".

Communication with the pump is possible by means of the Grundfos GO Remote (accessory).

The remote control enables further settings as well as reading out of a number of parameters such as "Actual value", "Speed", "Power input" and total "Power consumption".

Cast-iron parts have an epoxy-based coating made in a cathodic electro-deposition (CED) process. CED is a high-quality dip-painting process where an electrical field around the products ensures deposition of paint particles as a thin, well-controlled layer on the surface.

Pump

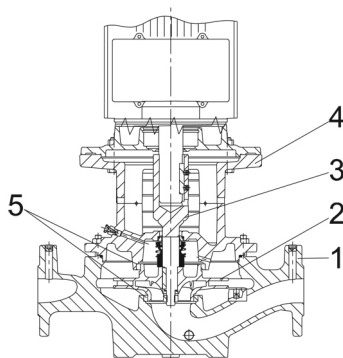

Qty.	Description
	<p>1: Pump housing 2: Impeller 3: Stub shaft 4: Pump head/motor stool 5: Wear rings</p> <p>The twin-head pump is designed with two parallel power-heads. A non-return flap valve in the common discharge port is opened by the flow of the pumped liquid and prevents backflow of liquid into the idle pump head.</p> <p>The pump housing is provided with a replaceable brass neck ring to reduce the amount of liquid running from the outlet side of the impeller to the inlet side.</p> <p>The impeller is secured to the shaft with a nut.</p> <p>The pump is fitted with an unbalanced rubber bellows seal with torque transmission across the spring and around the bellows. Due to the bellows, the seal does not wear the shaft, and the axial movement is not prevented by deposits on the shaft.</p> <p>Seal faces:</p> <ul style="list-style-type: none"> • Rotating seal ring material: silicon carbide (SiC) • Stationary seat material: silicon carbide (SiC) <p>This material pairing is used where higher corrosion resistance is required. The high hardness of this material pairing offers good resistance against abrasive particles.</p> <p>Secondary seal material: EPDM (ethylene-propylene rubber) EPDM has excellent resistance to hot water. EPDM is not suitable for mineral oils.</p> <p>A circulation of liquid through the duct of the air vent screw ensures lubrication and cooling of the shaft seal.</p> <p>The pump housing has four Rp 1/8 tapings for mounting of automatic air vents. Fit an air vent to the upper pump housing if the twin-head pump is to be installed in a horizontal pipeline with horizontal pump shaft.</p> <div data-bbox="199 1019 614 1243" data-label="Image"> </div> <p>The flanges have tapings for mounting of pressure gauges.</p> <p>The motor stool forms connection between the pump housing and the motor, and is equipped with a manual air vent screw for venting of the pump housing and the shaft seal chamber. The sealing between motor stool and pump housing is an O-ring.</p> <p>The central part of the motor stool is provided with guards for protection against the shaft and coupling. The pump shaft is fastened directly on the motor shaft with key and set screws.</p> <p>Motor</p> <p>The motor is a totally enclosed, fan-cooled motor with principal dimensions to IEC and DIN standards. Electrical tolerances comply with IEC 60034.</p> <p>The motor is flange-mounted with free-hole flange (FF). Motor-mounting designation in accordance with IEC 60034-7: IM B 5, IM V 1 (Code I) / IM 3001, IM 3011 (Code II).</p> <p>The motor efficiency is classified as IE5 in accordance with IEC 60034-30-2.</p> <p>The motor requires no external motor protection. The motor control unit incorporates protection against slow- and quick-rising temperatures, e.g. constant overload and stalled conditions.</p> <p>The terminal box holds terminals for these connections:</p> <ul style="list-style-type: none"> • one dedicated digital input • two analog inputs, 0(4)-20 mA, 0-5 V, 0-10 V, 0.5 - 3.5 V; the factory-fitted pressure sensor is connected to one of these inputs • 5 V voltage supply to potentiometer and sensor • one configurable digital input or open-collector output • Grundfos Digital Sensor input and output • 24 V voltage supply for sensors • two signal relay outputs (potential-free contacts) • the two power heads communicate via wireless GENIair or wired GENI connection • interface for Grundfos CIM fieldbus module.

Qty.	Description
	<p>Further product details</p> <p>Cast-iron parts have an epoxy-based coating made in a cathodic electro-deposition (CED) process. CED is a high-quality dip-painting process where an electrical field around the products ensures deposition of paint particles as a thin, well-controlled layer on the surface.</p> <p>Technical data</p> <p>Controls:</p> <p>Frequency converter: Built-in</p> <p>Liquid:</p> <p>Pumped liquid: Water</p> <p>Liquid temperature range: -25 .. 120 °C</p> <p>Selected liquid temperature: 20 °C</p> <p>Density: 998.2 kg/m³</p> <p>Technical:</p> <p>Pump speed on which pump data are based: 2920 rpm</p> <p>Rated flow: 32.7 m³/h</p> <p>Rated head: 29.6 m</p> <p>Actual impeller diameter: 177 mm</p> <p>Code for shaft seal: BQQE</p> <p>Curve tolerance: ISO9906:2012 3B2</p> <p>Materials:</p> <p>Pump housing: Cast iron EN-GJL-250 ASTM class 35</p> <p>Impeller: Cast iron EN-GJL-200 ASTM class 30</p> <p>Installation:</p> <p>Range of ambient temperature: -20 .. 50 °C</p> <p>Maximum operating pressure: 16 bar</p> <p>Max pressure at stated temp: 16 bar / 120 °C</p> <p>Type of connection: DIN</p> <p>Size of connection: DN 50</p> <p>Pressure rating for connection: PN 16</p> <p>Port-to-port length: 340 mm</p> <p>Flange size for motor: FF265</p> <p>Electrical data:</p> <p>Motor type: 132SE</p> <p>IE Efficiency class: IE5</p> <p>Rated power - P2: 5.5 kW</p> <p>Mains frequency: 50 Hz</p> <p>Rated voltage: 3 x 380-500 V</p> <p>Rated current: 10.3-8.20 A</p> <p>Cos phi - power factor: 0.92-0.88</p> <p>Rated speed: 360-4000 rpm</p> <p>Efficiency: 92.7%</p> <p>Motor efficiency at full load: 92.7 %</p> <p>Number of poles: 2</p> <p>Enclosure class (IEC 34-5): IP55</p> <p>Insulation class (IEC 85): F</p> <p>Motor No: 98971271</p>



Company name:

Created by:

Phone:

Date:

16/06/2022

Qty.	Description
------	-------------

	<p>Others: Minimum efficiency index, MEI \geq: 0.70 Net weight: 163 kg Gross weight: 188 kg Shipping volume: 0.65 m³ Country of origin: HU Custom tariff no.: 84137065</p>
--	--

Description	Value
General information:	
Product name:	TPED 50-430/2 S-A-F-A-BQQE-LDB
Product No:	On request
EAN number:	On request
Technical:	
Pump speed on which pump data are based:	2920 rpm
Rated flow:	32.7 m ³ /h
Rated head:	29.6 m
Maximum head:	430 dm
Actual impeller diameter:	177 mm
Code for shaft seal:	BQQE
Curve tolerance:	ISO9906:2012 3B2
Pump version:	A
Materials:	
Pump housing:	Cast iron
Pump housing:	EN-GJL-250
Pump housing:	ASTM class 35
Impeller:	Cast iron
Impeller:	EN-GJL-200
Impeller:	ASTM class 30
Material code:	A
Installation:	
Range of ambient temperature:	-20 .. 50 °C
Maximum operating pressure:	16 bar
Max pressure at stated temp:	16 bar / 120 °C
Type of connection:	DIN
Size of connection:	DN 50
Pressure rating for connection:	PN 16
Port-to-port length:	340 mm
Flange size for motor:	FF265
Connect code:	F
Liquid:	
Pumped liquid:	Water
Liquid temperature range:	-25 .. 120 °C
Selected liquid temperature:	20 °C
Density:	998.2 kg/m ³
Electrical data:	
Motor type:	132SE
IE Efficiency class:	IE5
Rated power - P2:	5.5 kW
Mains frequency:	50 Hz
Rated voltage:	3 x 380-500 V
Rated current:	10.3-8.20 A
Cos phi - power factor:	0.92-0.88
Rated speed:	360-4000 rpm
Efficiency:	92.7%
Motor efficiency at full load:	92.7%
Number of poles:	2
Enclosure class (IEC 34-5):	IP55
Insulation class (IEC 85):	F
Built-in motor protection:	ELEC
Motor No:	98971271
Controls:	
Control panel:	HMI300 - Advanced
Function Module:	FM300 - Advanced
Frequency converter:	Built-in
Others:	

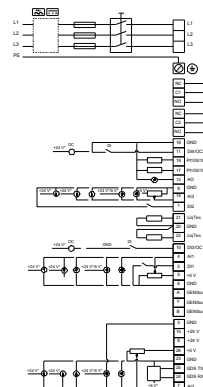
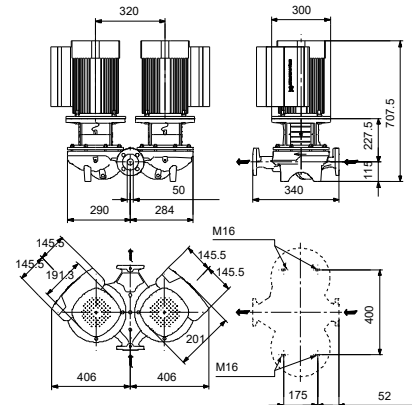
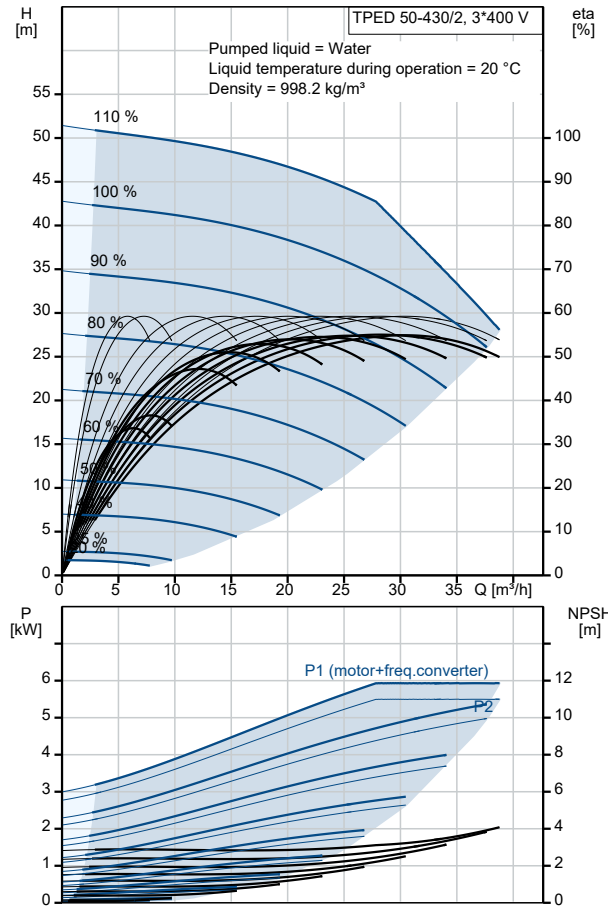



Company name:

Created by:

Phone:

Date:

16/06/2022

Description	Value
Minimum efficiency index, MEI ≥:	0.70
Net weight:	163 kg
Gross weight:	188 kg
Shipping volume:	0.65 m ³
Config. file no:	99247885
Country of origin:	HU
Custom tariff no.:	84137065

On request TPED 50-430/2 S-A-F-A-BQQE-LDB 50 Hz

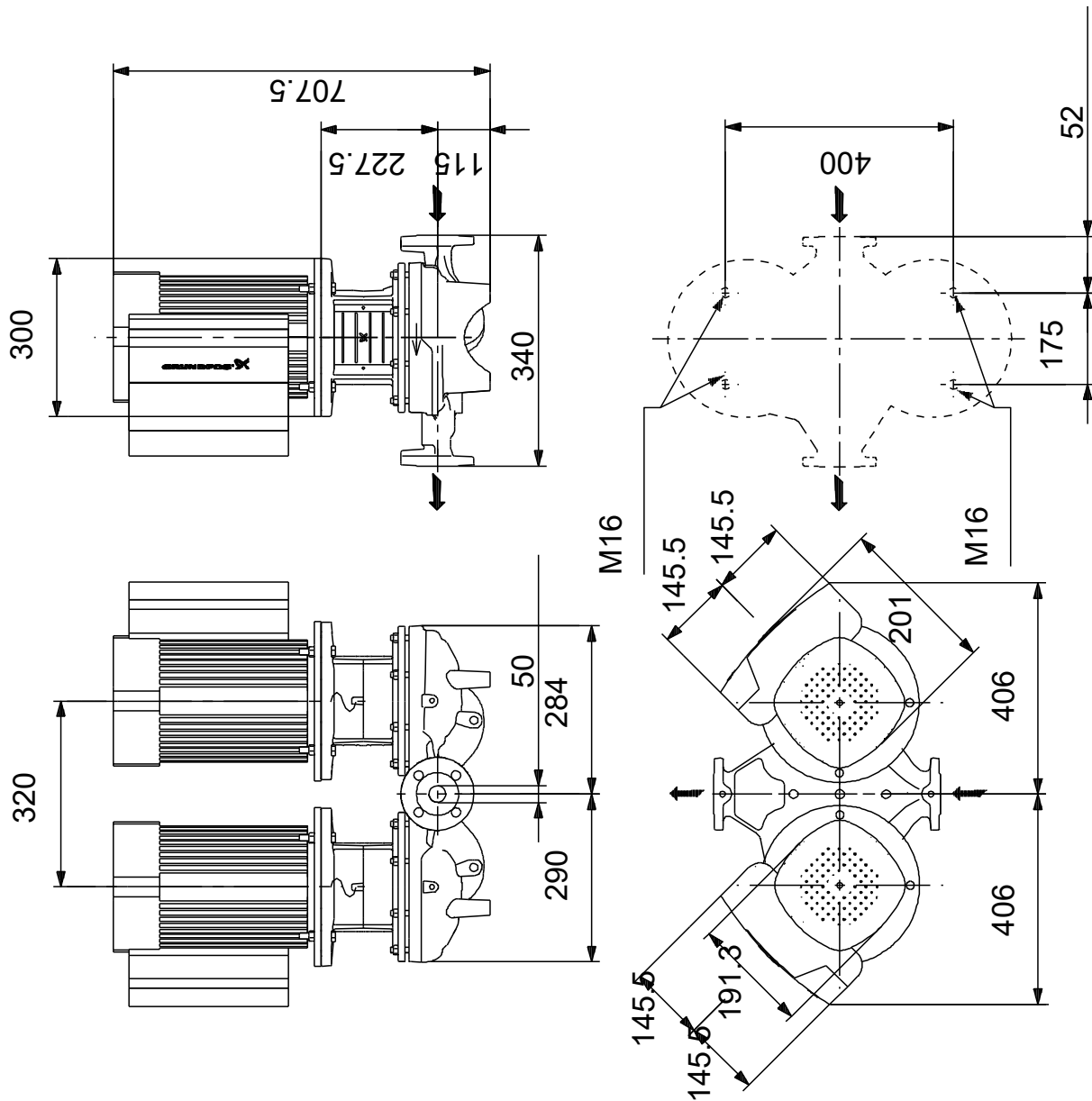

Note! All units are in [mm] unless others are stated.
Disclaimer: This simplified dimensional drawing does not show all details.



Company name:

Created by:

Phone:

Date:

16/06/2022

Order Data:

Product name: TPED 50-430/2

Amount: 1

Product No: On request

Total: Price on request
