

Qty. Description

1 TPE 65-210/2 A-F-A-BQQE-JDB



Note! Product picture may differ from actual product

Product No.: On request

Single-stage, close-coupled, volute pump with in-line suction and discharge ports of identical diameter.

The pump is of the top-pull-out design, i.e. the power head (motor, pump head and impeller) can be removed for maintenance or service while the pump housing remains in the pipework.

The pump is fitted with an unbalanced rubber bellows seal.

The shaft seal is according to EN 12756. Pipework connection is via PN 16 DIN flanges (EN 1092-2 and ISO 7005-2).

The pump is fitted with a fan-cooled, permanent-magnet synchronous motor. The motor efficiency is classified as IE5 in accordance with IEC 60034-30-2.

The product's minimum efficiency index (MEI) is greater or equal to 0.70. This is by the Commission Regulation (EU) considered as an indicative benchmark for best-performing water pump available on the market as from 1 January 2013.

An operating panel on the motor terminal box enables setting of required setpoint as well as setting of pump to "Min." or "Max." operation or to "Stop". The Grundfos Eye indicator on the operating panel provides visual indication of pump status:

- "Power on": Motor is running (rotating green indicator lights) or not running (permanently green indicator lights)
- "Warning": Motor is still running (rotating yellow indicator lights) or has stopped (permanently yellow indicator lights)
- "Alarm": Motor has stopped (flashing red indicator lights).

Communication with the pump is possible by means of Grundfos GO Remote (accessory). The remote control enables further settings as well as reading out of a number of parameters such as "Actual value", "Speed", "Power input" and total "Power consumption".

Cast-iron parts have an epoxy-based coating made in a cathodic electro-deposition (CED) process. CED is a high-quality dip-painting process where an electrical field around the products ensures deposition of paint particles as a thin, well-controlled layer on the surface.

Pump

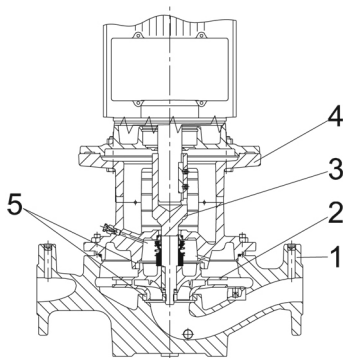

- 1: Pump housing
- 2: Impeller
- 3: Stub shaft
- 4: Pump head/motor stool

Qty.	Description
	<p>5: Wear rings</p> <p>The pump housing is provided with a replaceable brass neck ring to reduce the amount of liquid running from the outlet side of the impeller to the inlet side.</p> <p>The impeller is secured to the shaft with a nut.</p> <p>The pump is fitted with an unbalanced rubber bellows seal with torque transmission across the spring and around the bellows. Due to the bellows, the seal does not wear the shaft, and the axial movement is not prevented by deposits on the shaft.</p> <p>Seal faces:</p> <ul style="list-style-type: none"> • Rotating seal ring material: silicon carbide (SiC) • Stationary seat material: silicon carbide (SiC) <p>This material pairing is used where higher corrosion resistance is required. The high hardness of this material pairing offers good resistance against abrasive particles.</p> <p>Secondary seal material: EPDM (ethylene-propylene rubber)</p> <p>EPDM has excellent resistance to hot water. EPDM is not suitable for mineral oils.</p> <p>A circulation of liquid through the duct of the air vent screw ensures lubrication and cooling of the shaft seal.</p> <p>The flanges have tapings for mounting of pressure gauges.</p> <p>The motor stool forms connection between the pump housing and the motor, and is equipped with a manual air vent screw for venting of the pump housing and the shaft seal chamber. The sealing between motor stool and pump housing is an O-ring.</p> <p>The central part of the motor stool is provided with guards for protection against the shaft and coupling. The pump shaft is fastened directly on the motor shaft with key and set screws.</p> <p>Motor</p> <p>The motor is a totally enclosed, fan-cooled motor with principal dimensions to IEC and DIN standards. Electrical tolerances comply with IEC 60034.</p> <p>The motor efficiency is classified as IE5 in accordance with IEC 60034-30-2.</p> <p>The motor requires no external motor protection. The motor control unit incorporates protection against slow- and quick-rising temperatures, e.g. constant overload and stalled conditions.</p> <p>Further product details</p> <p>Cast-iron parts have an epoxy-based coating made in a cathodic electro-deposition (CED) process. CED is a high-quality dip-painting process where an electrical field around the products ensures deposition of paint particles as a thin, well-controlled layer on the surface.</p> <p>Technical data</p> <p>Controls:</p> <p>Frequency converter: Built-in</p> <p>Liquid:</p> <p>Pumped liquid: Water</p> <p>Liquid temperature range: -25 .. 120 °C</p> <p>Selected liquid temperature: 20 °C</p> <p>Density: 998.2 kg/m³</p> <p>Technical:</p> <p>Pump speed on which pump data are based: 2910 rpm</p> <p>Rated flow: 46.3 m³/h</p> <p>Rated head: 16.8 m</p> <p>Actual impeller diameter: 127 mm</p> <p>Code for shaft seal: BQQE</p> <p>Curve tolerance: ISO9906:2012 3B2</p> <p>Materials:</p> <p>Pump housing: Cast iron EN-GJL-250 ASTM class 35</p> <p>Impeller: Cast iron</p>

Qty.	Description
	<p>EN-GJL-200 ASTM class 30</p> <p>Installation:</p> <p>Range of ambient temperature: -20 .. 50 °C Maximum operating pressure: 16 bar Max pressure at stated temp: 16 bar / 120 °C Type of connection: DIN Size of connection: DN 65 Pressure rating for connection: PN 16 Port-to-port length: 360 mm Flange size for motor: FF215</p> <p>Electrical data:</p> <p>Motor type: 100LA IE Efficiency class: IE5 Rated power - P2: 3 kW Mains frequency: 50 Hz Rated voltage: 3 x 380-500 V Rated current: 5.80-4.80 A Cos phi - power factor: 0.91-0.86 Rated speed: 360-4000 rpm Efficiency: 90.7% Motor efficiency at full load: 90.7 % Number of poles: 2 Enclosure class (IEC 34-5): IP55 Insulation class (IEC 85): F Motor No: 98971186</p> <p>Others:</p> <p>Minimum efficiency index, MEI ≥: 0.70 Net weight: 60.3 kg Gross weight: 79 kg Shipping volume: 0.39 m³ Danish VVS No.: 382064210 Finnish LVI No.: 4616468 Norwegian NRF no.: 9043663 Country of origin: HU Custom tariff no.: 84137051</p>

On request TPE 65-210/2 A-F-A-BQQE-JDB 50 Hz

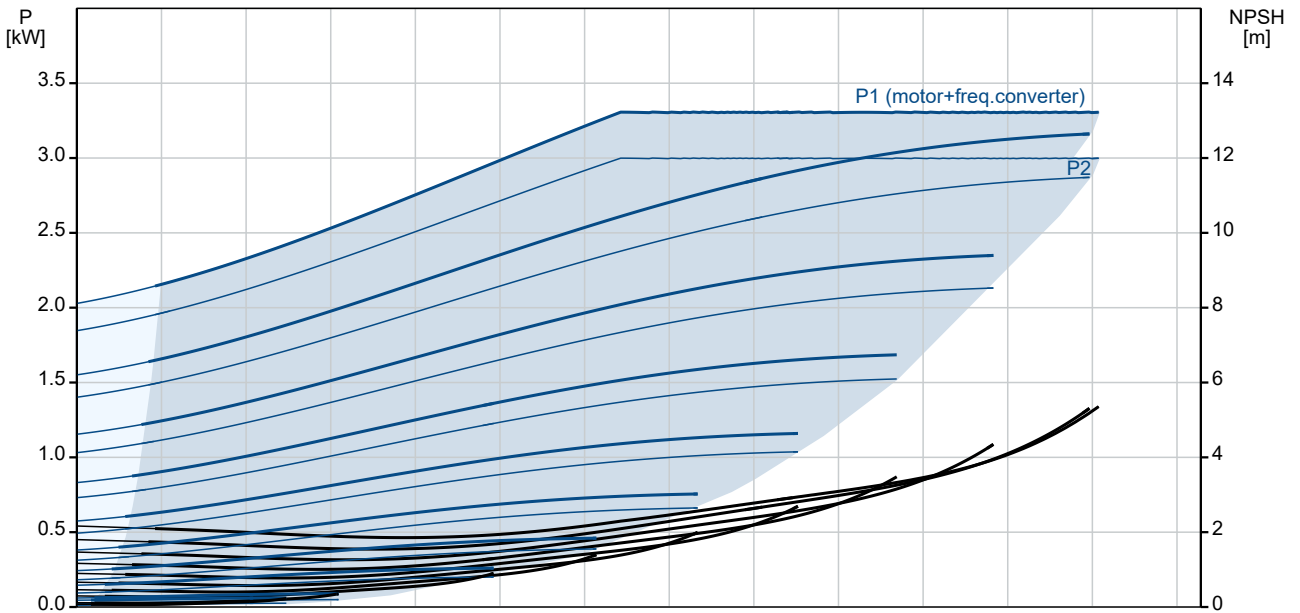
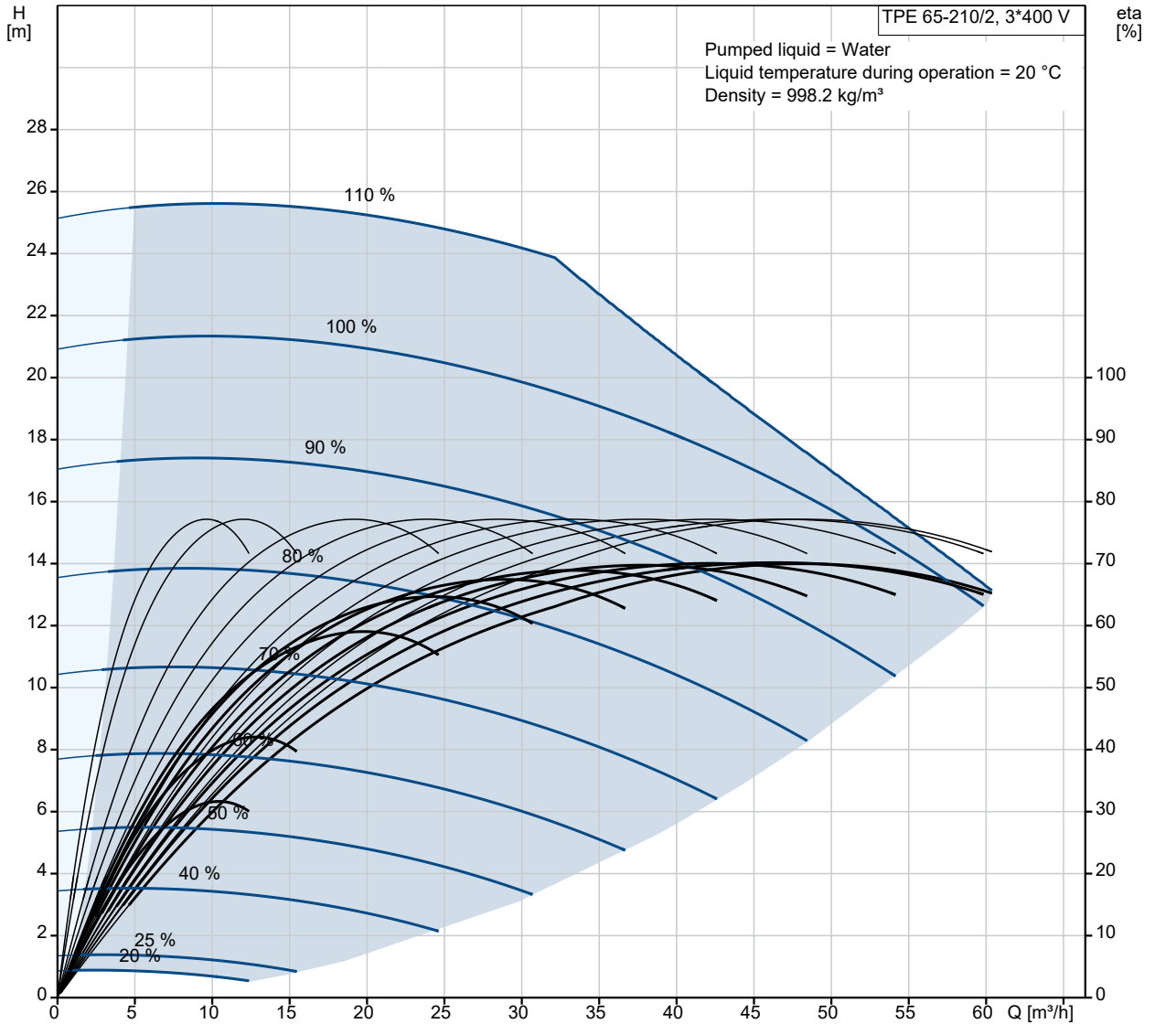

Description	Value
General information:	
Product name:	TPE 65-210/2 A-F-A-BQQE-JDB
Product No:	On request
EAN number:	On request
Technical:	
Pump speed on which pump data are based:	2910 rpm
Rated flow:	46.3 m ³ /h
Rated head:	16.8 m
Maximum head:	210 dm
Actual impeller diameter:	127 mm
Code for shaft seal:	BQQE
Curve tolerance:	ISO9906:2012 3B2
Pump version:	A
Materials:	
Pump housing:	Cast iron
Pump housing:	EN-GJL-250
Pump housing:	ASTM class 35
Impeller:	Cast iron
Impeller:	EN-GJL-200
Impeller:	ASTM class 30
Material code:	A
Installation:	
Range of ambient temperature:	-20 .. 50 °C
Maximum operating pressure:	16 bar
Max pressure at stated temp:	16 bar / 120 °C
Type of connection:	DIN
Size of connection:	DN 65
Pressure rating for connection:	PN 16
Port-to-port length:	360 mm
Flange size for motor:	FF215
Connect code:	F
Liquid:	
Pumped liquid:	Water
Liquid temperature range:	-25 .. 120 °C
Selected liquid temperature:	20 °C
Density:	998.2 kg/m ³
Electrical data:	
Motor type:	100LA
IE Efficiency class:	IE5
Rated power - P2:	3 kW
Mains frequency:	50 Hz
Rated voltage:	3 x 380-500 V
Rated current:	5.80-4.80 A
Cos phi - power factor:	0.91-0.86
Rated speed:	360-4000 rpm
Efficiency:	90.7%
Motor efficiency at full load:	90.7 %
Number of poles:	2
Enclosure class (IEC 34-5):	IP55
Insulation class (IEC 85):	F
Built-in motor protection:	ELEC
Motor No:	98971186
Controls:	
Control panel:	HMI200 - Standard
Function Module:	FM300 - Advanced
Frequency converter:	Built-in
Others:	

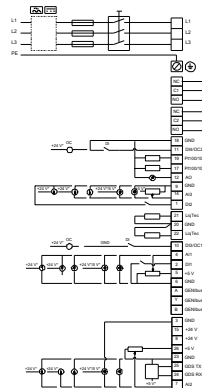
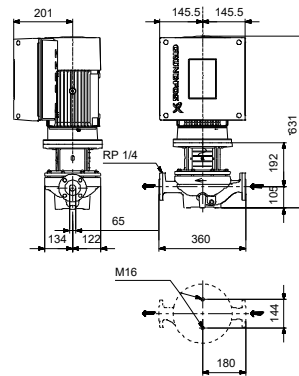
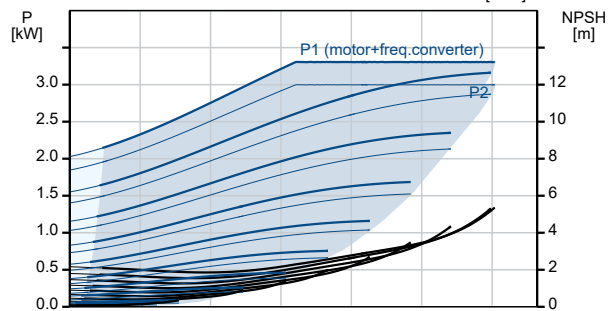
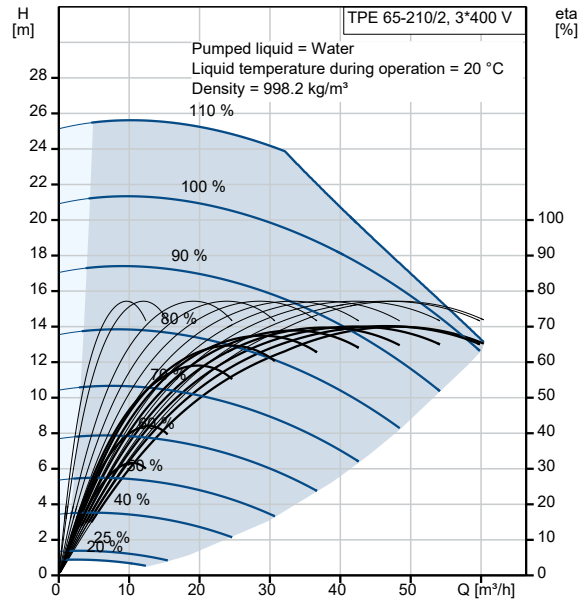



Company name:

Created by:

Phone:

Date:

16/06/2022

Description	Value
Minimum efficiency index, MEI ≥:	0.70
Net weight:	60.3 kg
Gross weight:	79 kg
Shipping volume:	0.39 m ³
Config. file no:	99100549
Danish VVS No.:	382064210
Finnish LVI No.:	4616468
Norwegian NRF no.:	9043663
Country of origin:	HU
Custom tariff no.:	84137051

On request TPE 65-210/2 A-F-A-BQQE-JDB 50 Hz



Note! All units are in [mm] unless others are stated.



Company name:

Created by:

Phone:

Date:

16/06/2022

Order Data:

Product name: TPE 65-210/2

Amount: 1

Product No: On request

Total: Price on request
