

| Qty. | Description |
|------|-------------|
|------|-------------|

| | |
|---|----------------------------------|
| 1 | NKE 32-200.1/188 AA2F2AESBQQEKWB |
|---|----------------------------------|



Note! Product picture may differ from actual product

Product No.: On request

Non-self-priming, single-stage, centrifugal pump designed according to ISO 5199 with dimensions and rated performance according to EN 733. Flanges are PN 16 with dimensions according to EN 1092-2. The pump has an axial suction port, a radial discharge port and horizontal shaft. It is of the back pull-out design enabling removal of the coupling, bearing bracket and impeller without disturbing the motor, pump housing or pipework.

The unbalanced rubber bellows seal is according to DIN EN 12756.

The pump is fitted with a foot-mounted, fan-cooled, permanent-magnet synchronous motor. Pump and motor are mounted on a common base frame.

The motor includes a frequency converter and PI controller in the motor terminal box. This enables continuously variable control of the motor speed, which again enables adaptation of the performance to a given requirement.

An external sensor can be connected if controlled pump operation is required for flow, differential pressure or temperature control.

The operating panel on the motor terminal box features a four-inch TFT display, push-buttons and the Grundfos Eye indicator.

The display gives an intuitive and user-friendly interface to all functions.

The push-buttons are used to navigate through the menu structure to access pump and performance data on site and enable setting of required setpoint as well as setting of pump to "Min." or "Max." operation or to "Stop".

The Grundfos Eye indicator on the operating panel provides visual indication of pump status:

- "Power on": Motor is running (rotating green indicator lights) or not running (permanently green indicator lights)
- "Warning": Motor is still running (rotating yellow indicator lights) or has stopped (permanently yellow indicator lights)
- "Alarm": Motor has stopped (flashing red indicator lights).

Communication with the pump is also possible by means of Grundfos GO Remote (accessory). The remote control enables further settings as well as reading out of a number of parameters such as "Actual value", "Speed", "Power input" and total "Power consumption".

Pump and motor are mounted on a common steel base frame in accordance with ISO 3661.

The back pull-out design together with a spacer coupling makes it possible to service the pump without dismantling the pump housing and motor from the base frame.

This saves realignment of pump and motor after service.

- 1) Remove coupling.
- 2) Remove the bolts in the bearing bracket support foot.
- 3) Remove the bearing bracket from the pump housing.

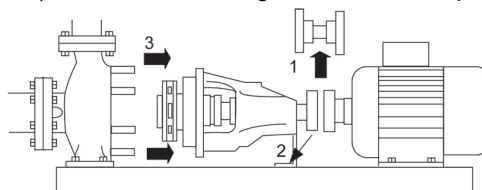

Pump

The pump housing has both a priming and a drain hole closed by plugs. The impeller is a closed impeller with double-curved blades with smooth surfaces. The impeller is statically balanced according to ISO 1940-1 class G6.3 and hydraulically balanced to compensate for axial thrust.

Wear rings used in pump housing and for impeller are made of bronze/brass.

Qty. Description

The pump is fitted with an unbalanced rubber bellows seal with torque transmission across the spring and around the bellows. Due to the bellows, the seal does not wear the shaft, and the axial movement is not prevented by deposits on the shaft.

{IMG Filename: GRALON_NB-NK-G_SHAFTSEAL_Bxxx.gif }

Seal faces:

- Rotating seal ring material: silicon carbide (SiC)
- Stationary seat material: silicon carbide (SiC)

This material pairing is used where higher corrosion resistance is required. The high hardness of this material pairing offers good resistance against abrasive particles.

Secondary seal material: EPDM (ethylene-propylene rubber)

EPDM has excellent resistance to hot water. EPDM is not suitable for mineral oils.

The shaft is made of stainless steel and has a diameter of 24 mm where the coupling is mounted.

The pump uses a spacer coupling between the pump and motor shaft.

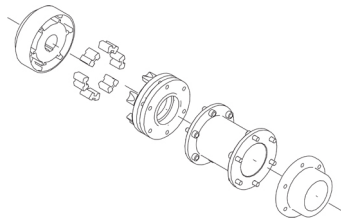

Motor

The motor is a totally enclosed, fan-cooled motor with principal dimensions to IEC and DIN standards. Electrical tolerances comply with IEC 60034.

The motor efficiency is classified as IE5 in accordance with IEC 60034-30-2.

The motor requires no external motor protection. The motor control unit incorporates protection against slow- and quick-rising temperatures, e.g. constant overload and stalled conditions.

The terminal box holds terminals for these connections:

- one dedicated digital input
- two analog inputs, 0(4)-20 mA, 0-5 V, 0-10 V, 0.5 - 3.5 V
- 5 V voltage supply to potentiometer and sensor
- one configurable digital input or open-collector output
- Grundfos Digital Sensor input and output
- 24 V voltage supply for sensors
- two signal-relay outputs (potential-free contacts)
- GENIbus connection
- interface for Grundfos CIM fieldbus module.

Further product details

Cast-iron parts have an epoxy-based coating made in a cathodic electro-deposition (CED) process. CED is a high-quality dip-painting process where an electrical field around the products ensures deposition of paint particles as a thin, well-controlled layer on the surface.

Technical data

Controls:

Frequency converter: Built-in

Pressure sensor: N

Liquid:

Pumped liquid: Water

Liquid temperature range: -25 .. 120 °C

Selected liquid temperature: 20 °C

Density: 998.2 kg/m³

Technical:

| Qty. | Description |
|------|---|
| | <p>Pump speed on which pump data are based: 2901 rpm</p> <p>Rated flow: 20.01 m³/h</p> <p>Pump with motor (Yes/No): Y</p> <p>Rated head: 34.82 m</p> <p>Actual impeller diameter: 188 mm</p> <p>Nominal impeller diameter: 200.1</p> <p>Code for shaft seal: BQQE</p> <p>Mechanical seal type: Single</p> <p>Curve tolerance: ISO9906:2012 3B2</p> <p>Bearing design: Standard</p> <p>Materials:</p> <p>Pump housing: Cast iron EN-GJL-250 ASTM class 35</p> <p>Wear ring: Brass</p> <p>Impeller: Cast iron EN-GJL-200 ASTM class 30</p> <p>Internal pump house coating: CED</p> <p>Shaft: Stainless steel EN 1.4301 AISI 304</p> <p>Installation:</p> <p>Range of ambient temperature: -20 .. 50 °C</p> <p>Maximum operating pressure: 16 bar</p> <p>Pipe connection standard: EN 1092-2</p> <p>Type of inlet connection: DIN</p> <p>Type of outlet connection: DIN</p> <p>Size of inlet connection: DN 50</p> <p>Size of outlet connection: DN 32</p> <p>Pressure rating for connection: PN 16</p> <p>Coupling type: Flexible w/spacer</p> <p>Base frame design: EN/ISO</p> <p>Code for base frame: 4</p> <p>Grouting (Yes/No): N</p> <p>Electrical data:</p> <p>Motor type: 112MC</p> <p>IE Efficiency class: IE5</p> <p>Rated power - P2: 4 kW</p> <p>Mains frequency: 50 Hz</p> <p>Rated voltage: 3 x 380-500 V</p> <p>Rated current: 7.60-6.20 A</p> <p>Cos phi - power factor: 0.92-0.87</p> <p>Rated speed: 360-4000 rpm</p> <p>Efficiency: 92.2%</p> <p>Motor efficiency at full load: 92.2 %</p> <p>Number of poles: 2</p> <p>Enclosure class (IEC 34-5): IP55</p> <p>Insulation class (IEC 85): F</p> <p>Motor No: 99306753</p> <p>Bearing insulation type N-end: STEEL BEARING</p> <p>Others:</p> <p>Minimum efficiency index, MEI ≥: 0.52</p> <p>Net weight: 134 kg</p> <p>Gross weight: 148 kg</p> |



Company name:

Created by:

Phone:

Date:

16/06/2022

| Qty. | Description |
|------|-------------|
|------|-------------|

| | |
|--|---|
| | Shipping volume: 0.317 m ³ Country of origin: HU Custom tariff no.: 84137059 |
|--|---|

On request NKE 32-200.1/188 AA2F2AESBQQEKWB 50 Hz

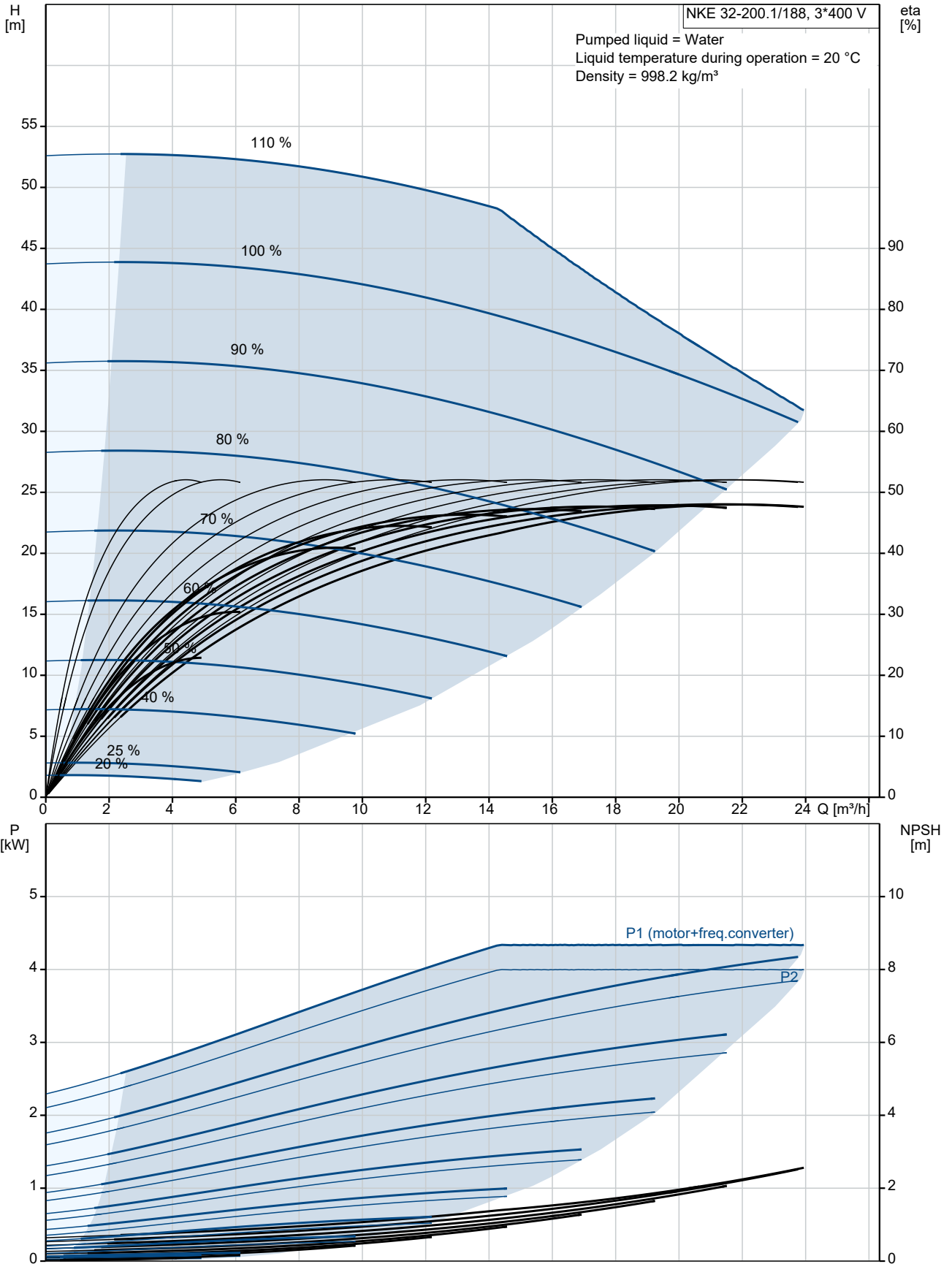

| Description | Value |
|--|-------------------------------------|
| General information: | |
| Product name: | NKE 32-200.1/188 AA2F2AESBQQEKWB |
| Product No: | On request |
| EAN number: | On request |
| Technical: | |
| Pump speed on which pump data are based: | 2901 rpm |
| Rated flow: | 20.01 m ³ /h |
| Pump with motor (Yes/No): | Y |
| Rated head: | 34.82 m |
| Actual impeller diameter: | 188 mm |
| Nominal impeller diameter: | 200.1 |
| Shaft diameter: | 24 mm |
| Code for shaft seal: | BQQE |
| Mechanical seal type: | Single |
| Curve tolerance: | ISO9906:2012 3B2 |
| Pump version: | A2 |
| Bearing design: | Standard |
| Materials: | |
| Pump housing: | Cast iron |
| Pump housing: | EN-GJL-250 |
| Pump housing: | ASTM class 35 |
| Wear ring: | Brass |
| Impeller: | Cast iron |
| Impeller: | EN-GJL-200 |
| Impeller: | ASTM class 30 |
| Internal pump house coating: | CED |
| Material code: | A |
| Code for rubber: | E |
| Shaft: | Stainless steel |
| Shaft: | EN 1.4301 |
| Shaft: | AISI 304 |
| Installation: | |
| Range of ambient temperature: | -20 .. 50 °C |
| Maximum operating pressure: | 16 bar |
| Pipe connection standard: | EN 1092-2 |
| Type of inlet connection: | DIN |
| Type of outlet connection: | DIN |
| Size of inlet connection: | DN 50 |
| Size of outlet connection: | DN 32 |
| Pressure rating for connection: | PN 16 |
| Coupling type: | Flexible w/spacer |
| Base frame design: | EN/ISO |
| Code for base frame: | 4 |
| Grouting (Yes/No): | N |
| Connect code: | F |
| Liquid: | |
| Pumped liquid: | Water |
| Liquid temperature range: | -25 .. 120 °C |
| Selected liquid temperature: | 20 °C |
| Density: | 998.2 kg/m ³ |
| Electrical data: | |
| Motor type: | 112MC |
| IE Efficiency class: | IE5 |
| Rated power - P2: | 4 kW |
| Mains frequency: | 50 Hz |
| Rated voltage: | 3 x 380-500 V |
| Rated current: | 7.60-6.20 A |

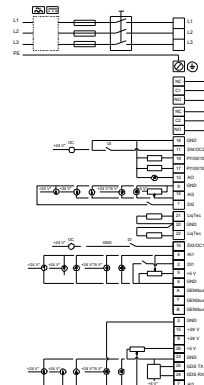
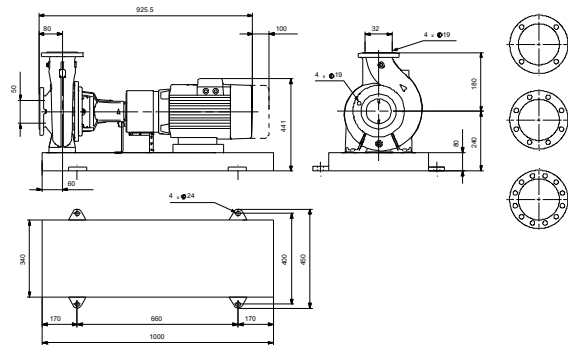
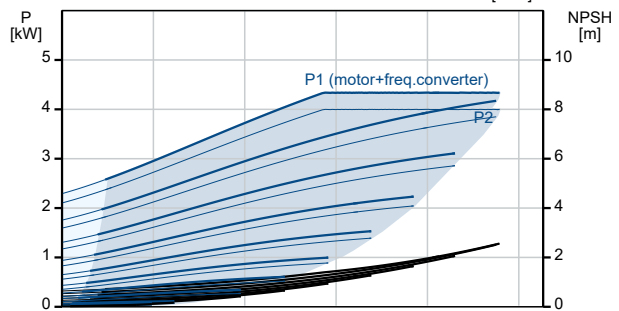
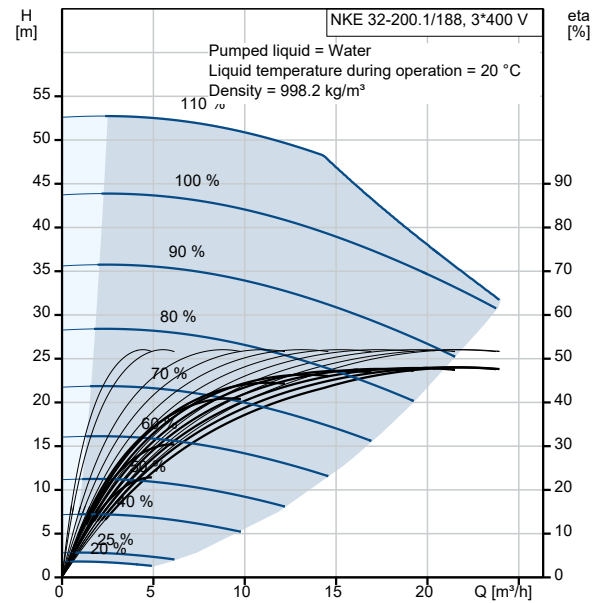



Company name:

Created by:

Phone:

Date:

16/06/2022

| Description | Value |
|--|----------------------|
| Cos phi - power factor: | 0.92-0.87 |
| Rated speed: | 360-4000 rpm |
| Efficiency: | 92.2% |
| Motor efficiency at full load: | 92.2 % |
| Number of poles: | 2 |
| Enclosure class (IEC 34-5): | IP55 |
| Insulation class (IEC 85): | F |
| Built-in motor protection: | ELEC |
| Motor No: | 99306753 |
| Bearing insulation type N-end: | STEEL BEARING |
| Controls: | |
| Control panel: | HMI300 - Advanced |
| Function Module: | FM300 - Advanced |
| Frequency converter: | Built-in |
| Pressure sensor: | N |
| Others: | |
| Minimum efficiency index, MEI \geq : | 0.52 |
| Net weight: | 134 kg |
| Gross weight: | 148 kg |
| Shipping volume: | 0.317 m ³ |
| Country of origin: | HU |
| Custom tariff no.: | 84137059 |

On request NKE 32-200.1/188 AA2F2AESBQQEKWB 50 Hz



Note! All units are in [mm] unless others are stated.



Company name:

Created by:

Phone:

Date:

16/06/2022

Order Data:

Product name: NKE 32-200.1/188

Amount: 1

Product No: On request

Total: Price on request
