

**Qty. Description**

1 NKE 65-200/205 AA2F2AESBQQEJWA



**Note! Product picture may differ from actual product**

Product No.: On request

Non-self-priming, single-stage, centrifugal pump designed according to ISO 5199 with dimensions and rated performance according to EN 733. Flanges are PN 16 with dimensions according to EN 1092-2. The pump has an axial suction port, a radial discharge port and horizontal shaft. It is of the back pull-out design enabling removal of the coupling, bearing bracket and impeller without disturbing the motor, pump housing or pipework.

The unbalanced rubber bellows seal is according to DIN EN 12756.

The pump is fitted with a foot-mounted, fan-cooled, permanent-magnet synchronous motor. Pump and motor are mounted on a common base frame.

The motor includes a frequency converter and PI controller in the motor terminal box. This enables continuously variable control of the motor speed, which again enables adaptation of the performance to a given requirement.

The product's minimum efficiency index (MEI) is greater or equal to 0.70. This is by the Commission Regulation (EU) considered as an indicative benchmark for best-performing water pump available on the market as from 1 January 2013.

An external sensor can be connected if controlled pump operation is required for flow, differential pressure or temperature control.

The operating panel on the motor terminal box features a four-inch TFT display, push-buttons and the Grundfos Eye indicator.

The display gives an intuitive and user-friendly interface to all functions.

The push-buttons are used to navigate through the menu structure to access pump and performance data on site and enable setting of required setpoint as well as setting of pump to "Min." or "Max." operation or to "Stop".

The Grundfos Eye indicator on the operating panel provides visual indication of pump status:

- "Power on": Motor is running (rotating green indicator lights) or not running (permanently green indicator lights)
- "Warning": Motor is still running (rotating yellow indicator lights) or has stopped (permanently yellow indicator lights)
- "Alarm": Motor has stopped (flashing red indicator lights).

Communication with the pump is also possible by means of Grundfos GO Remote (accessory). The remote control enables further settings as well as reading out of a number of parameters such as "Actual value", "Speed", "Power input" and total "Power consumption".

Pump and motor are mounted on a common steel base frame in accordance with ISO 3661.

The back pull-out design together with a spacer coupling makes it possible to service the pump without dismantling the pump housing and motor from the base frame.

This saves realignment of pump and motor after service.

- 1) Remove coupling.
- 2) Remove the bolts in the bearing bracket support foot.
- 3) Remove the bearing bracket from the pump housing.

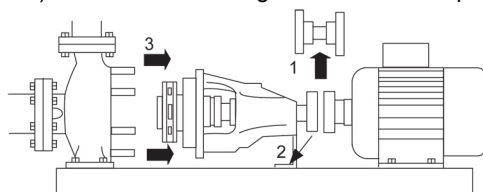

**Pump**

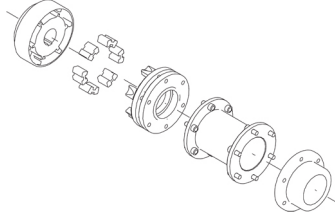
Qty.	Description								
	<p>The pump housing has both a priming and a drain hole closed by plugs. The impeller is a closed impeller with double-curved blades with smooth surfaces. The impeller is statically balanced according to ISO 1940-1 class G6.3 and hydraulically balanced to compensate for axial thrust.</p> <p>Wear rings used in pump housing and for impeller are made of bronze/brass.</p> <p>The pump is fitted with an unbalanced rubber bellows seal with torque transmission across the spring and around the bellows. Due to the bellows, the seal does not wear the shaft, and the axial movement is not prevented by deposits on the shaft.</p> <p>{IMG Filename: GRALON_NB-NK-G_SHAFTSEAL_Bxxx.gif }</p> <p>Seal faces:</p> <ul style="list-style-type: none"> <li>• Rotating seal ring material: silicon carbide (SiC)</li> <li>• Stationary seat material: silicon carbide (SiC)</li> </ul> <p>This material pairing is used where higher corrosion resistance is required. The high hardness of this material pairing offers good resistance against abrasive particles.</p> <p>Secondary seal material: EPDM (ethylene-propylene rubber)</p> <p>EPDM has excellent resistance to hot water. EPDM is not suitable for mineral oils.</p> <p>The shaft is made of stainless steel and has a diameter of 24 mm where the coupling is mounted.</p> <p>The pump uses a spacer coupling between the pump and motor shaft.</p>  <p><b>Motor</b></p> <p>The motor is a totally enclosed, fan-cooled motor with principal dimensions to IEC and DIN standards. Electrical tolerances comply with IEC 60034.</p> <p>The motor efficiency is classified as IE5 in accordance with IEC 60034-30-2.</p> <p>The motor requires no external motor protection. The motor control unit incorporates protection against slow- and quick-rising temperatures, e.g. constant overload and stalled conditions.</p> <p>The terminal box holds terminals for these connections:</p> <ul style="list-style-type: none"> <li>- one dedicated digital input</li> <li>- two analog inputs, 0(4)-20 mA, 0-5 V, 0-10 V, 0.5 - 3.5 V</li> <li>- 5 V voltage supply to potentiometer and sensor</li> <li>- one configurable digital input or open-collector output</li> <li>- Grundfos Digital Sensor input and output</li> <li>- 24 V voltage supply for sensors</li> <li>- two signal-relay outputs (potential-free contacts)</li> <li>- GENIbus connection</li> <li>- interface for Grundfos CIM fieldbus module.</li> </ul> <p><b>Further product details</b></p> <p>Cast-iron parts have an epoxy-based coating made in a cathodic electro-deposition (CED) process. CED is a high-quality dip-painting process where an electrical field around the products ensures deposition of paint particles as a thin, well-controlled layer on the surface.</p> <p><b>Technical data</b></p> <p>Controls:</p> <table data-bbox="199 1915 638 1982"> <tr> <td>Frequency converter:</td> <td>Built-in</td> </tr> <tr> <td>Pressure sensor:</td> <td>N</td> </tr> </table> <p>Liquid:</p> <table data-bbox="199 2027 702 2094"> <tr> <td>Pumped liquid:</td> <td>Water</td> </tr> <tr> <td>Liquid temperature range:</td> <td>-25 .. 120 °C</td> </tr> </table>	Frequency converter:	Built-in	Pressure sensor:	N	Pumped liquid:	Water	Liquid temperature range:	-25 .. 120 °C
Frequency converter:	Built-in								
Pressure sensor:	N								
Pumped liquid:	Water								
Liquid temperature range:	-25 .. 120 °C								





Company name:

Created by:

Phone:

Date:

16/06/2022

Qty.	Description
------	-------------

	<p>Others: Minimum efficiency index, MEI <math>\geq</math>: 0.70 Net weight: 153 kg Gross weight: 174 kg Shipping volume: 0.44 m<sup>3</sup> Country of origin: HU Custom tariff no.: 84137059</p>
--	--

## On request NKE 65-200/205 AA2F2AESBQQEJWA 50 Hz

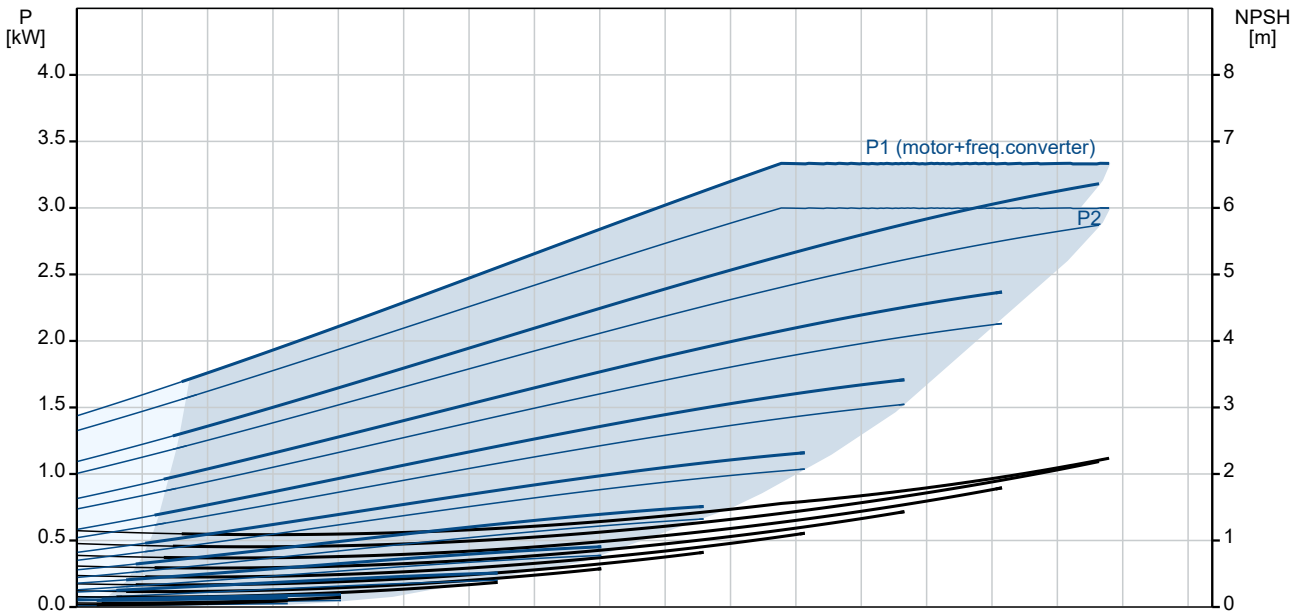
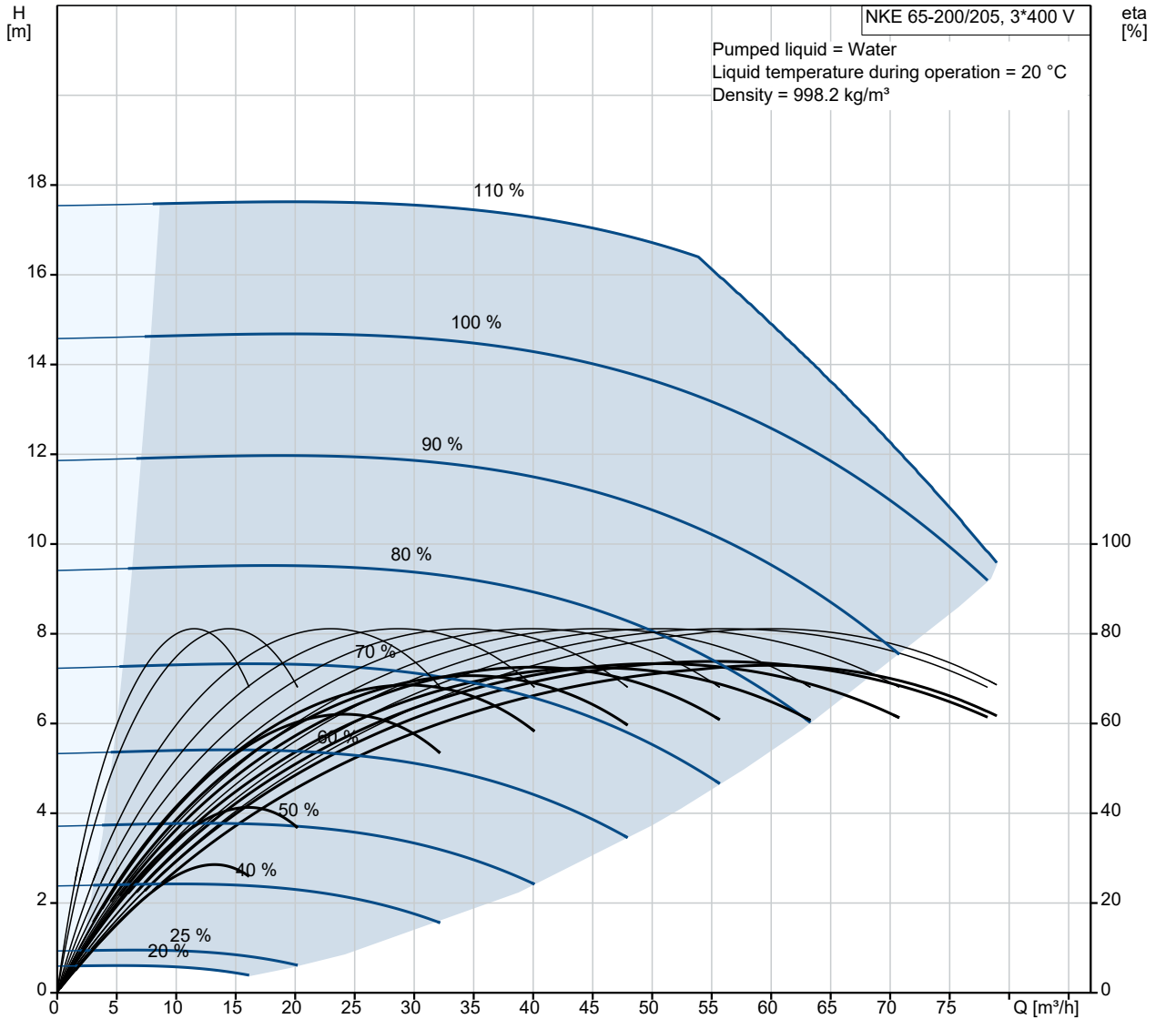

Description	Value
<b>General information:</b>	
Product name:	NKE 65-200/205 AA2F2AESBQQEJWA
Product No:	On request
EAN number:	On request
<b>Technical:</b>	
Pump speed on which pump data are based:	1450 rpm
Rated flow:	60 m <sup>3</sup> /h
Pump with motor (Yes/No):	Y
Rated head:	12.6 m
Actual impeller diameter:	205 mm
Nominal impeller diameter:	200
Shaft diameter:	24 mm
Code for shaft seal:	BQQE
Mechanical seal type:	Single
Curve tolerance:	ISO9906:2012 3B2
Pump version:	A2
Bearing design:	Standard
<b>Materials:</b>	
Pump housing:	Cast iron
Pump housing:	EN-GJL-250
Pump housing:	ASTM class 35
Wear ring:	Brass
Impeller:	Cast iron
Impeller:	EN-GJL-200
Impeller:	ASTM class 30
Internal pump house coating:	CED
Material code:	A
Code for rubber:	E
Shaft:	Stainless steel
Shaft:	EN 1.4301
Shaft:	AISI 304
<b>Installation:</b>	
Range of ambient temperature:	-20 .. 50 °C
Maximum operating pressure:	16 bar
Pipe connection standard:	EN 1092-2
Type of inlet connection:	DIN
Type of outlet connection:	DIN
Size of inlet connection:	DN 80
Size of outlet connection:	DN 65
Pressure rating for connection:	PN 16
Coupling type:	Flexible w/spacer
Base frame design:	EN/ISO
Code for base frame:	5
Grouting (Yes/No):	N
Connect code:	F
<b>Liquid:</b>	
Pumped liquid:	Water
Liquid temperature range:	-25 .. 120 °C
Selected liquid temperature:	20 °C
Density:	998.2 kg/m <sup>3</sup>
<b>Electrical data:</b>	
Motor type:	100LD
IE Efficiency class:	IE5
Rated power - P2:	3 kW
Mains frequency:	50 Hz
Rated voltage:	3 x 380-500 V
Rated current:	5.80-4.60 A

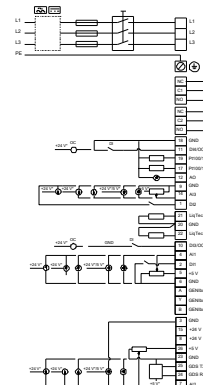
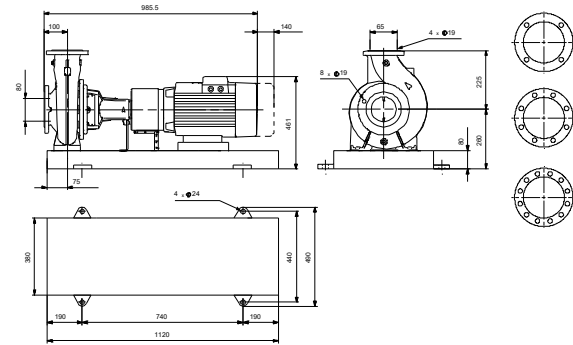
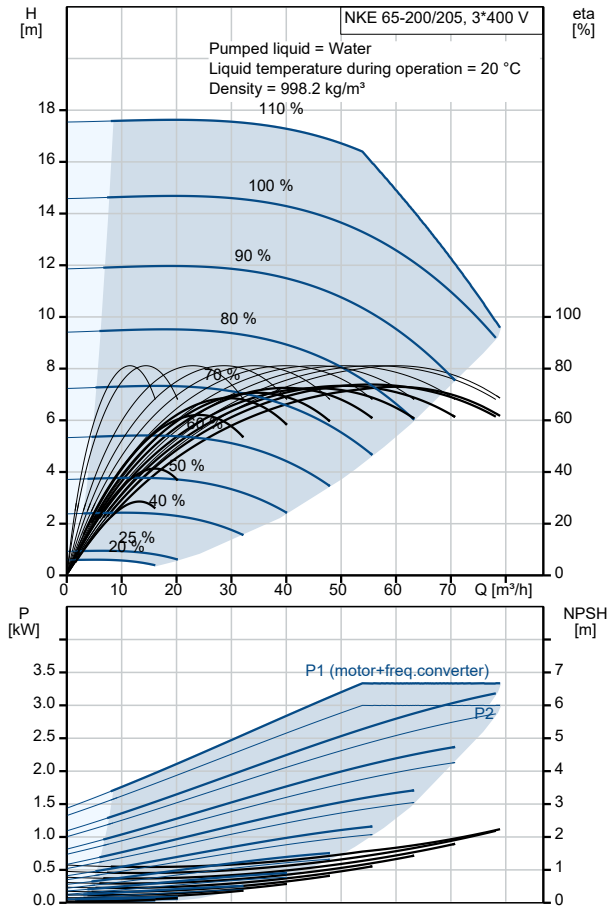



Company name:

Created by:

Phone:

Date:

16/06/2022

Description	Value
Cos phi - power factor:	0.91-0.86
Rated speed:	180-2200 rpm
Efficiency:	90.1%
Motor efficiency at full load:	90.1 %
Number of poles:	4
Enclosure class (IEC 34-5):	IP55
Insulation class (IEC 85):	F
Built-in motor protection:	ELEC
Motor No:	99305881
Bearing insulation type N-end:	STEEL BEARING
<b>Controls:</b>	
Control panel:	HMI300 - Advanced
Function Module:	FM300 - Advanced
Frequency converter:	Built-in
Pressure sensor:	N
<b>Others:</b>	
Minimum efficiency index, MEI $\geq$ :	0.70
Net weight:	153 kg
Gross weight:	174 kg
Shipping volume:	0.44 m <sup>3</sup>
Country of origin:	HU
Custom tariff no.:	84137059





## On request NKE 65-200/205 AA2F2AESBQQEJWA 50 Hz



Note! All units are in [mm] unless others are stated.



Company name:

Created by:

Phone:

Date:

16/06/2022

---

**Order Data:**

Product name: NKE 65-200/205

Amount: 1

Product No: On request

Total: Price on request

---