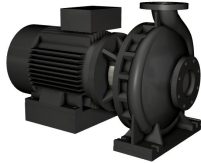

Qty. Description

1 NB 100-400/360 BASF2AESBQQRW3

Product No.: [98975923](#)

Non-self-priming, single-stage, centrifugal volute pump designed according to ISO 5199 with dimensions and rated performance according to EN 733 (10 bar).

Flanges are PN 16 with dimensions according to EN 1092-2. The pump has an axial suction port, radial discharge port, horizontal shaft and a back pull-out design enabling removal of the motor, motor stool, cover and impeller without disturbing the pump housing or pipework.

The unbalanced rubber bellows seal is according to DIN EN 12756.

The pump is close-coupled to a fan-cooled asynchronous motor.

The product's minimum efficiency index (MEI) is greater or equal to 0.70. This is by the Commission Regulation (EU) considered as an indicative benchmark for best-performing water pump available on the market as from 1 January 2013.

The back pull-out design means that the pump can be serviced by a single person without disturbing the pump housing or pipes.



Cast-iron parts have an epoxy-based coating made in a cathodic electro-deposition (CED) process. CED is a high-quality dip-painting process where an electrical field around the products ensures deposition of paint particles as a thin, well-controlled layer on the surface.

Pump

Motor stool and pump cover are made of cast iron (EN-GJL-250). Coupling guards are fitted to the motor stool.

The pump is fitted with an unbalanced rubber bellows seal with torque transmission across the spring and around the bellows. Due to the bellows, the seal does not wear the shaft, and the axial movement is not prevented by deposits on the shaft.

Seal faces:

- Rotating seal ring material: silicon carbide (SiC)
- Stationary seat material: silicon carbide (SiC)

This material pairing is used where higher corrosion resistance is required. The high hardness of this material pairing offers good resistance against abrasive particles.

Secondary seal material: EPDM (ethylene-propylene rubber)

EPDM has excellent resistance to hot water. EPDM is not suitable for mineral oils.

The pump housing has feet.

The pump is to be secured to the foundation with bolts through the pump housing feet and motor feet. The pump is delivered with steel support blocks. The support blocks provide horizontal alignment of the pump and ensure clearance between the motor stool/motor flange and the foundation.

Motor

The motor is a totally enclosed, fan-cooled motor with principal dimensions to IEC and DIN standards. Electrical tolerances comply with IEC 60034.

The motor efficiency is classified as IE3 in accordance with IEC 60034-30-1.

Qty. Description

- 1 The motor has thermistors (PTC sensors) in the windings in accordance with DIN 44081/DIN 44082. The protection reacts to both slow- and quick-rising temperatures, e.g. constant overload and stalled conditions.
- Thermal switches must be connected to an external control circuit in a way which ensures that the automatic reset cannot cause accidents. The motors must be connected to a motor-protective circuit breaker according to local regulations.
- The motor can be connected to a variable speed drive for adjustment of pump performance to any duty point. Grundfos CUE offers a range of variable speed drives. Please find more information in Grundfos Product Center.

Further product details

Cast-iron parts have an epoxy-based coating made in a cathodic electro-deposition (CED) process. CED is a high-quality dip-painting process where an electrical field around the products ensures deposition of paint particles as a thin, well-controlled layer on the surface.

Technical data
Controls:

Frequency converter: NONE

Pressure sensor: N

Liquid:

Pumped liquid: Water

Liquid temperature range: -25 .. 120 °C

Selected liquid temperature: 20 °C

Density: 998.2 kg/m³

Technical:

Pump speed on which pump data are based: 1470 rpm

Rated flow: 187.8 m³/h

Rated head: 39.67 m

Actual impeller diameter: 360 mm

Nominal impeller diameter: 400

Shaft seal arrangement: Single

Code for shaft seal: BQQE

Curve tolerance: ISO9906:2012 3B

Bearing design: Standard

Materials:

Pump housing: Cast iron
EN-GJL-250
ASTM class 35

Wear ring: Brass

Impeller: Cast iron
EN-GJL-200
ASTM class 30

Internal pump house coating: CED

Shaft: Stainless steel
EN 1.4301
AISI 304

Installation:

t max amb: 55 °C

Maximum operating pressure: 16 bar

Pipe connection standard: EN 1092-2

Size of inlet connection: DN 125

Size of outlet connection: DN 100

Pressure rating for connection: PN 16

Bearing lubrication: Grease

Qty. Description

| | |
|---|---|
| 1 | <p>Pump housing with feet: Yes</p> <p>Support block (Yes/No): Y</p> <p>Electrical data:</p> <p>Motor type: SIEMENS</p> <p>IE Efficiency class: IE3</p> <p>Rated power - P2: 30 kW</p> <p>Mains frequency: 50 Hz</p> <p>Rated voltage: 3 x 380-420D/660-725Y V</p> <p>Rated current: 55/32 A</p> <p>Starting current: 730-730 %</p> <p>Cos phi - power factor: 0.84</p> <p>Rated speed: 1470 rpm</p> <p>Efficiency: IE3 93,6%</p> <p>Motor efficiency at full load: 93.6-93.6 %</p> <p>Motor efficiency at 3/4 load: 94-94 %</p> <p>Motor efficiency at 1/2 load: 93.7-93.7 %</p> <p>Number of poles: 4</p> <p>Enclosure class (IEC 34-5): IP55</p> <p>Insulation class (IEC 85): F</p> <p>Motor No: 99032198</p> <p>Bearing insulation type N-end: STEEL BEARING</p> <p>Others:</p> <p>Minimum efficiency index, MEI ≥: 0.70</p> <p>Net weight: 449 kg</p> <p>Gross weight: 482 kg</p> <p>Shipping volume: 0.951 m³</p> <p>Danish VVS No.: 386065403</p> |
|---|---|

98975923 NB 100-400/360 BASF2AESBQQERW3 50 Hz

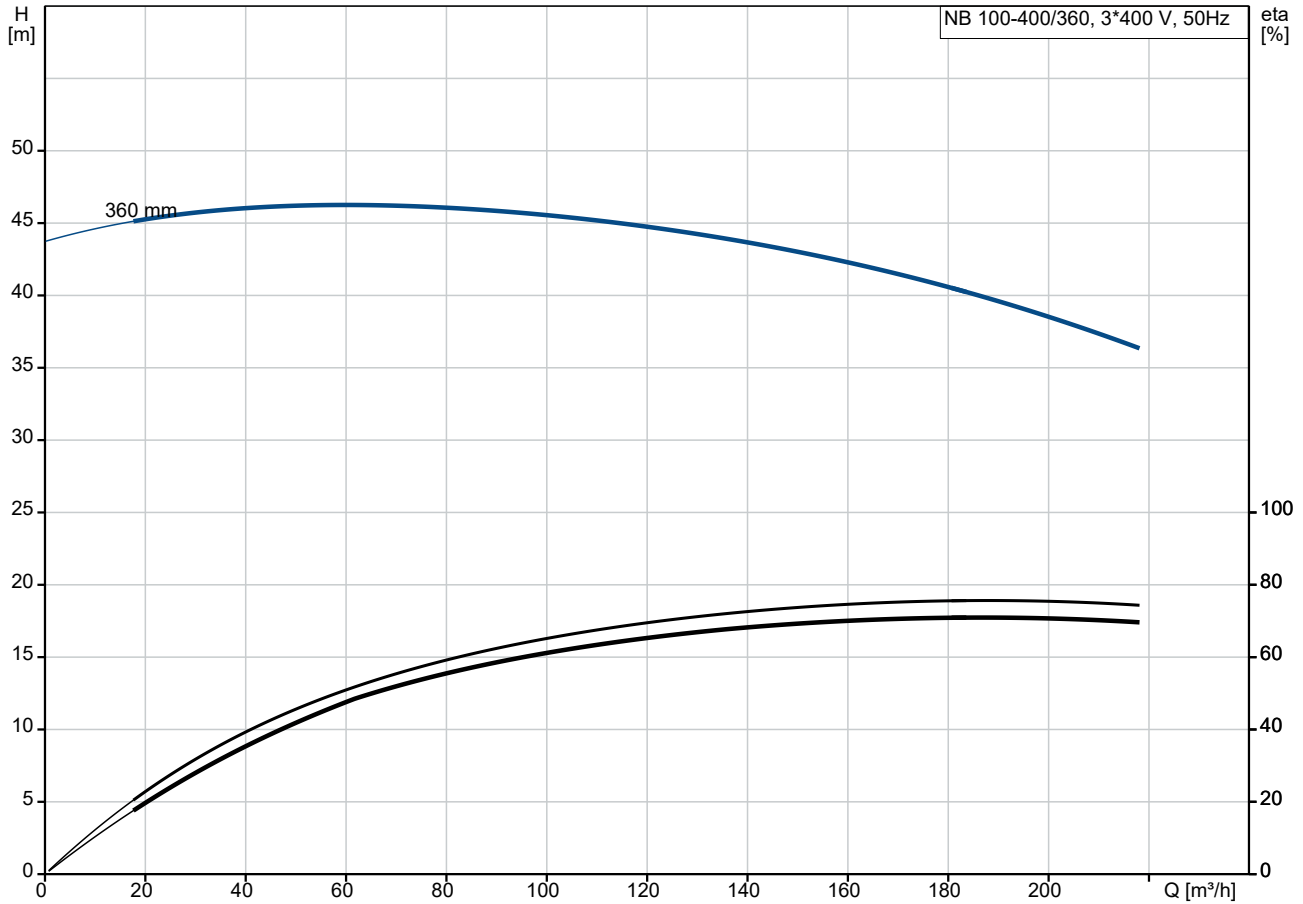

Pumped liquid = Water
Liquid temperature during operation = 20 °C
Density = 998.2 kg/m³

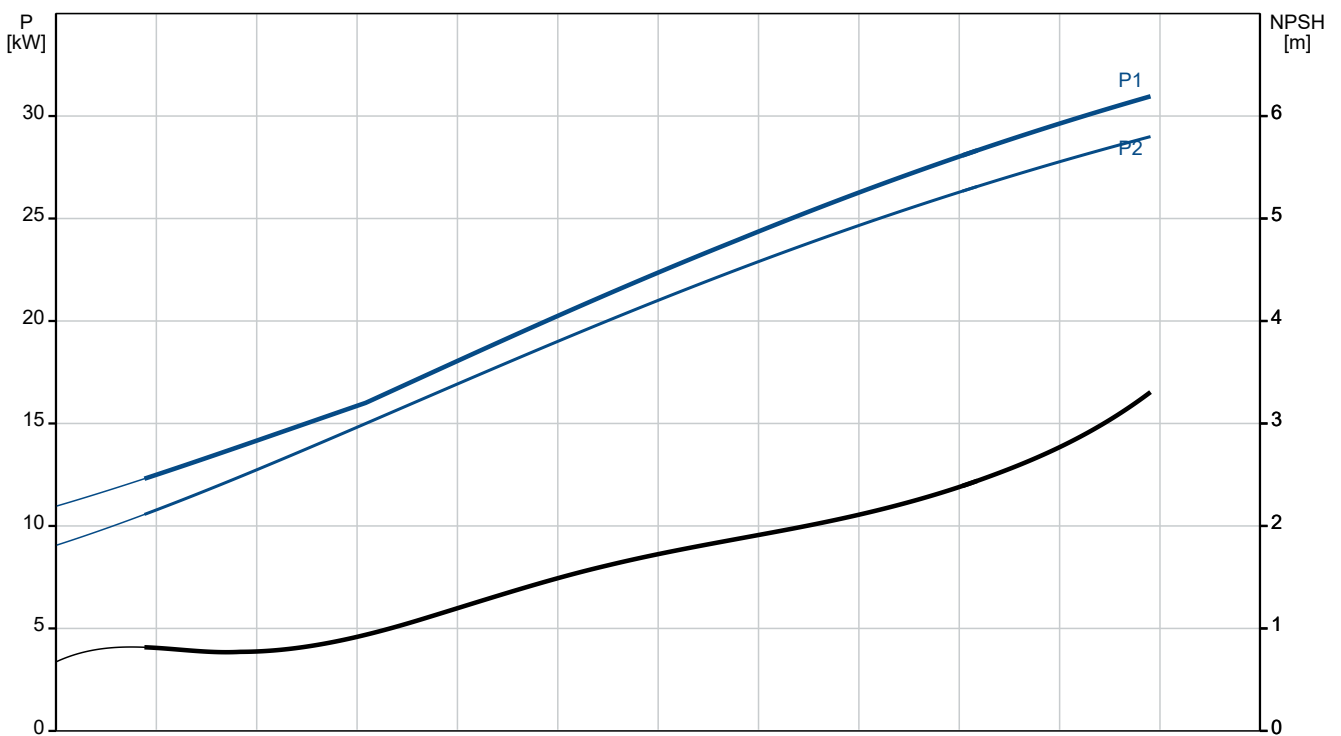

| Description | Value |
|--|----------------------------------|
| General information: | |
| Product name: | NB 100-400/360 BAS2AESBQQERW3 |
| Product No: | 98975923 |
| EAN number: | 5712604552117 |
| Technical: | |
| Pump speed on which pump data are based: | 1470 rpm |
| Rated flow: | 187.8 m ³ /h |
| Rated head: | 39.67 m |
| Actual impeller diameter: | 360 mm |
| Nominal impeller diameter: | 400 |
| Shaft seal arrangement: | Single |
| Shaft diameter: | 42 mm |
| Code for shaft seal: | BQQE |
| Curve tolerance: | ISO9906:2012 3B |
| Pump version: | AS |
| Bearing design: | Standard |
| Materials: | |
| Pump housing: | Cast iron |
| Pump housing: | EN-GJL-250 |
| Pump housing: | ASTM class 35 |
| Wear ring: | Brass |
| Impeller: | Cast iron |
| Impeller: | EN-GJL-200 |
| Impeller: | ASTM class 30 |
| Internal pump house coating: | CED |
| Material code: | A |
| Code for rubber: | E |
| Shaft: | Stainless steel |
| Shaft: | EN 1.4301 |
| Shaft: | AISI 304 |
| Installation: | |
| t max amb: | 55 °C |
| Maximum operating pressure: | 16 bar |
| Pipe connection standard: | EN 1092-2 |
| Size of inlet connection: | DN 125 |
| Size of outlet connection: | DN 100 |
| Pressure rating for connection: | PN 16 |
| Bearing lubrication: | Grease |
| Pump housing with feet: | Yes |
| Support block (Yes/No): | Y |
| Connect code: | F2 |
| Liquid: | |
| Pumped liquid: | Water |
| Liquid temperature range: | -25 .. 120 °C |
| Selected liquid temperature: | 20 °C |
| Density: | 998.2 kg/m ³ |
| Electrical data: | |
| Motor type: | SIEMENS |
| IE Efficiency class: | IE3 |
| Rated power - P2: | 30 kW |
| Mains frequency: | 50 Hz |
| Rated voltage: | 3 x 380-420D/660-725Y V |
| Rated current: | 55/32 A |
| Starting current: | 730-730 % |
| Cos phi - power factor: | 0.84 |
| Rated speed: | 1470 rpm |
| Efficiency: | IE3 93,6% |

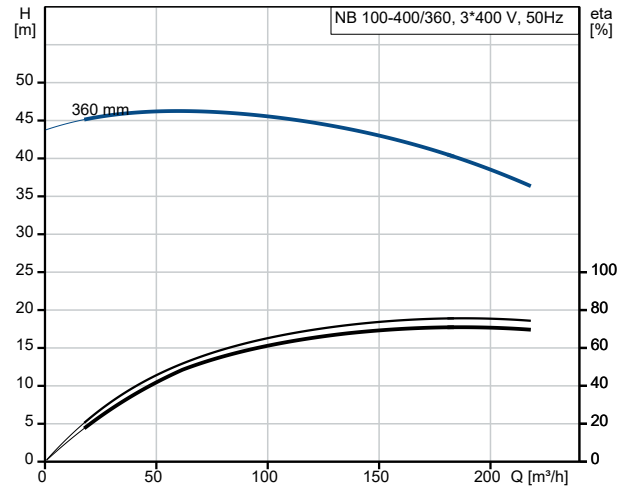

Pumped liquid = Water
Liquid temperature during operation = 20 °C
Density = 998.2 kg/m³

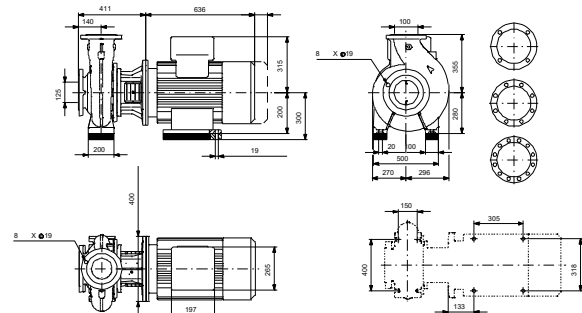
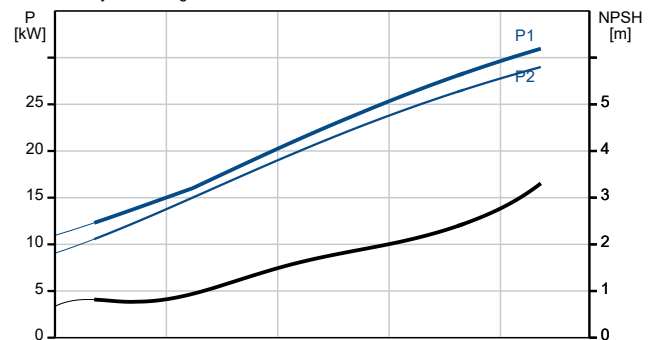



Company name:

Created by:

Phone:

Date:

30/12/2022

| Description | Value |
|--|----------------------|
| Motor efficiency at full load: | 93.6-93.6 % |
| Motor efficiency at 3/4 load: | 94-94 % |
| Motor efficiency at 1/2 load: | 93.7-93.7 % |
| Number of poles: | 4 |
| Enclosure class (IEC 34-5): | IP55 |
| Insulation class (IEC 85): | F |
| Built-in motor protection: | PTC |
| Motor No: | 99032198 |
| Mount. design. acc. IEC 34-7: | IM B35 |
| Bearing insulation type N-end: | STEEL BEARING |
| Controls: | |
| Frequency converter: | NONE |
| Pressure sensor: | N |
| Others: | |
| Minimum efficiency index, MEI \geq : | 0.70 |
| Net weight: | 449 kg |
| Gross weight: | 482 kg |
| Shipping volume: | 0.951 m ³ |
| Danish VVS No.: | 386065403 |

98975923 NB 100-400/360 BASF2AESBQQERW3 50 Hz

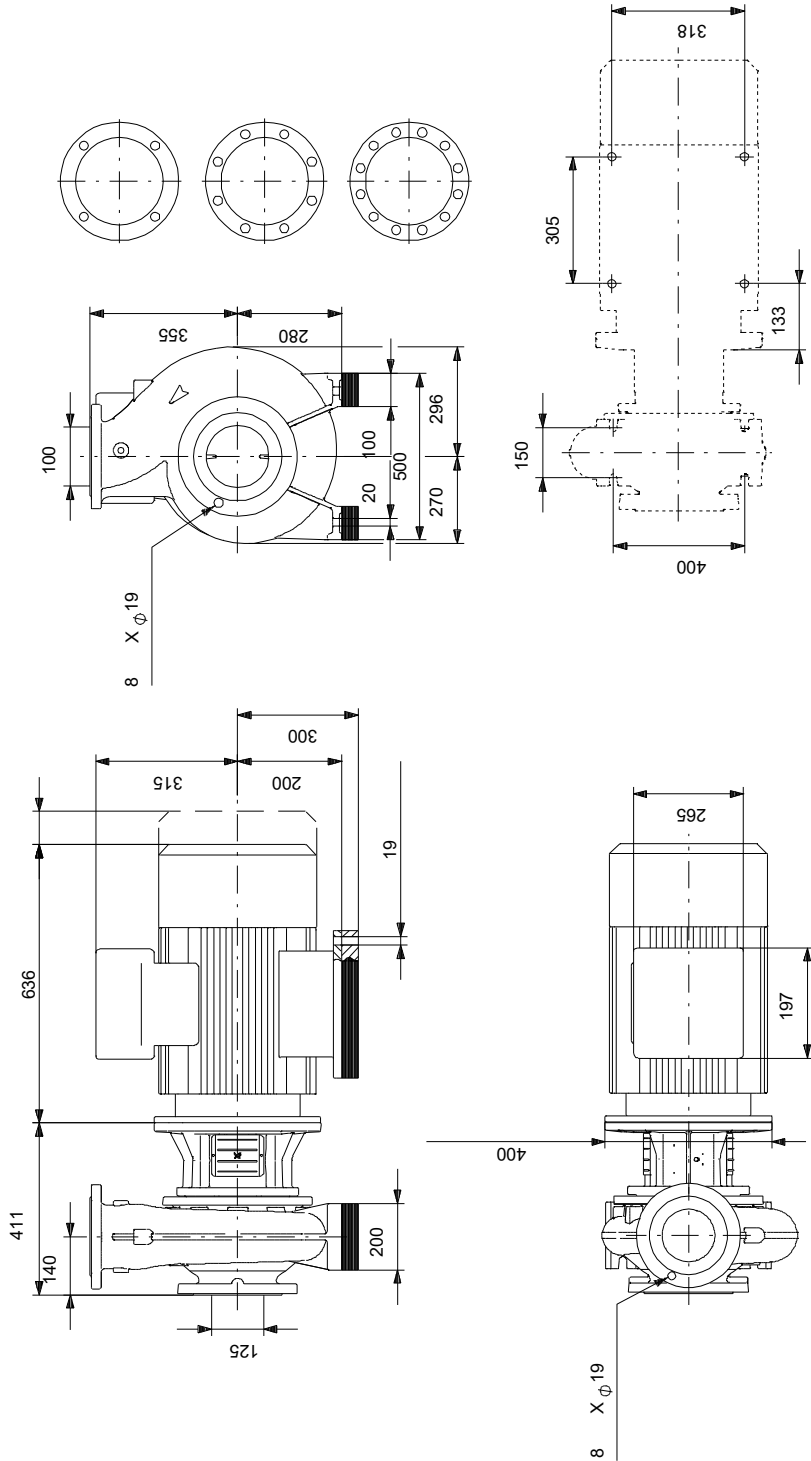

Note! All units are in [mm] unless others are stated.
Disclaimer: This simplified dimensional drawing does not show all details.

98975923 NB 100-400/360 BASF2AESBQQERW3 50 Hz



Note! All units are in [mm] unless others are stated.

