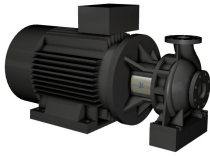

**Qty. Description**

1 NB 80-250/270 AASF2AESBQQEWW1

Product No.: [98975699](#)

Non-self-priming, single-stage, centrifugal volute pump designed according to ISO 5199 with dimensions and rated performance according to EN 733 (10 bar).

Flanges are PN 16 with dimensions according to EN 1092-2. The pump has an axial suction port, radial discharge port, horizontal shaft and a back pull-out design enabling removal of the motor, motor stool, cover and impeller without disturbing the pump housing or pipework.

The unbalanced rubber bellows seal is according to DIN EN 12756.

The pump is close-coupled to a fan-cooled asynchronous motor.

The product's minimum efficiency index (MEI) is greater or equal to 0.70. This is by the Commission Regulation (EU) considered as an indicative benchmark for best-performing water pump available on the market as from 1 January 2013.

The back pull-out design means that the pump can be serviced by a single person without disturbing the pump housing or pipes.

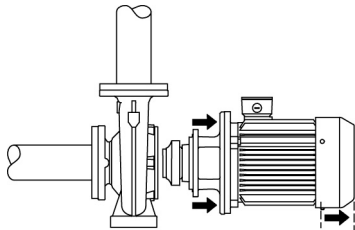

Cast-iron parts have an epoxy-based coating made in a cathodic electro-deposition (CED) process. CED is a high-quality dip-painting process where an electrical field around the products ensures deposition of paint particles as a thin, well-controlled layer on the surface.

## Pump

The pump housing has both a priming and a drain hole closed by plugs. The impeller is a closed impeller with double-curved blades with smooth surfaces. The impeller is statically balanced according to ISO 1940-1 class G6.3 and hydraulically balanced to compensate for axial thrust.

Wear rings used in pump housing and for impeller are made of bronze/brass.

Motor stool and pump cover are made of cast iron (EN-GJL-250). Coupling guards are fitted to the motor stool. The pump cover is provided with a manual air vent screw for venting of the pump housing and the shaft seal chamber.

The pump is fitted with an unbalanced rubber bellows seal with torque transmission across the spring and around the bellows. Due to the bellows, the seal does not wear the shaft, and the axial movement is not prevented by deposits on the shaft.

Seal faces:

- Rotating seal ring material: silicon carbide (SiC)
- Stationary seat material: silicon carbide (SiC)

This material pairing is used where higher corrosion resistance is required. The high hardness of this material pairing offers good resistance against abrasive particles.

Secondary seal material: EPDM (ethylene-propylene rubber)

EPDM has excellent resistance to hot water. EPDM is not suitable for mineral oils.

The pump housing has feet.

The pump is to be secured to the foundation with bolts through the pump housing feet and motor feet. The pump is delivered with steel support blocks. The support blocks provide horizontal alignment of the pump and ensure clearance between the motor stool/motor flange and the foundation.

Qty.	Description
1	<p><b>Motor</b></p> <p>The motor is a totally enclosed, fan-cooled motor with principal dimensions to IEC and DIN standards. Electrical tolerances comply with IEC 60034.</p> <p>The motor efficiency is classified as IE3 in accordance with IEC 60034-30-1.</p> <p>The motor has thermistors (PTC sensors) in the windings in accordance with DIN 44081/DIN 44082. The protection reacts to both slow- and quick-rising temperatures, e.g. constant overload and stalled conditions.</p> <p>Thermal switches must be connected to an external control circuit in a way which ensures that the automatic reset cannot cause accidents. The motors must be connected to a motor-protective circuit breaker according to local regulations.</p> <p>A variable speed drive makes adjustment of pump performance to any duty point possible. If the motor is to be connected to a variable speed drive, the pump must be ordered with an electrically insulated motor bearing.</p> <p><b>Further product details</b></p> <p>Cast-iron parts have an epoxy-based coating made in a cathodic electro-deposition (CED) process. CED is a high-quality dip-painting process where an electrical field around the products ensures deposition of paint particles as a thin, well-controlled layer on the surface.</p> <p><b>Technical data</b></p> <p>Controls:</p> <p>Frequency converter: NONE</p> <p>Pressure sensor: N</p> <p>Liquid:</p> <p>Pumped liquid: Water</p> <p>Liquid temperature range: -25 .. 120 °C</p> <p>Selected liquid temperature: 20 °C</p> <p>Density: 998.2 kg/m<sup>3</sup></p> <p>Technical:</p> <p>Pump speed on which pump data are based: 2975 rpm</p> <p>Rated flow: 250 m<sup>3</sup>/h</p> <p>Rated head: 93.24 m</p> <p>Actual impeller diameter: 270 mm</p> <p>Nominal impeller diameter: 250</p> <p>Shaft seal arrangement: Single</p> <p>Code for shaft seal: BQQE</p> <p>Curve tolerance: ISO9906:2012 3B</p> <p>Bearing design: Standard</p> <p>Materials:</p> <p>Pump housing: Cast iron EN-GJL-250 ASTM class 35</p> <p>Wear ring: Brass</p> <p>Impeller: Cast iron EN-GJL-200 ASTM class 30</p> <p>Internal pump house coating: CED</p> <p>Shaft: Stainless steel EN 1.4301 AISI 304</p> <p>Installation:</p> <p>t max amb: 55 °C</p> <p>Maximum operating pressure: 16 bar</p> <p>Pipe connection standard: EN 1092-2</p>

Qty.	Description
1	<p>Size of inlet connection: DN 100            Size of outlet connection: DN 80            Pressure rating for connection: PN 16            Bearing lubrication: Grease            Pump housing with feet: Yes            Support block (Yes/No): Y</p> <p>Electrical data:            Motor type: SIEMENS            IE Efficiency class: IE3            Rated power - P2: 90 kW            Mains frequency: 50 Hz            Rated voltage: 3 x 380-420D/660-725Y V            Rated current: 152/88 A            Starting current: 720-720 %            Cos phi - power factor: 0.90            Rated speed: 2975 rpm            Efficiency: IE3 95,0%            Motor efficiency at full load: 95.0-95.0 %            Motor efficiency at 3/4 load: 95.1-95.1 %            Motor efficiency at 1/2 load: 94.6-94.6 %            Number of poles: 2            Enclosure class (IEC 34-5): IP55            Insulation class (IEC 85): F            Motor No: 83U15442            Bearing insulation type N-end: STEEL BEARING</p> <p>Others:            Minimum efficiency index, MEI ≥: 0.70            Net weight: 739 kg            Gross weight: 765 kg            Shipping volume: 0.848 m<sup>3</sup>            Danish VVS No.: 386064256            Country of origin: HU            Custom tariff no.: 84137051</p>



Company name: Pump Sales Direct  
Created by:  
Phone:

Date: 15/08/2022

### 98975699 NB 80-250/270 AASF2AESBQQEWW1 50 Hz

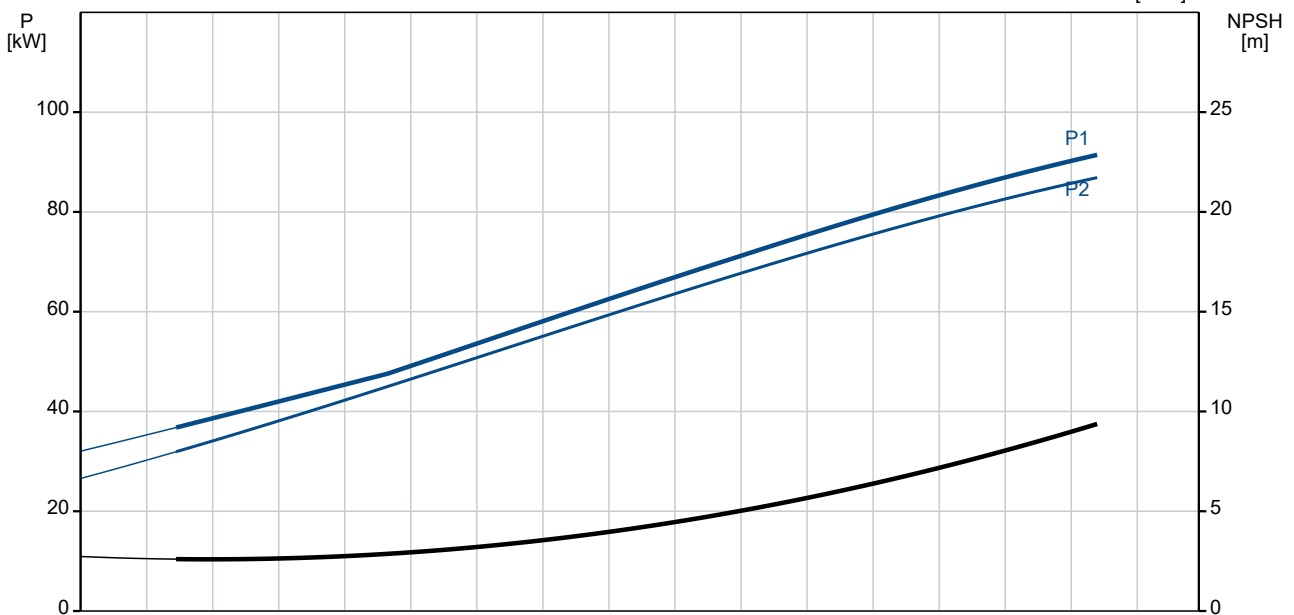
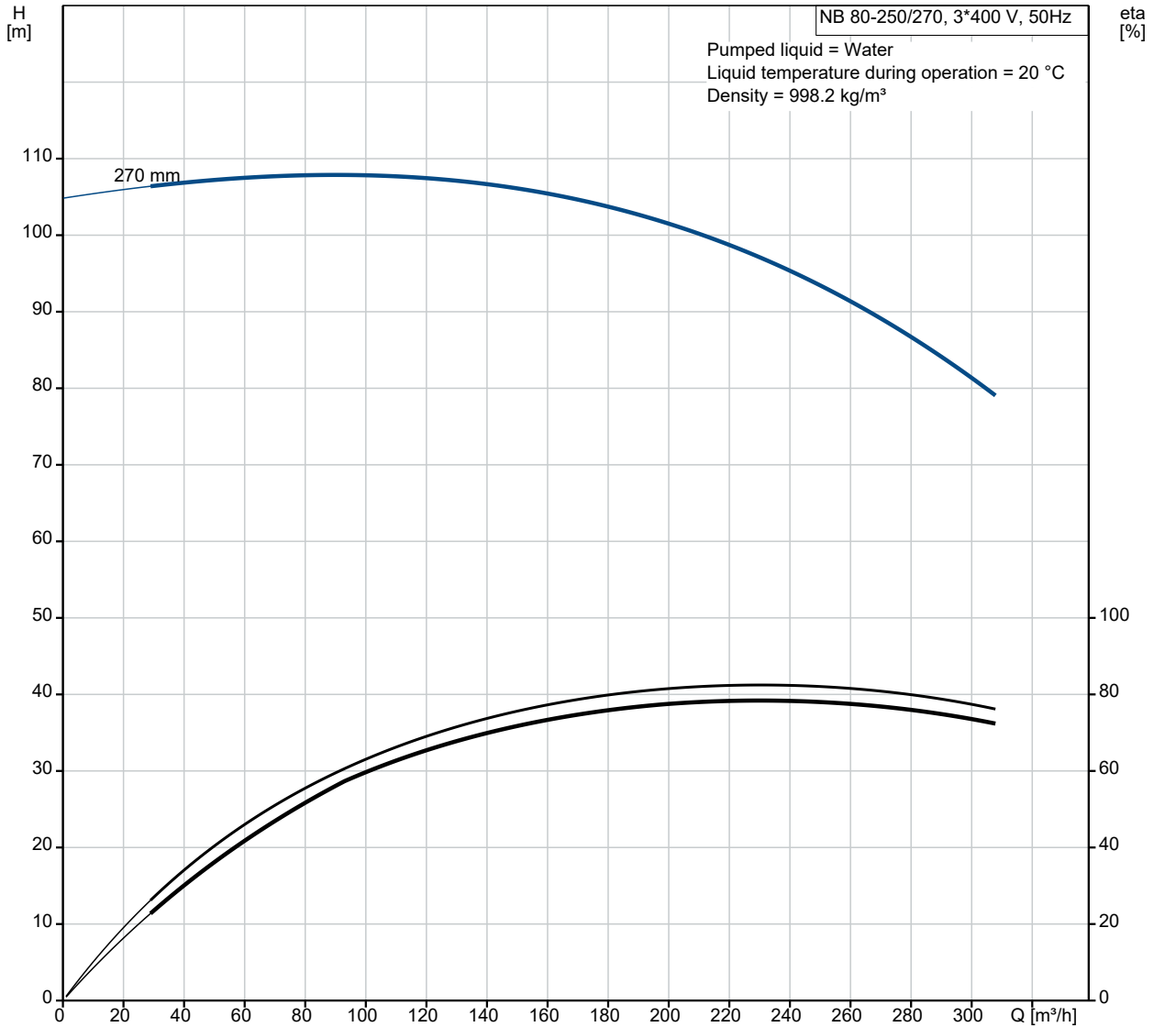

Description	Value
<b>General information:</b>	
Product name:	NB 80-250/270 AASF2AESBQQEWW1
Product No:	98975699
EAN number:	5712604547786
<b>Technical:</b>	
Pump speed on which pump data are based:	2975 rpm
Rated flow:	250 m <sup>3</sup> /h
Rated head:	93.24 m
Actual impeller diameter:	270 mm
Nominal impeller diameter:	250
Shaft seal arrangement:	Single
Shaft diameter:	32 mm
Code for shaft seal:	BQQE
Curve tolerance:	ISO9906:2012 3B
Pump version:	AS
Bearing design:	Standard
<b>Materials:</b>	
Pump housing:	Cast iron
Pump housing:	EN-GJL-250
Pump housing:	ASTM class 35
Wear ring:	Brass
Impeller:	Cast iron
Impeller:	EN-GJL-200
Impeller:	ASTM class 30
Internal pump house coating:	CED
Material code:	A
Code for rubber:	E
Shaft:	Stainless steel
Shaft:	EN 1.4301
Shaft:	AISI 304
<b>Installation:</b>	
t max amb:	55 °C
Maximum operating pressure:	16 bar
Pipe connection standard:	EN 1092-2
Size of inlet connection:	DN 100
Size of outlet connection:	DN 80
Pressure rating for connection:	PN 16
Bearing lubrication:	Grease
Pump housing with feet:	Yes
Support block (Yes/No):	Y
Connect code:	F2
<b>Liquid:</b>	
Pumped liquid:	Water
Liquid temperature range:	-25 .. 120 °C
Selected liquid temperature:	20 °C
Density:	998.2 kg/m <sup>3</sup>
<b>Electrical data:</b>	
Motor type:	SIEMENS
IE Efficiency class:	IE3
Rated power - P2:	90 kW
Mains frequency:	50 Hz
Rated voltage:	3 x 380-420D/660-725Y V
Rated current:	152/88 A
Starting current:	720-720 %
Cos phi - power factor:	0.90
Rated speed:	2975 rpm
Efficiency:	IE3 95,0%

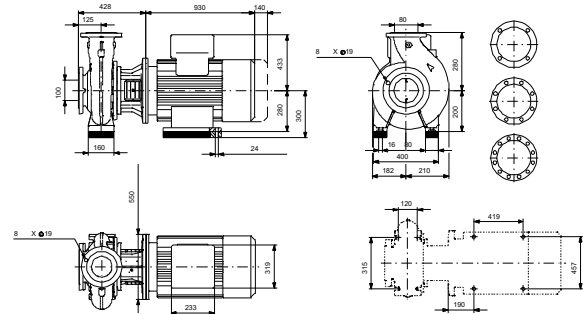
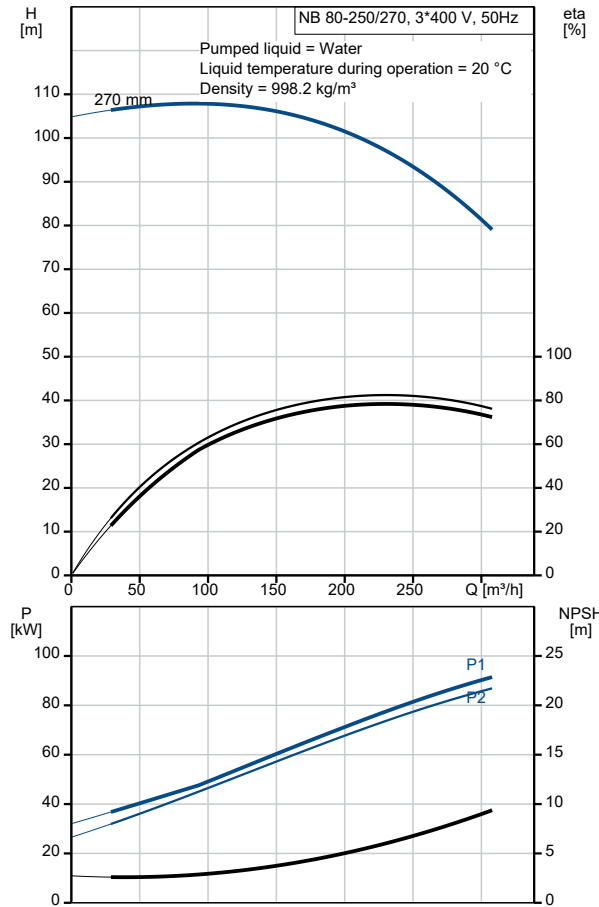



Company name: Pump Sales Direct

Created by:

Phone:

Date: 15/08/2022

Description	Value
Motor efficiency at full load:	95.0-95.0 %
Motor efficiency at 3/4 load:	95.1-95.1 %
Motor efficiency at 1/2 load:	94.6-94.6 %
Number of poles:	2
Enclosure class (IEC 34-5):	IP55
Insulation class (IEC 85):	F
Built-in motor protection:	PTC
Motor No:	83U15442
Mount. design. acc. IEC 34-7:	IM B35
Bearing insulation type N-end:	STEEL BEARING
<b>Controls:</b>	
Frequency converter:	NONE
Pressure sensor:	N
<b>Others:</b>	
Minimum efficiency index, MEI $\geq$ :	0.70
Net weight:	739 kg
Gross weight:	765 kg
Shipping volume:	0.848 m <sup>3</sup>
Danish VVS No.:	386064256
Country of origin:	HU
Custom tariff no.:	84137051

## 98975699 NB 80-250/270 AASF2AESBQQEWW1 50 Hz

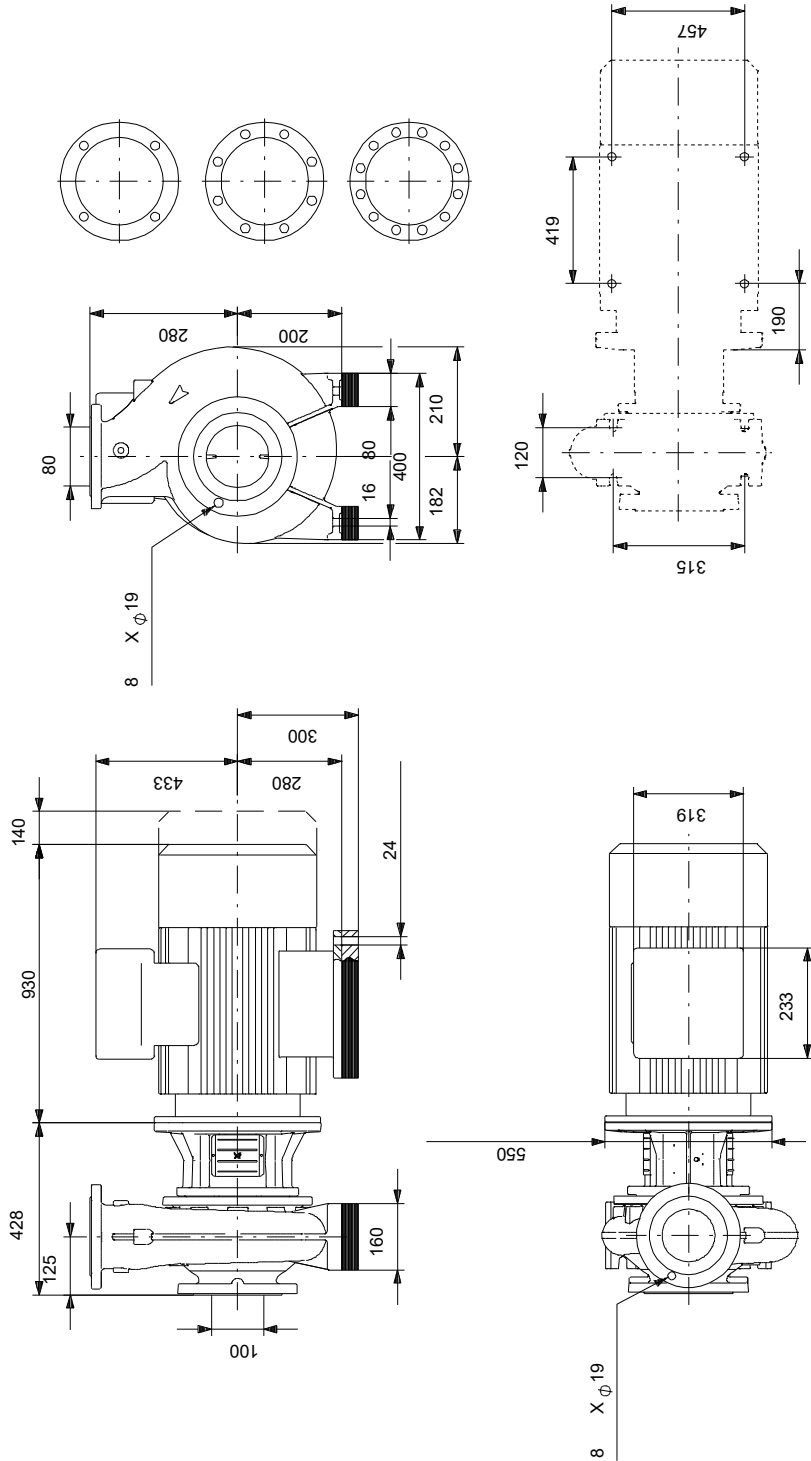

Note! All units are in [mm] unless others are stated.  
 Disclaimer: This simplified dimensional drawing does not show all details.

## 98975699 NB 80-250/270 AASF2AESBQQEWW1 50 Hz



IEC TP211 THERMALLY PROTECTED WHEN THE THERMISTORS ARE  
CONNECTED TO AMPLIFIER RELAY FOR CONTROL OF MAIN SUPPLY  
THERMISTORS PTC ACCORDING TO DIN 44082

Note! All units are in [mm] unless others are stated.



