

Qty. Description

1 **NK 100-250/258 BA2F2AESBQQE1W1**



Note! Product picture may differ from actual product

Product No.: [98973181](#)

Non-self-priming, single-stage, centrifugal pump designed according to ISO 5199 with dimensions and rated performance according to EN 733. Flanges are PN 16 with dimensions according to EN 1092-2. The pump has an axial suction port, a radial discharge port and horizontal shaft. It is of the back pull-out design enabling removal of the coupling, bearing bracket and impeller without disturbing the motor, pump housing or pipework.

The unbalanced rubber bellows seal is according to DIN EN 12756.

The pump is fitted with a foot-mounted, fan-cooled asynchronous motor. Pump and motor are mounted on a common base frame.

The product's minimum efficiency index (MEI) is greater or equal to 0.70. This is by the Commission Regulation (EU) considered as an indicative benchmark for best-performing water pump available on the market as from 1 January 2013.

Pump and motor are mounted on a common steel base frame in accordance with ISO 3661.

The back pull-out design together with a spacer coupling makes it possible to service the pump without dismantling the pump housing and motor from the base frame.

This saves realignment of pump and motor after service.

- 1) Remove coupling.
- 2) Remove the bolts in the bearing bracket support foot.
- 3) Remove the bearing bracket from the pump housing.

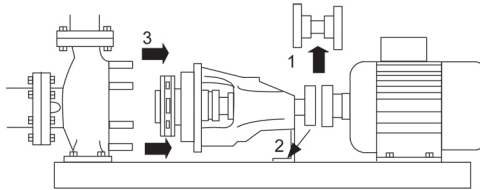

Pump

The pump is fitted with an unbalanced rubber bellows seal with torque transmission across the spring and around the bellows. Due to the bellows, the seal does not wear the shaft, and the axial movement is not prevented by deposits on the shaft.

{IMG Filename: GRALON_NB-NK-G_SHAFTSEAL_Bxxx.gif }

Seal faces:

- Rotating seal ring material: silicon carbide (SiC)
- Stationary seat material: silicon carbide (SiC)

This material pairing is used where higher corrosion resistance is required. The high hardness of this material pairing offers good resistance against abrasive particles.

Secondary seal material: EPDM (ethylene-propylene rubber)

EPDM has excellent resistance to hot water. EPDM is not suitable for mineral oils.

The shaft is made of stainless steel and has a diameter of 32 mm where the coupling is mounted.

The pump uses a spacer coupling between the pump and motor shaft.

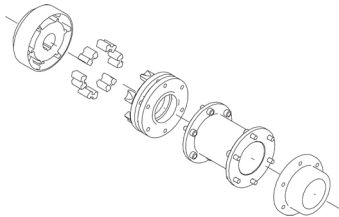

The base frame is prepared for grouting. Grouting improves the contact of the base frame with the foundation and stiffens the base frame construction. This changes the vibration level.

Qty.	Description																																																		
1	<p data-bbox="201 163 1422 237">Grouting is mandatory for all base frame types for all 2-pole pumps equal to and above 55 kW to fulfill the max vibration level requirements stated in standards. For other pump motor combinations grouting of the base frame is optional.</p> <p data-bbox="201 277 284 306">Motor</p> <p data-bbox="201 313 1394 362">The motor is a totally enclosed, fan-cooled motor with principal dimensions to IEC and DIN standards. Electrical tolerances comply with IEC 60034.</p> <p data-bbox="201 369 1016 398">The motor efficiency is classified as IE3 in accordance with IEC 60034-30-1.</p> <p data-bbox="201 405 1434 454">The motor has thermistors (PTC sensors) in the windings in accordance with DIN 44081/DIN 44082. The protection reacts to both slow- and quick-rising temperatures, e.g. constant overload and stalled conditions.</p> <p data-bbox="201 461 1422 535">Thermal switches must be connected to an external control circuit in a way which ensures that the automatic reset cannot cause accidents. The motors must be connected to a motor-protective circuit breaker according to local regulations.</p> <p data-bbox="201 542 1382 591">A variable speed drive makes adjustment of pump performance to any duty point possible. If the motor is to be connected to a variable speed drive, the pump must be ordered with an electrically insulated motor bearing.</p> <p data-bbox="201 663 512 692">Further product details</p> <p data-bbox="201 698 1457 772">Cast-iron parts have an epoxy-based coating made in a cathodic electro-deposition (CED) process. CED is a high-quality dip-painting process where an electrical field around the products ensures deposition of paint particles as a thin, well-controlled layer on the surface.</p> <p data-bbox="201 844 400 873">Technical data</p> <p data-bbox="201 907 300 936">Controls:</p> <table data-bbox="201 936 638 992"> <tr> <td data-bbox="201 936 432 965">Frequency converter:</td> <td data-bbox="564 936 636 965">NONE</td> </tr> <tr> <td data-bbox="201 965 384 992">Pressure sensor:</td> <td data-bbox="564 965 580 992">N</td> </tr> </table> <p data-bbox="201 1025 276 1055">Liquid:</p> <table data-bbox="201 1055 703 1171"> <tr> <td data-bbox="201 1055 363 1084">Pumped liquid:</td> <td data-bbox="564 1055 632 1084">Water</td> </tr> <tr> <td data-bbox="201 1084 480 1113">Liquid temperature range:</td> <td data-bbox="564 1084 703 1113">-25 .. 120 °C</td> </tr> <tr> <td data-bbox="201 1113 504 1142">Selected liquid temperature:</td> <td data-bbox="564 1113 628 1142">20 °C</td> </tr> <tr> <td data-bbox="201 1142 292 1171">Density:</td> <td data-bbox="564 1142 695 1171">998.2 kg/m³</td> </tr> </table> <p data-bbox="201 1205 312 1234">Technical:</p> <table data-bbox="201 1234 820 1529"> <tr> <td data-bbox="201 1234 687 1263">Pump speed on which pump data are based:</td> <td data-bbox="715 1234 820 1263">2982 rpm</td> </tr> <tr> <td data-bbox="201 1263 320 1292">Rated flow:</td> <td data-bbox="564 1263 683 1292">324.6 m³/h</td> </tr> <tr> <td data-bbox="201 1292 496 1321">Pump with motor (Yes/No):</td> <td data-bbox="564 1292 580 1321">Y</td> </tr> <tr> <td data-bbox="201 1321 336 1350">Rated head:</td> <td data-bbox="564 1321 655 1350">81.94 m</td> </tr> <tr> <td data-bbox="201 1350 472 1379">Actual impeller diameter:</td> <td data-bbox="564 1350 655 1379">258 mm</td> </tr> <tr> <td data-bbox="201 1379 488 1408">Nominal impeller diameter:</td> <td data-bbox="564 1379 608 1408">250</td> </tr> <tr> <td data-bbox="201 1408 416 1438">Code for shaft seal:</td> <td data-bbox="564 1408 639 1438">BQQE</td> </tr> <tr> <td data-bbox="201 1438 440 1467">Mechanical seal type:</td> <td data-bbox="564 1438 632 1467">Single</td> </tr> <tr> <td data-bbox="201 1467 384 1496">Curve tolerance:</td> <td data-bbox="564 1467 759 1496">ISO9906:2012 3B</td> </tr> <tr> <td data-bbox="201 1496 368 1525">Bearing design:</td> <td data-bbox="564 1496 663 1525">Standard</td> </tr> </table> <p data-bbox="201 1563 308 1592">Materials:</p> <table data-bbox="201 1592 732 1910"> <tr> <td data-bbox="201 1592 363 1621">Pump housing:</td> <td data-bbox="564 1592 732 1673">Cast iron EN-GJL-250 ASTM class 35</td> </tr> <tr> <td data-bbox="201 1673 316 1702">Wear ring:</td> <td data-bbox="564 1673 632 1702">Brass</td> </tr> <tr> <td data-bbox="201 1702 292 1731">Impeller:</td> <td data-bbox="564 1702 732 1794">Cast iron EN-GJL-200 ASTM class 30</td> </tr> <tr> <td data-bbox="201 1794 515 1823">Internal pump house coating:</td> <td data-bbox="564 1794 619 1823">CED</td> </tr> <tr> <td data-bbox="201 1823 268 1852">Shaft:</td> <td data-bbox="564 1823 724 1910">Stainless steel EN 1.4301 AISI 304</td> </tr> </table> <p data-bbox="201 1944 325 1973">Installation:</p> <table data-bbox="201 1973 684 2089"> <tr> <td data-bbox="201 1973 320 2002">t max amb:</td> <td data-bbox="564 1973 628 2002">55 °C</td> </tr> <tr> <td data-bbox="201 2002 523 2031">Maximum operating pressure:</td> <td data-bbox="564 2002 636 2031">16 bar</td> </tr> <tr> <td data-bbox="201 2031 480 2060">Pipe connection standard:</td> <td data-bbox="564 2031 684 2060">EN 1092-2</td> </tr> <tr> <td data-bbox="201 2060 464 2089">Type of inlet connection:</td> <td data-bbox="564 2060 608 2089">DIN</td> </tr> </table>	Frequency converter:	NONE	Pressure sensor:	N	Pumped liquid:	Water	Liquid temperature range:	-25 .. 120 °C	Selected liquid temperature:	20 °C	Density:	998.2 kg/m ³	Pump speed on which pump data are based:	2982 rpm	Rated flow:	324.6 m ³ /h	Pump with motor (Yes/No):	Y	Rated head:	81.94 m	Actual impeller diameter:	258 mm	Nominal impeller diameter:	250	Code for shaft seal:	BQQE	Mechanical seal type:	Single	Curve tolerance:	ISO9906:2012 3B	Bearing design:	Standard	Pump housing:	Cast iron EN-GJL-250 ASTM class 35	Wear ring:	Brass	Impeller:	Cast iron EN-GJL-200 ASTM class 30	Internal pump house coating:	CED	Shaft:	Stainless steel EN 1.4301 AISI 304	t max amb:	55 °C	Maximum operating pressure:	16 bar	Pipe connection standard:	EN 1092-2	Type of inlet connection:	DIN
Frequency converter:	NONE																																																		
Pressure sensor:	N																																																		
Pumped liquid:	Water																																																		
Liquid temperature range:	-25 .. 120 °C																																																		
Selected liquid temperature:	20 °C																																																		
Density:	998.2 kg/m ³																																																		
Pump speed on which pump data are based:	2982 rpm																																																		
Rated flow:	324.6 m ³ /h																																																		
Pump with motor (Yes/No):	Y																																																		
Rated head:	81.94 m																																																		
Actual impeller diameter:	258 mm																																																		
Nominal impeller diameter:	250																																																		
Code for shaft seal:	BQQE																																																		
Mechanical seal type:	Single																																																		
Curve tolerance:	ISO9906:2012 3B																																																		
Bearing design:	Standard																																																		
Pump housing:	Cast iron EN-GJL-250 ASTM class 35																																																		
Wear ring:	Brass																																																		
Impeller:	Cast iron EN-GJL-200 ASTM class 30																																																		
Internal pump house coating:	CED																																																		
Shaft:	Stainless steel EN 1.4301 AISI 304																																																		
t max amb:	55 °C																																																		
Maximum operating pressure:	16 bar																																																		
Pipe connection standard:	EN 1092-2																																																		
Type of inlet connection:	DIN																																																		

Qty.	Description
1	<p>Type of outlet connection: DIN Size of inlet connection: DN 125 Size of outlet connection: DN 100 Pressure rating for connection: PN 16 Coupling type: Flexible w/spacer Base frame design: EN/ISO Code for base frame: 10 Grouting (Yes/No): Y</p> <p>Electrical data:</p> <p>Motor type: SIEMENS IE Efficiency class: IE3 Rated power - P2: 110 kW Mains frequency: 50 Hz Rated voltage: 3 x 380-420D/660-725Y V Rated current: 183/106 A Starting current: 710-710 % Cos phi - power factor: 0.91 Rated speed: 2982 rpm Efficiency: IE3 95,2% Motor efficiency at full load: 95.2-95.2 % Motor efficiency at 3/4 load: 95.4-95.4 % Motor efficiency at 1/2 load: 94.9-94.9 % Number of poles: 2 Enclosure class (IEC 34-5): IP55 Insulation class (IEC 85): F Motor No: 98943382 Bearing insulation type N-end: STEEL BEARING</p> <p>Others:</p> <p>Minimum efficiency index, MEI ≥: 0.70 Net weight: 1290 kg Gross weight: 1390 kg Shipping volume: 2.97 m³ Country of origin: HU Custom tariff no.: 84137059</p>

98973181 NK 100-250/258 BA2F2AESBQQE1W1 50 Hz

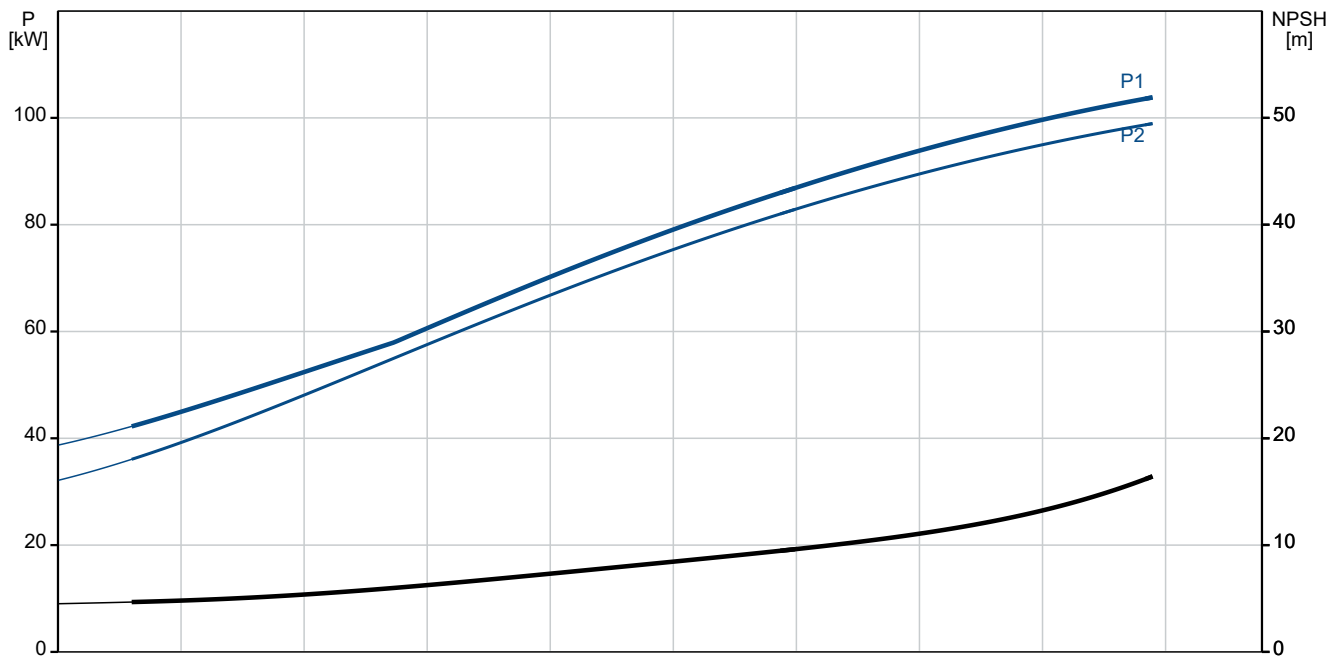
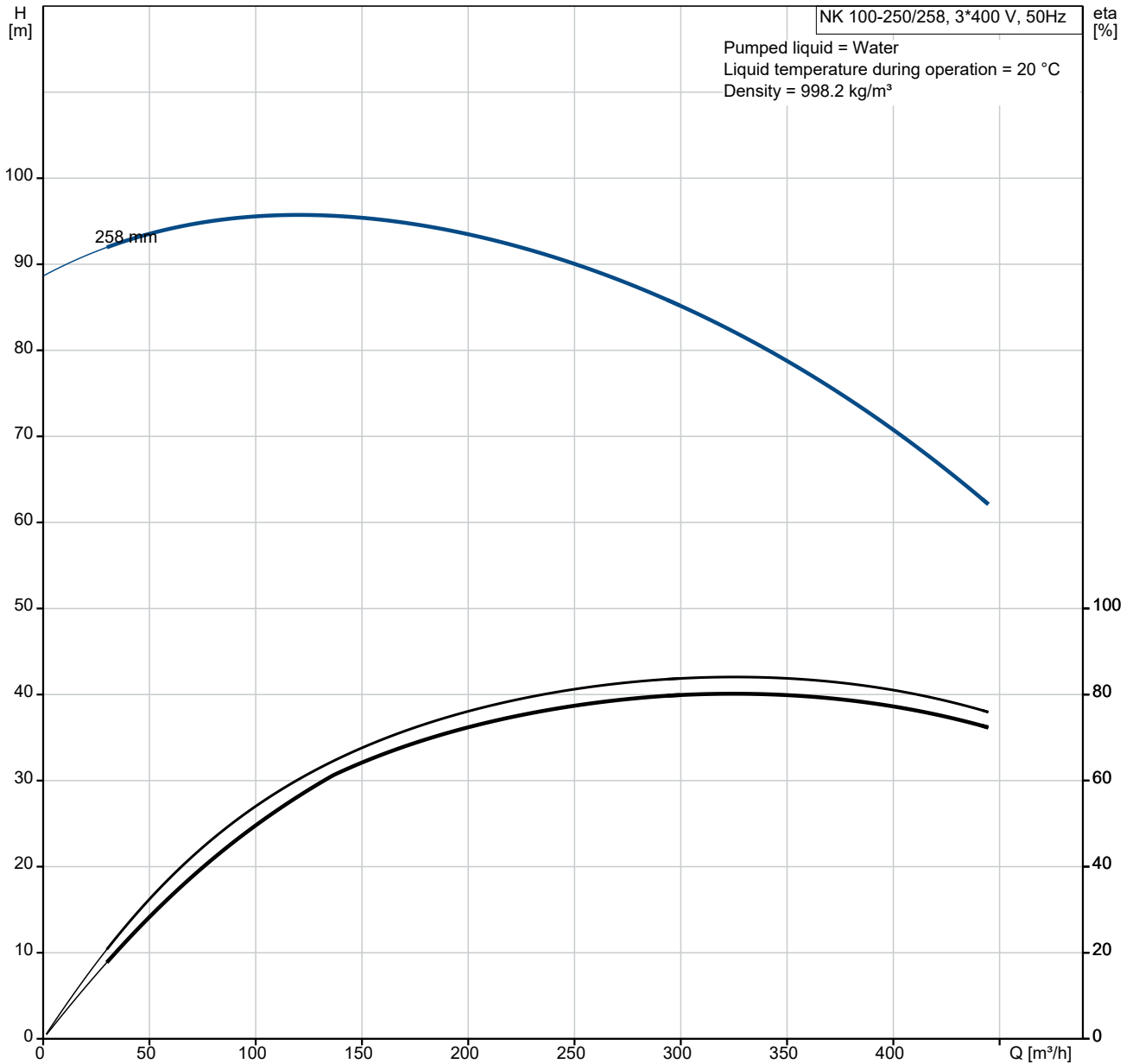

Description	Value
General information:	
Product name:	NK 100-250/258 BA2F2AESBQQE1W1
Product No:	98973181
EAN number:	5712604500217
Technical:	
Pump speed on which pump data are based:	2982 rpm
Rated flow:	324.6 m ³ /h
Pump with motor (Yes/No):	Y
Rated head:	81.94 m
Actual impeller diameter:	258 mm
Nominal impeller diameter:	250
Shaft diameter:	32 mm
Code for shaft seal:	BQQE
Mechanical seal type:	Single
Curve tolerance:	ISO9906:2012 3B
Pump version:	A2
Bearing design:	Standard
Materials:	
Pump housing:	Cast iron
Pump housing:	EN-GJL-250
Pump housing:	ASTM class 35
Wear ring:	Brass
Impeller:	Cast iron
Impeller:	EN-GJL-200
Impeller:	ASTM class 30
Internal pump house coating:	CED
Material code:	A
Code for rubber:	E
Shaft:	Stainless steel
Shaft:	EN 1.4301
Shaft:	AISI 304
Installation:	
t max amb:	55 °C
Maximum operating pressure:	16 bar
Pipe connection standard:	EN 1092-2
Type of inlet connection:	DIN
Type of outlet connection:	DIN
Size of inlet connection:	DN 125
Size of outlet connection:	DN 100
Pressure rating for connection:	PN 16
Coupling type:	Flexible w/spacer
Base frame design:	EN/ISO
Code for base frame:	10
Grouting (Yes/No):	Y
Connect code:	F
Liquid:	
Pumped liquid:	Water
Liquid temperature range:	-25 .. 120 °C
Selected liquid temperature:	20 °C
Density:	998.2 kg/m ³
Electrical data:	
Motor type:	SIEMENS
IE Efficiency class:	IE3
Rated power - P2:	110 kW
Mains frequency:	50 Hz
Rated voltage:	3 x 380-420D/660-725Y V
Rated current:	183/106 A
Starting current:	710-710 %
Cos phi - power factor:	0.91
Rated speed:	2982 rpm
Efficiency:	IE3 95,2%
Motor efficiency at full load:	95.2-95.2 %

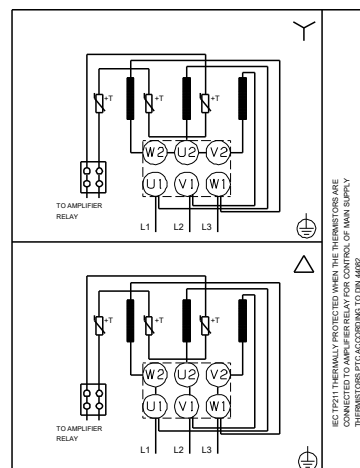
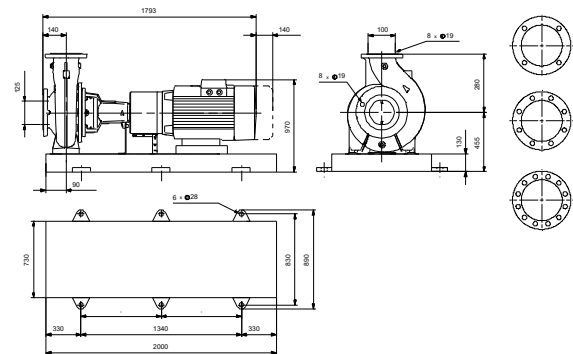
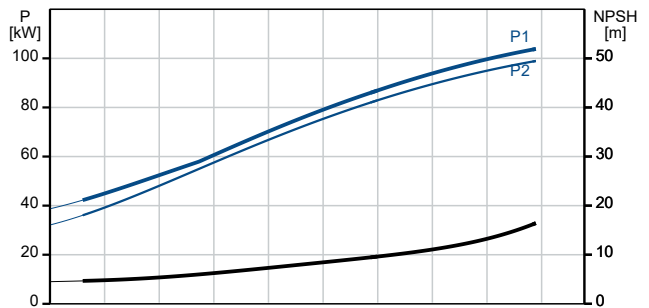
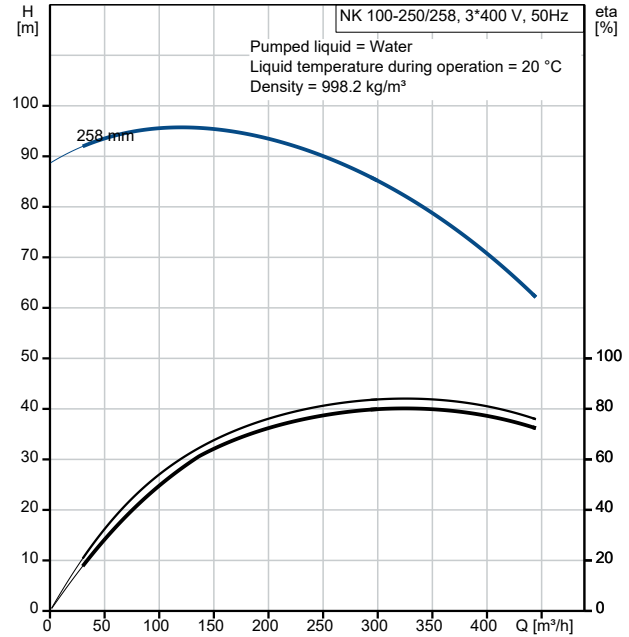

Description	Value
Motor efficiency at 3/4 load:	95.4-95.4 %
Motor efficiency at 1/2 load:	94.9-94.9 %
Number of poles:	2
Enclosure class (IEC 34-5):	IP55
Insulation class (IEC 85):	F
Built-in motor protection:	PTC
Motor No:	98943382
Bearing insulation type N-end:	STEEL BEARING
Controls:	
Frequency converter:	NONE
Pressure sensor:	N
Others:	
Minimum efficiency index, MEI ≥:	0.70
Net weight:	1290 kg
Gross weight:	1390 kg
Shipping volume:	2.97 m ³
Country of origin:	HU
Custom tariff no.:	84137059

98973181 NK 100-250/258 BA2F2AESBQQE1W1 50 Hz



IEC TP211 THERMALLY PROTECTED WHEN THE THERMISTORS ARE
CONNECTED TO AMPLIFIER RELAY FOR CONTROL OF MAIN SUPPLY
THERMISTORS PTC ACCORDING TO DIN 44082

Note! All units are in [mm] unless others are stated.

