

Qty. Description1 **NBE 40-125/105 AAF2AESBQQEHWB****Note! Product picture may differ from actual product**Product No.: [98602651](#)

Non-self-priming, single-stage, centrifugal volute pump designed according to ISO 5199 with dimensions and rated performance according to EN 733 (10 bar).

Flanges are PN 16 with dimensions according to EN 1092-2. The pump has an axial suction port, radial discharge port, horizontal shaft and a back pull-out design enabling removal of the motor, motor stool, cover and impeller without disturbing the pump housing or pipework.

The unbalanced rubber bellows seal is according to DIN EN 12756.

The pump is close-coupled to a fan-cooled, permanent-magnet synchronous motor.

The motor includes a frequency converter and PI controller in the motor terminal box. This enables continuously variable control of the motor speed, which again enables adaptation of the performance to a given requirement.

Controls:

Frequency converter: Built-in

Pressure sensor: N

Liquid:

Pumped liquid: Water

Liquid temperature range: -25 .. 120 °C

Selected liquid temperature: 20 °C

Density: 998.2 kg/m³**Technical:**

Pump speed on which pump data are based: 2901 rpm

Rated flow: 37.21 m³/h

Rated head: 10.01 m

Actual impeller diameter: 105 mm

Nominal impeller diameter: 125

Shaft seal arrangement: Single

Code for shaft seal: BQQE

Curve tolerance: ISO9906:2012 3B2

Bearing design: Standard

Materials:Pump housing: Cast iron
EN-GJL-250
ASTM class 35

Wear ring: Brass

Impeller: Cast iron
EN-GJL-200
ASTM class 30

Internal pump house coating: CED

Shaft: Stainless steel
EN 1.4301
AISI 304**Installation:**

Range of ambient temperature: -20 .. 50 °C

Maximum operating pressure: 16 bar

Pipe connection standard: EN 1092-2

Size of inlet connection: DN 65

Size of outlet connection: DN 40

Pressure rating for connection: PN 16

Qty.	Description																																																				
1	<table border="0"> <tr> <td>Bearing lubrication:</td> <td>Grease</td> </tr> <tr> <td>Pump housing with feet:</td> <td>Yes</td> </tr> <tr> <td>Support block (Yes/No):</td> <td>N</td> </tr> <tr> <td colspan="2">Electrical data:</td> </tr> <tr> <td>IE Efficiency class:</td> <td>IE5</td> </tr> <tr> <td>Rated power - P2:</td> <td>1.5 kW</td> </tr> <tr> <td>Mains frequency:</td> <td>50 Hz</td> </tr> <tr> <td>Rated voltage:</td> <td>3 x 380-500 V</td> </tr> <tr> <td>Rated current:</td> <td>2.90-2.40 A</td> </tr> <tr> <td>Cos phi - power factor:</td> <td>0.92-0.85</td> </tr> <tr> <td>Rated speed:</td> <td>360-4000 rpm</td> </tr> <tr> <td>Efficiency:</td> <td>88.9%</td> </tr> <tr> <td>Motor efficiency at full load:</td> <td>88.9 %</td> </tr> <tr> <td>Number of poles:</td> <td>2</td> </tr> <tr> <td>Enclosure class (IEC 34-5):</td> <td>IP55</td> </tr> <tr> <td>Insulation class (IEC 85):</td> <td>F</td> </tr> <tr> <td>Motor No:</td> <td>98726491</td> </tr> <tr> <td>Bearing insulation type N-end:</td> <td>STEEL BEARING</td> </tr> <tr> <td colspan="2">Others:</td> </tr> <tr> <td>Minimum efficiency index, MEI ≥:</td> <td>0.70</td> </tr> <tr> <td>Net weight:</td> <td>41 kg</td> </tr> <tr> <td>Gross weight:</td> <td>51 kg</td> </tr> <tr> <td>Shipping volume:</td> <td>0.134 m³</td> </tr> <tr> <td>Danish VVS No.:</td> <td>386101126</td> </tr> <tr> <td>Country of origin:</td> <td>HU</td> </tr> <tr> <td>Custom tariff no.:</td> <td>84137051</td> </tr> </table>	Bearing lubrication:	Grease	Pump housing with feet:	Yes	Support block (Yes/No):	N	Electrical data:		IE Efficiency class:	IE5	Rated power - P2:	1.5 kW	Mains frequency:	50 Hz	Rated voltage:	3 x 380-500 V	Rated current:	2.90-2.40 A	Cos phi - power factor:	0.92-0.85	Rated speed:	360-4000 rpm	Efficiency:	88.9%	Motor efficiency at full load:	88.9 %	Number of poles:	2	Enclosure class (IEC 34-5):	IP55	Insulation class (IEC 85):	F	Motor No:	98726491	Bearing insulation type N-end:	STEEL BEARING	Others:		Minimum efficiency index, MEI ≥:	0.70	Net weight:	41 kg	Gross weight:	51 kg	Shipping volume:	0.134 m ³	Danish VVS No.:	386101126	Country of origin:	HU	Custom tariff no.:	84137051
Bearing lubrication:	Grease																																																				
Pump housing with feet:	Yes																																																				
Support block (Yes/No):	N																																																				
Electrical data:																																																					
IE Efficiency class:	IE5																																																				
Rated power - P2:	1.5 kW																																																				
Mains frequency:	50 Hz																																																				
Rated voltage:	3 x 380-500 V																																																				
Rated current:	2.90-2.40 A																																																				
Cos phi - power factor:	0.92-0.85																																																				
Rated speed:	360-4000 rpm																																																				
Efficiency:	88.9%																																																				
Motor efficiency at full load:	88.9 %																																																				
Number of poles:	2																																																				
Enclosure class (IEC 34-5):	IP55																																																				
Insulation class (IEC 85):	F																																																				
Motor No:	98726491																																																				
Bearing insulation type N-end:	STEEL BEARING																																																				
Others:																																																					
Minimum efficiency index, MEI ≥:	0.70																																																				
Net weight:	41 kg																																																				
Gross weight:	51 kg																																																				
Shipping volume:	0.134 m ³																																																				
Danish VVS No.:	386101126																																																				
Country of origin:	HU																																																				
Custom tariff no.:	84137051																																																				

98602651 NBE 40-125/105 AAF2AESBQQEHWB 50 Hz

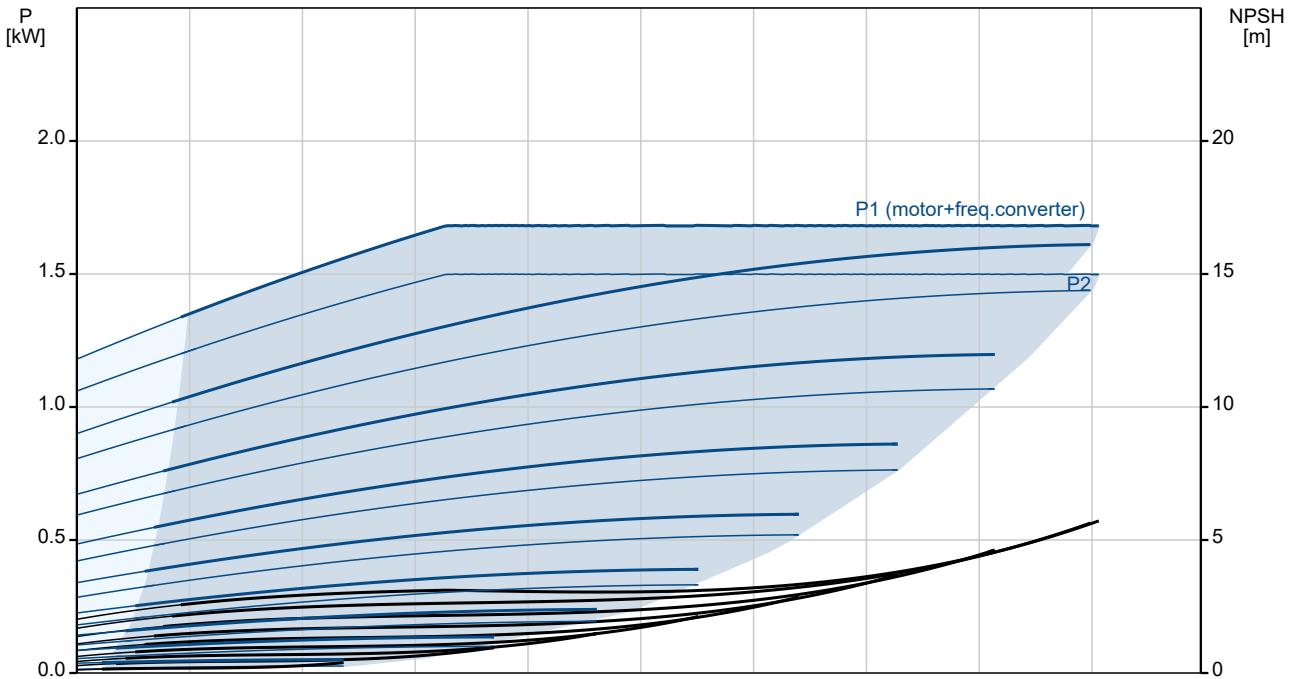
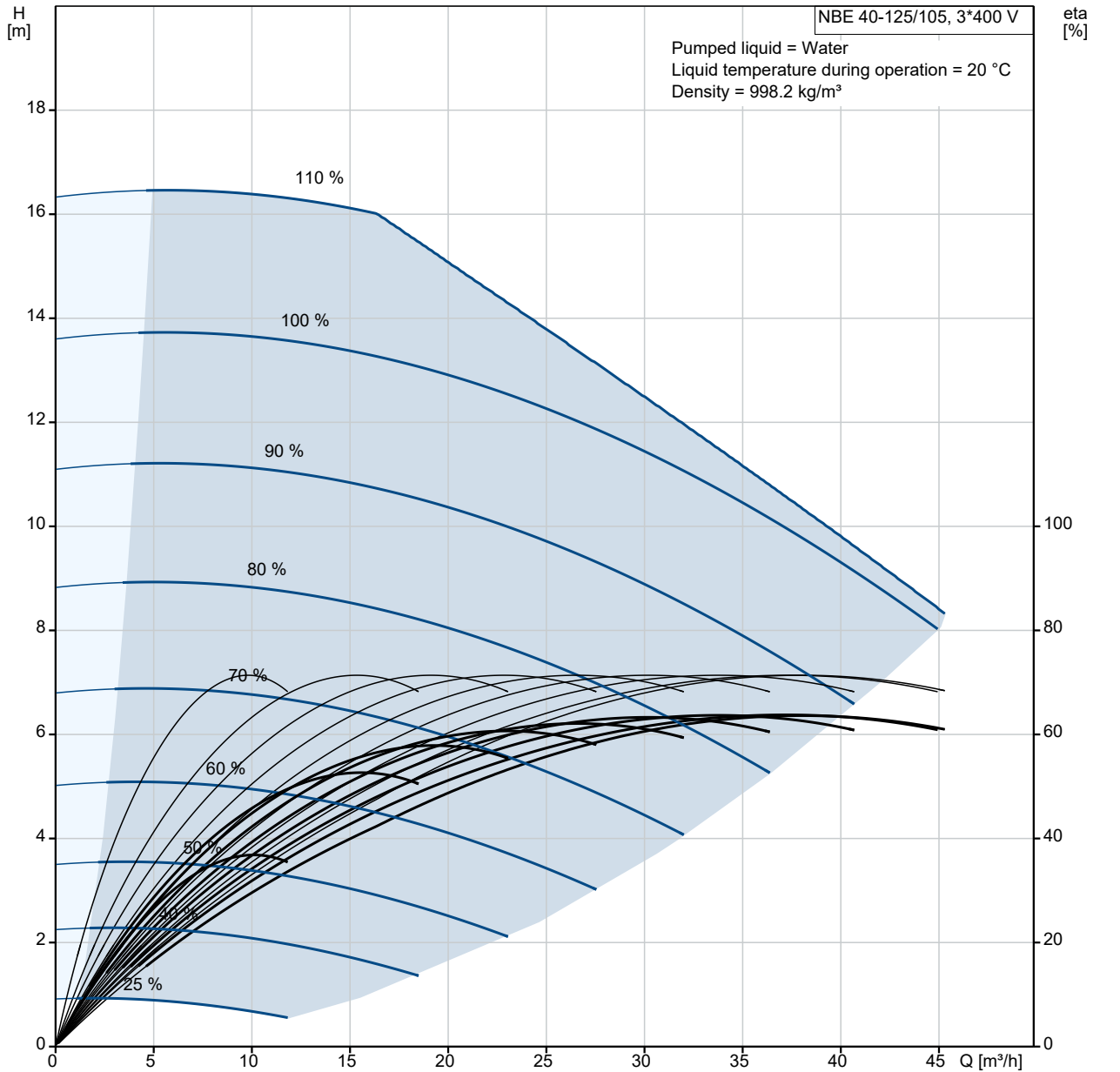

Description	Value
General information:	
Product name:	NBE 40-125/105 AAF2AESBQQEHWB
Product No:	98602651
EAN number:	5711498030862
Technical:	
Pump speed on which pump data are based:	2901 rpm
Rated flow:	37.21 m ³ /h
Rated head:	10.01 m
Actual impeller diameter:	105 mm
Nominal impeller diameter:	125
Shaft seal arrangement:	Single
Shaft diameter:	24 mm
Code for shaft seal:	BQQE
Curve tolerance:	ISO9906:2012 3B2
Pump version:	A
Bearing design:	Standard
Materials:	
Pump housing:	Cast iron
Pump housing:	EN-GJL-250
Pump housing:	ASTM class 35
Wear ring:	Brass
Impeller:	Cast iron
Impeller:	EN-GJL-200
Impeller:	ASTM class 30
Internal pump house coating:	CED
Material code:	A
Code for rubber:	E
Shaft:	Stainless steel
Shaft:	EN 1.4301
Shaft:	AISI 304
Installation:	
Range of ambient temperature:	-20 .. 50 °C
Maximum operating pressure:	16 bar
Pipe connection standard:	EN 1092-2
Size of inlet connection:	DN 65
Size of outlet connection:	DN 40
Pressure rating for connection:	PN 16
Bearing lubrication:	Grease
Pump housing with feet:	Yes
Support block (Yes/No):	N
Connect code:	F2
Liquid:	
Pumped liquid:	Water
Liquid temperature range:	-25 .. 120 °C
Selected liquid temperature:	20 °C
Density:	998.2 kg/m ³
Electrical data:	
IE Efficiency class:	IE5
Rated power - P2:	1.5 kW
Mains frequency:	50 Hz
Rated voltage:	3 x 380-500 V
Rated current:	2.90-2.40 A
Cos phi - power factor:	0.92-0.85
Rated speed:	360-4000 rpm
Efficiency:	88.9%
Motor efficiency at full load:	88.9 %
Number of poles:	2
Enclosure class (IEC 34-5):	IP55
Insulation class (IEC 85):	F
Built-in motor protection:	ELEC
Motor No:	98726491
Mount. design. acc. IEC 34-7:	IM V1/B5

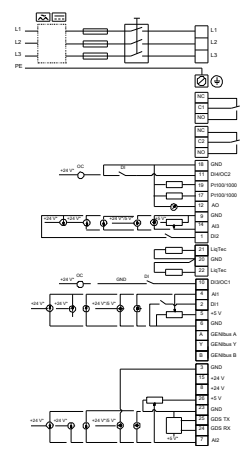
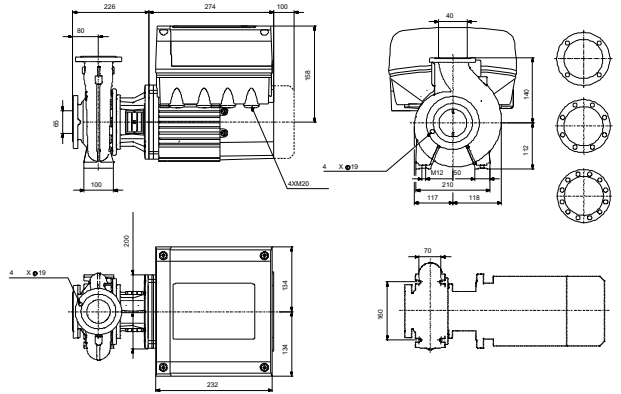
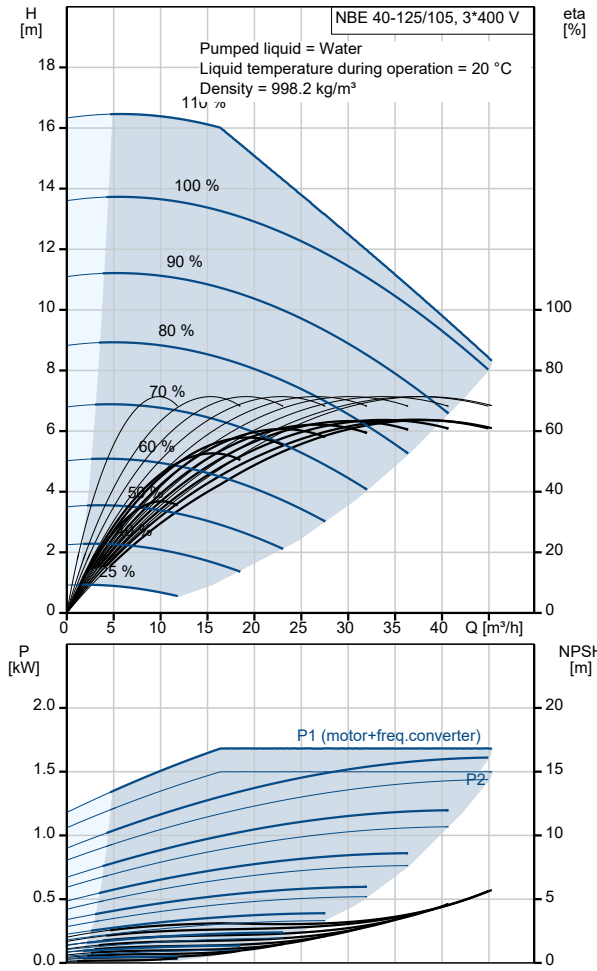

Description	Value
Bearing insulation type N-end:	STEEL BEARING
Controls:	
Control panel:	HMI300 - Graphical
Function Module:	FM300 - Advanced
Frequency converter:	Built-in
Pressure sensor:	N
Others:	
Minimum efficiency index, MEI ≥:	0.70
Net weight:	41 kg
Gross weight:	51 kg
Shipping volume:	0.134 m ³
Danish VVS No.:	386101126
Country of origin:	HU
Custom tariff no.:	84137051

98602651 NBE 40-125/105 AAF2AESBQQEHWB 50 Hz

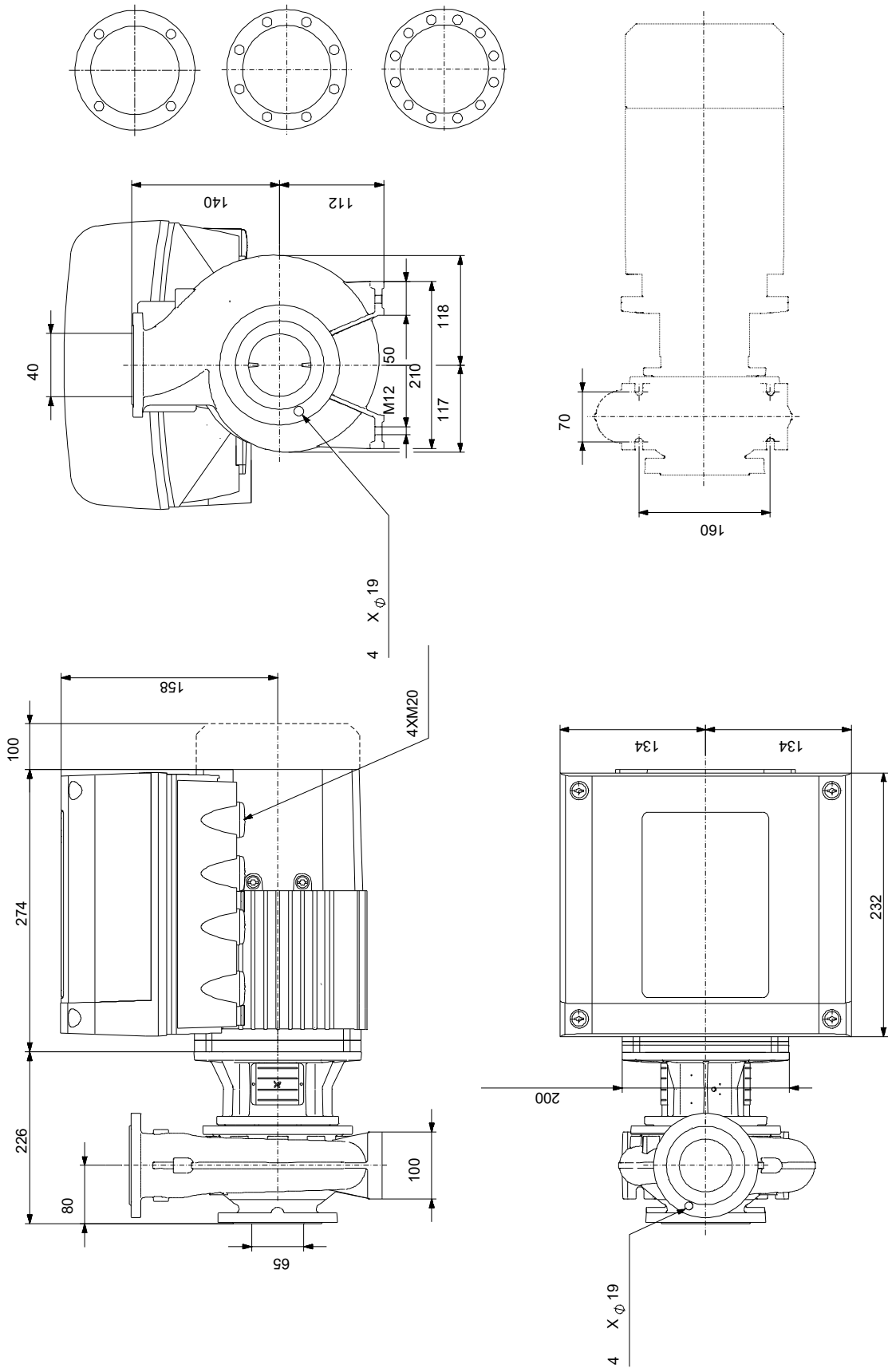

Note! All units are in [mm] unless others are stated.
 Disclaimer: This simplified dimensional drawing does not show all details.

98602651 NBE 40-125/105 AAF2AESBQQEHWB 50 Hz

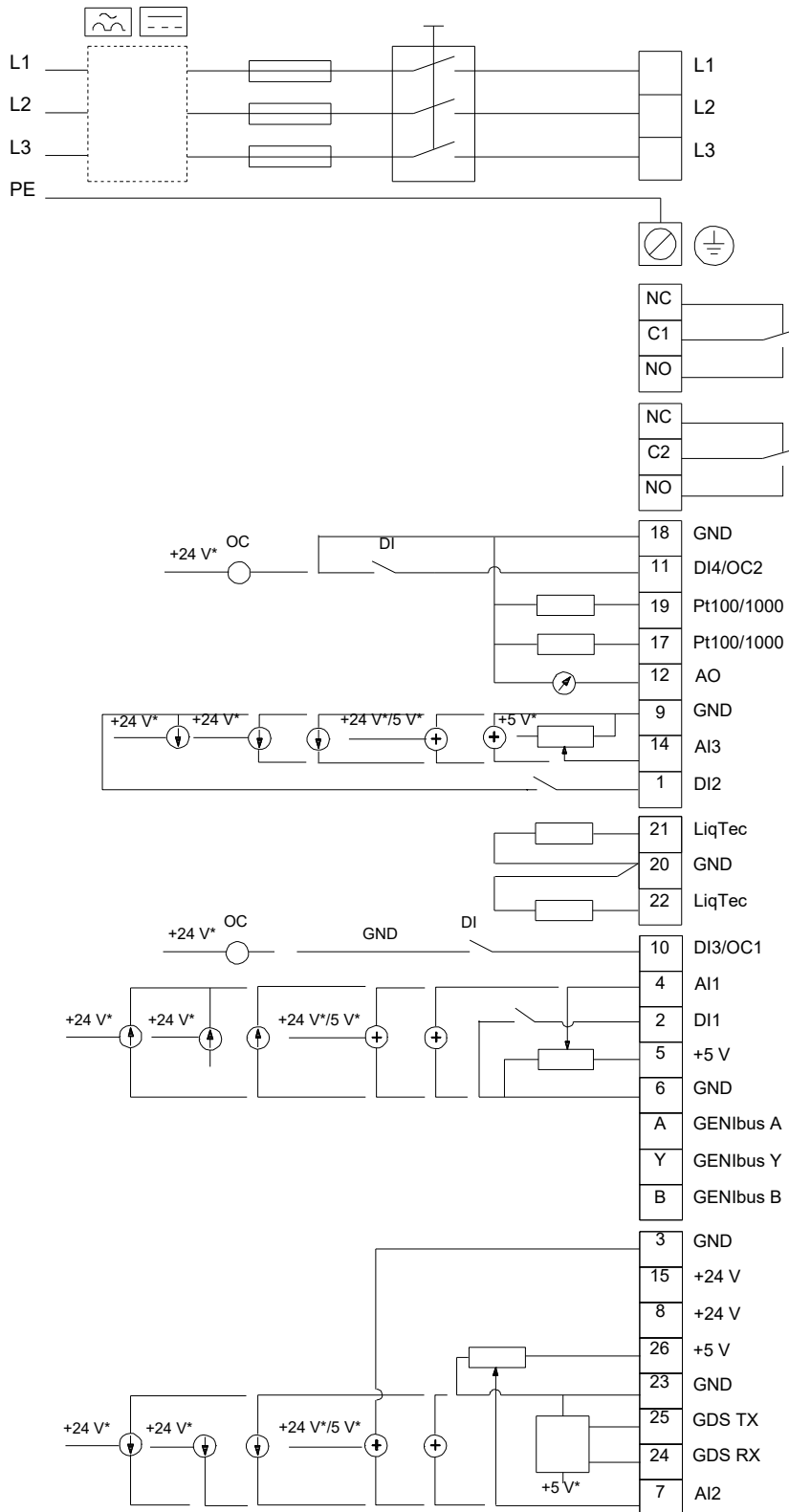

Note! All units are in [mm] unless others are stated.

