

Qty.	Description
1	<p data-bbox="204 163 517 185"><b>MTR 1S-25/25 A-W-A-HUUV</b></p>  <p data-bbox="204 483 478 506">Product No.: On request</p> <p data-bbox="204 544 1430 618">Multistage, immersible, self-priming, centrifugal pump for vertical installation in tanks etc. The pump head and base are in cast iron – all other wetted parts are in stainless steel. The pump has the following characteristics:</p> <ul data-bbox="240 629 1115 741" style="list-style-type: none"> <li>• Dimensions according to DIN 5440.</li> <li>• Impellers, intermediate chambers and spline shaft are made of Stainless steel.</li> <li>• Mechanical shaft seal according to EN 12756.</li> <li>• Power transmission via sintered metal split coupling.</li> </ul> <p data-bbox="204 748 1430 797">A cartridge shaft seal ensures high reliability, safe handling, and easy access and service. The pump is fitted with a 3-phase, fan-cooled asynchronous motor.</p> <p data-bbox="204 835 300 857">Controls:</p> <p data-bbox="204 864 636 887">Frequency converter: NONE</p> <p data-bbox="204 925 276 947">Liquid:</p> <p data-bbox="204 954 632 976">Pumped liquid: Water</p> <p data-bbox="204 983 691 1005">Liquid temperature range: -10 .. 90 °C</p> <p data-bbox="204 1012 632 1034">Selected liquid temperature: 20 °C</p> <p data-bbox="204 1041 695 1064">Density: 998.2 kg/m<sup>3</sup></p> <p data-bbox="204 1102 316 1124">Technical:</p> <p data-bbox="204 1131 818 1153">Pump speed on which pump data are based: 2864 rpm</p> <p data-bbox="204 1160 652 1182">Rated flow: 15 l/min</p> <p data-bbox="204 1189 643 1211">Rated head: 97.3 m</p> <p data-bbox="204 1218 595 1240">Chambers: 25</p> <p data-bbox="204 1247 584 1270">Drainage back to tank: N</p> <p data-bbox="204 1276 647 1299">Pump orientation: Vertical</p> <p data-bbox="204 1305 636 1328">Code for shaft seal: HUUV</p> <p data-bbox="204 1335 659 1357">Approvals: CE,EAC</p> <p data-bbox="204 1364 759 1386">Curve tolerance: ISO9906:2012 3B</p> <p data-bbox="204 1424 309 1447">Materials:</p> <p data-bbox="204 1453 802 1543">Pump head: Cast iron EN 1561 EN-GJL-200 ASTM A48-25B</p> <p data-bbox="204 1550 724 1639">Impeller: Stainless steel EN 1.4301 AISI 304</p> <p data-bbox="204 1664 328 1686">Installation:</p> <p data-bbox="204 1693 628 1715">t max amb: 60 °C</p> <p data-bbox="204 1722 638 1744">Maximum operating pressure: 25 bar</p> <p data-bbox="204 1751 718 1774">Max pressure at stated temp: 25 bar / 90 °C</p> <p data-bbox="204 1780 748 1803">Type of connection: G internal thread</p> <p data-bbox="204 1809 673 1832">Size of outlet connection: 1 1/4 inch</p> <p data-bbox="204 1839 655 1861">Immersion depth: 574 mm</p> <p data-bbox="204 1868 638 1890">Flange size for motor: FT100</p> <p data-bbox="204 1928 363 1951">Electrical data:</p> <p data-bbox="204 1957 608 1980">Motor standard: IEC</p> <p data-bbox="204 1986 612 2009">Motor type: 80A</p> <p data-bbox="204 2016 604 2038">IE Efficiency class: IE3</p> <p data-bbox="204 2045 655 2067">Rated power - P2: 0.75 kW</p>

Qty.	Description																																																
1	<table> <tr> <td>Mains frequency:</td> <td>50 Hz</td> </tr> <tr> <td>Suitable for 50/60 Hz:</td> <td>N</td> </tr> <tr> <td>Rated voltage:</td> <td>3 x 220-240D/380-415Y V</td> </tr> <tr> <td>Rated current:</td> <td>3.30/1.90 A</td> </tr> <tr> <td>Starting current:</td> <td>580-620 %</td> </tr> <tr> <td>Cos phi - power factor:</td> <td>0.81-0.71</td> </tr> <tr> <td>Rated speed:</td> <td>2840-2870 rpm</td> </tr> <tr> <td>Efficiency:</td> <td>IE3 80,7%</td> </tr> <tr> <td>Motor efficiency at full load:</td> <td>80.7 %</td> </tr> <tr> <td>Motor efficiency at 3/4 load:</td> <td>82.7 %</td> </tr> <tr> <td>Motor efficiency at 1/2 load:</td> <td>81.7 %</td> </tr> <tr> <td>Number of poles:</td> <td>2</td> </tr> <tr> <td>Enclosure class (IEC 34-5):</td> <td>55 Dust/Jetting</td> </tr> <tr> <td>Insulation class (IEC 85):</td> <td>F</td> </tr> <tr> <td>Motor No:</td> <td>85U05104</td> </tr> <tr> <td colspan="2">Others:</td> </tr> <tr> <td>Terminal box position:</td> <td>6</td> </tr> <tr> <td>Minimum efficiency index, MEI ≥:</td> <td>0.67</td> </tr> <tr> <td>Net weight:</td> <td>15.2 kg</td> </tr> <tr> <td>Gross weight:</td> <td>19.2 kg</td> </tr> <tr> <td>Shipping volume:</td> <td>0.097 m<sup>3</sup></td> </tr> <tr> <td>Danish VVS No.:</td> <td>386960025</td> </tr> <tr> <td>Country of origin:</td> <td>HU</td> </tr> <tr> <td>Custom tariff no.:</td> <td>84137075</td> </tr> </table>	Mains frequency:	50 Hz	Suitable for 50/60 Hz:	N	Rated voltage:	3 x 220-240D/380-415Y V	Rated current:	3.30/1.90 A	Starting current:	580-620 %	Cos phi - power factor:	0.81-0.71	Rated speed:	2840-2870 rpm	Efficiency:	IE3 80,7%	Motor efficiency at full load:	80.7 %	Motor efficiency at 3/4 load:	82.7 %	Motor efficiency at 1/2 load:	81.7 %	Number of poles:	2	Enclosure class (IEC 34-5):	55 Dust/Jetting	Insulation class (IEC 85):	F	Motor No:	85U05104	Others:		Terminal box position:	6	Minimum efficiency index, MEI ≥:	0.67	Net weight:	15.2 kg	Gross weight:	19.2 kg	Shipping volume:	0.097 m <sup>3</sup>	Danish VVS No.:	386960025	Country of origin:	HU	Custom tariff no.:	84137075
Mains frequency:	50 Hz																																																
Suitable for 50/60 Hz:	N																																																
Rated voltage:	3 x 220-240D/380-415Y V																																																
Rated current:	3.30/1.90 A																																																
Starting current:	580-620 %																																																
Cos phi - power factor:	0.81-0.71																																																
Rated speed:	2840-2870 rpm																																																
Efficiency:	IE3 80,7%																																																
Motor efficiency at full load:	80.7 %																																																
Motor efficiency at 3/4 load:	82.7 %																																																
Motor efficiency at 1/2 load:	81.7 %																																																
Number of poles:	2																																																
Enclosure class (IEC 34-5):	55 Dust/Jetting																																																
Insulation class (IEC 85):	F																																																
Motor No:	85U05104																																																
Others:																																																	
Terminal box position:	6																																																
Minimum efficiency index, MEI ≥:	0.67																																																
Net weight:	15.2 kg																																																
Gross weight:	19.2 kg																																																
Shipping volume:	0.097 m <sup>3</sup>																																																
Danish VVS No.:	386960025																																																
Country of origin:	HU																																																
Custom tariff no.:	84137075																																																

# On request MTR 1S-25/25 A-W-A-HUUV 50 Hz

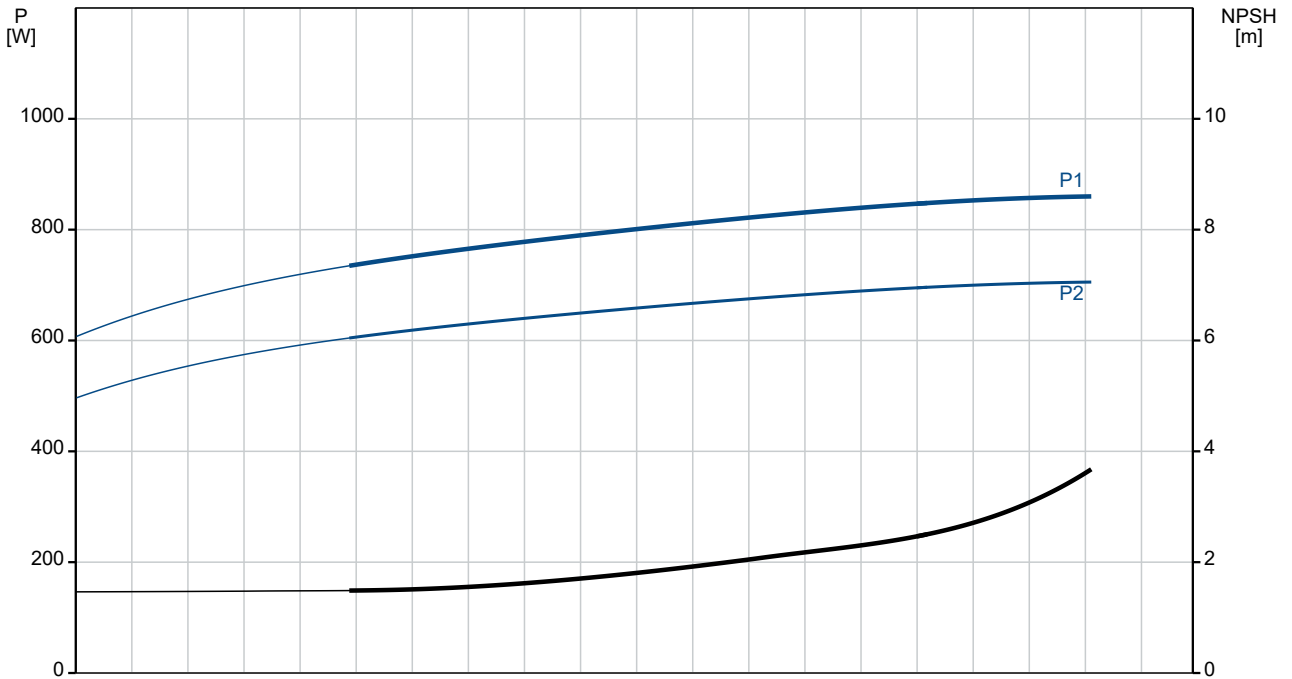
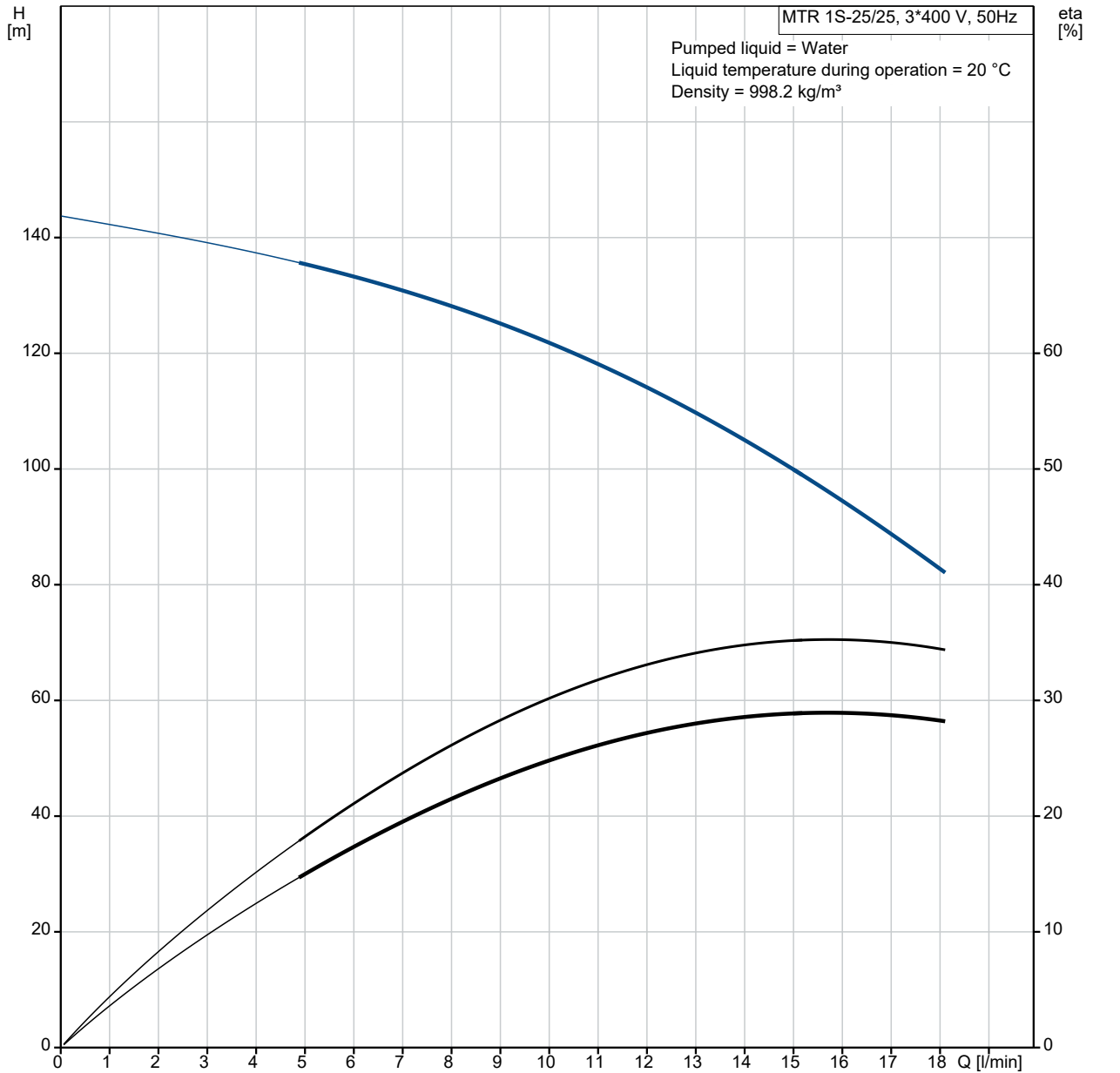

Description	Value
<b>General information:</b>	
Product name:	MTR 1S-25/25 A-W-A-HUUV
Product No:	On request
EAN number:	On request
<b>Technical:</b>	
Pump speed on which pump data are based:	2864 rpm
Rated flow:	15 l/min
Rated head:	97.3 m
Chambers:	25
Impellers:	25
Number of reduced-diameter impellers:	0
Drainage back to tank:	N
Pump orientation:	Vertical
Code for shaft seal:	HUUV
Approvals:	CE,EAC
Curve tolerance:	ISO9906:2012 3B
Pump version:	A
Model:	A
<b>Materials:</b>	
Pump head:	Cast iron
Pump head:	EN 1561 EN-GJL-200
Pump head:	ASTM A48-25B
Impeller:	Stainless steel
Impeller:	EN 1.4301
Impeller:	AISI 304
Material code:	A
<b>Installation:</b>	
t max amb:	60 °C
Maximum operating pressure:	25 bar
Max pressure at stated temp:	25 bar / 90 °C
Type of connection:	G internal thread
Size of outlet connection:	1 1/4 inch
Immersion depth:	574 mm
Flange size for motor:	FT100
Connect code:	W
<b>Liquid:</b>	
Pumped liquid:	Water
Liquid temperature range:	-10 .. 90 °C
Selected liquid temperature:	20 °C
Density:	998.2 kg/m <sup>3</sup>
<b>Electrical data:</b>	
Motor standard:	IEC
Motor type:	80A
IE Efficiency class:	IE3
Rated power - P2:	0.75 kW
Mains frequency:	50 Hz
Suitable for 50/60 Hz:	N
Rated voltage:	3 x 220-240D/380-415Y V
Rated current:	3.30/1.90 A
Starting current:	580-620 %
Cos phi - power factor:	0.81-0.71
Rated speed:	2840-2870 rpm
Efficiency:	IE3 80,7%
Motor efficiency at full load:	80.7 %
Motor efficiency at 3/4 load:	82.7 %
Motor efficiency at 1/2 load:	81.7 %
Number of poles:	2
Enclosure class (IEC 34-5):	55 Dust/Jetting
Insulation class (IEC 85):	F
Built-in motor protection:	NONE
Motor No:	85U05104
<b>Controls:</b>	

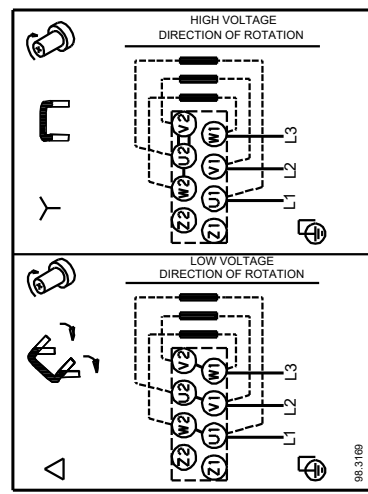
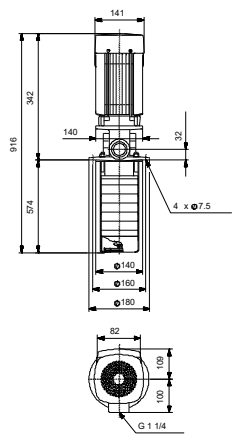
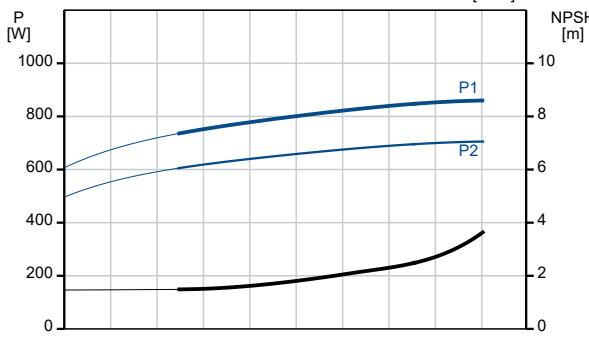
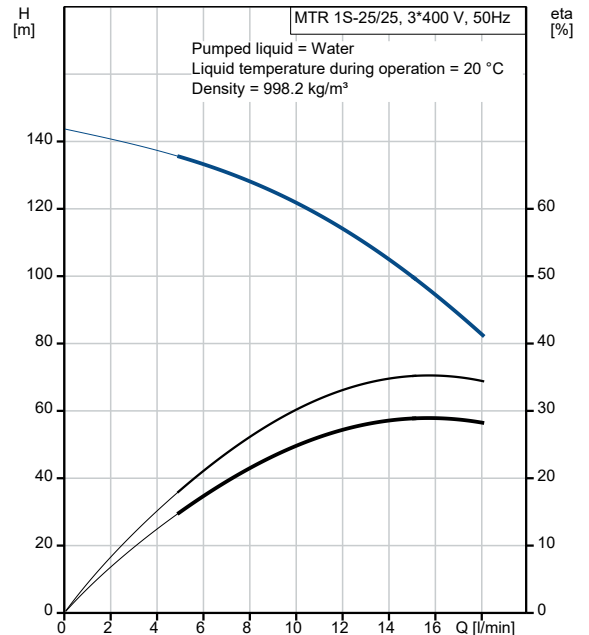

Description	Value
Frequency converter:	NONE
<b>Others:</b>	
Terminal box position:	6
Minimum efficiency index, MEI ≥:	0.67
Net weight:	15.2 kg
Gross weight:	19.2 kg
Shipping volume:	0.097 m <sup>3</sup>
Danish VVS No.:	386960025
Country of origin:	HU
Custom tariff no.:	84137075

# On request MTR 1S-25/25 A-W-A-HUUV 50 Hz

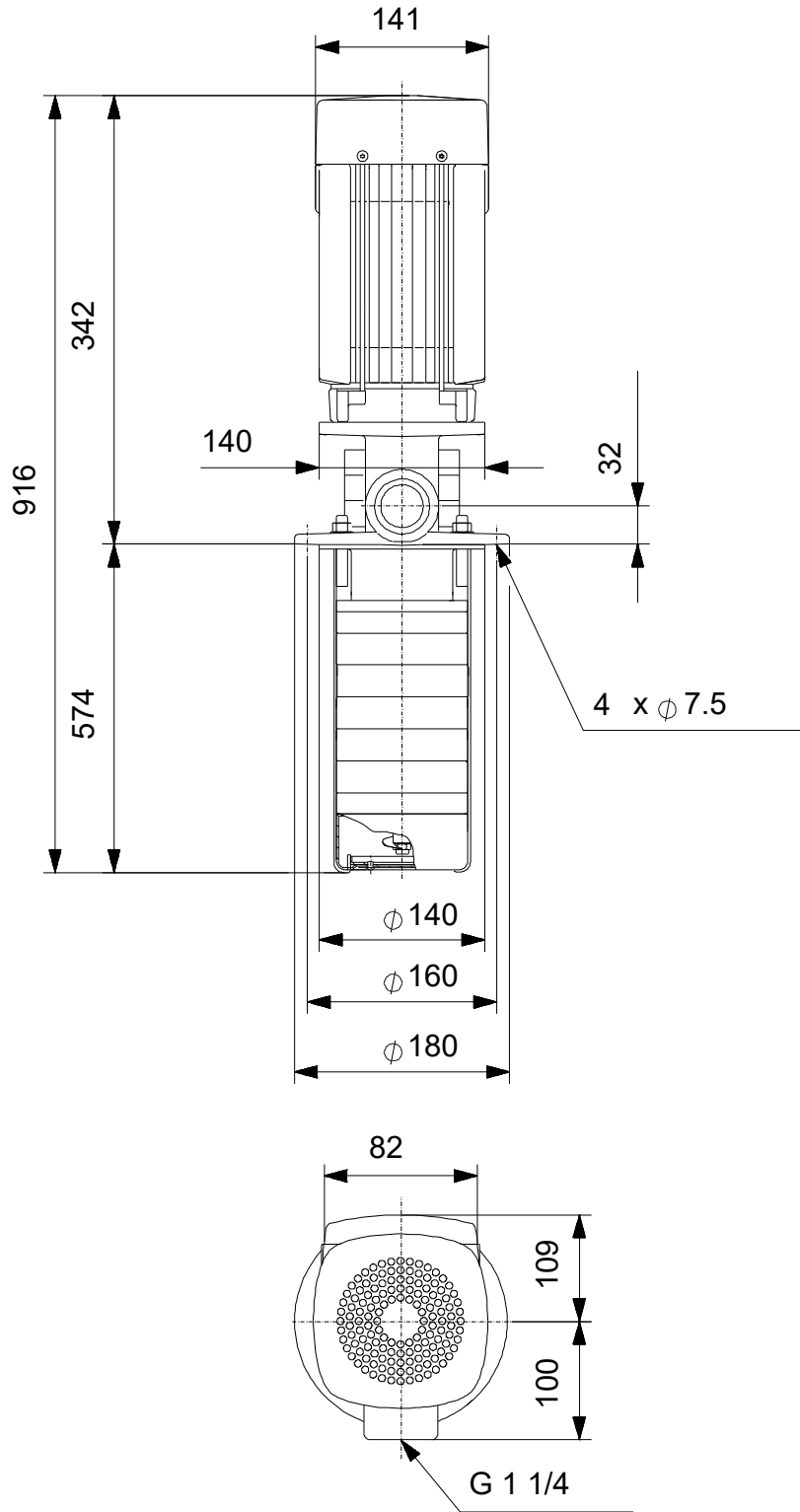

Note! All units are in [mm] unless others are stated.  
Disclaimer: This simplified dimensional drawing does not show all details.

On request MTR 1S-25/25 A-W-A-HUUV 50 Hz



98.3169

Note! All units are in [mm] unless others are stated.

