

Qty. Description

1 Hydro MPC-E 4 CRE 45-3



Note! Product picture may differ from actual product

Product No.: [98427055](#)

Pressure booster system supplied as compact assembly according to DIN standard 1988/T5.

All pumps are speed-controlled.

From 0.37 to 11 kW, the booster system is equipped with CR, CRE, CRI, CRIE pumps with electronically commutated permanent-magnet motors with extremely high efficiency. The total efficiency of the motor including the frequency converter applies to IE5 level in IEC60034-31.

From 15 to 22 kW, the booster system is equipped with CR, CRE, CRI, CRIE pumps with motors with integrated frequency control. The total efficiency of the motor including the frequency converter is better than the IE3 level in IEC60034-31, even though this standard only applies to the motor.

- * Hydro MPC-E maintains a constant pressure through continuous adjustment of the speed of the pumps.
- * The system performance is adapted to the demand through cutting in/out the required number of pumps and through parallel control of the pumps in operation.
- * Pump changeover is automatic and depends on load, time and fault.

The system consists of these parts:

:vertical, multistage, centrifugal pumps, type CRE 45-3

Pump parts in contact with the pumped liquid are made of stainless steel EN DIN 1.4301

Pump bases and heads are of either cast iron/stainless steel (CRI) or cast iron EN-GJS-500-7 (CR), depending on pump type; other vital parts are made of stainless steel EN DIN 1.4301

The pumps are equipped with a service-friendly cartridge shaft seal, HQQE (SiC/SiC/EPDM)

- * Two stainless steel manifolds to EN DIN 1.4571
- * Stainless steel base frame to EN DIN 1.4301 up to CR 90; above CR 90 the pumps are placed on a galvanized I-Beam frame
- * One non-return valve (POM) and two isolating valves for each pump
- * Non-return valves are certified according to DVGW, isolating valves according to DIN and DVGW
- * Adapter with isolating valve for connection of diaphragm tank
- * Pressure gauge and pressure transmitter (analog output 4-20 mA)
- * Control MPC in a steel cabinet, IP54, including main switch, all required fuses, motor protection, switching equipment and microprocessor-controlled CU 352.

Dry-running protection and diaphragm tank are available according to the list of accessories.

Pump operation is controlled by Control MPC with the following functions:

- * Intelligent multipump controller, CU 352.
Constant-pressure control through continuously variable adjustment of the speed of each individual pump.
PID controller with adjustable PI parameters (Kp + Ti).
Constant pressure at setpoint, independent of inlet pressure.
Soft pressure build-up (To prevent water hammer during startup).
On/off operation at low flow.
Automatic cascade control of pumps for optimum efficiency.
Selection of min. time between start/stop, automatic pump changeover and pump

Qty.	Description																
1	<p>Automatic pump test function to prevent idle pumps from seizing up. Possibility of standby pump allocation. Possibility of backup sensor (redundant primary sensor). Secondary sensor (Possible to switch to another sensor/setpoint). Multi-sensor (up to 6 sensors to influence the setpoint). Manual operation. Possibility of external setpoint influence. Log function. Setpoint ramp. Possibility of digital remote-control functions: System on/off. Max., min. or user-defined duty. Up to 6 alternative setpoints. Digital inputs and outputs can be configured individually. Pump and system monitoring functions: Minimum and maximum limits of current value. Inlet pressure. Non-return valve monitoring. Motor protection. Sensors and cables monitored for malfunction. Alarm log with the previous 24 warnings/alarms. Display and indication functions: Colour screen display. Green indicator light for operating indications and red indicator light for fault indications Potential-free changeover contacts for operation and fault. Grundfos bus communication.</p> <p>It is possible to add CIM communication modules for communicating with Scada/BMS.</p> <p>Pumps, piping, cabling complete as well as Control MPC are mounted on the base frame. The booster system has been preset and tested.</p> <p>There are options to upgrade the pressure boosting system.</p> <table data-bbox="199 1400 877 1646"> <tr> <td>Flow media:</td> <td>Water</td> </tr> <tr> <td>Allowed liquid temp.:</td> <td>5 °C .. 60 °C</td> </tr> <tr> <td>System pressure max.:</td> <td>16 bar</td> </tr> <tr> <td>Flow (Plant):</td> <td>280 m³/h</td> </tr> <tr> <td>Flow without one stand-by pump acc. DIN 1988/T5:</td> <td>210 m³/h</td> </tr> <tr> <td>Nom. current of plant:</td> <td>146 A</td> </tr> <tr> <td>Nominal power:</td> <td>18.5 kW</td> </tr> <tr> <td>Net weight:</td> <td>1190 kg</td> </tr> </table>	Flow media:	Water	Allowed liquid temp.:	5 °C .. 60 °C	System pressure max.:	16 bar	Flow (Plant):	280 m³/h	Flow without one stand-by pump acc. DIN 1988/T5:	210 m³/h	Nom. current of plant:	146 A	Nominal power:	18.5 kW	Net weight:	1190 kg
Flow media:	Water																
Allowed liquid temp.:	5 °C .. 60 °C																
System pressure max.:	16 bar																
Flow (Plant):	280 m³/h																
Flow without one stand-by pump acc. DIN 1988/T5:	210 m³/h																
Nom. current of plant:	146 A																
Nominal power:	18.5 kW																
Net weight:	1190 kg																

98427055 Hydro MPC-E 4 CRE 45-3 50 Hz

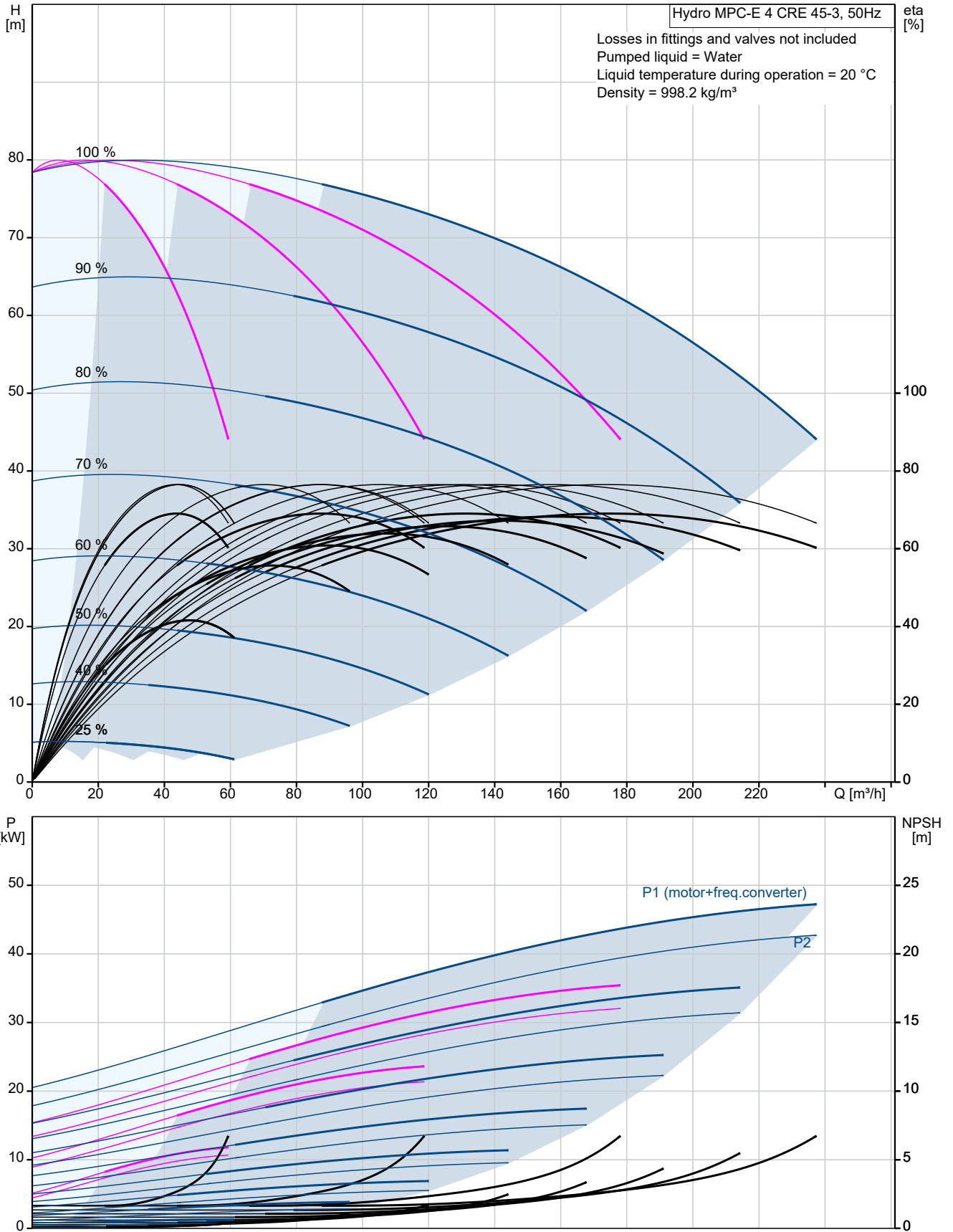

Description	Value
General information:	
Product name:	Hydro MPC-E 4 CRE 45-3
Product No:	98427055
EAN number:	5711494819591
Technical:	
Rated flow:	216 m ³ /h
Max flow:	280 m ³ /h
Max flow system:	210 m ³ /h
Rated head:	86.1 m
Head max:	111.2 m
Main pump name:	CRE 45-3
Main pump No:	96123406
Number of pumps:	4
Non-ret. valve:	at discharge side
Materials:	
Manifolds:	EN/DIN 1.4571/ AISI 316 Ti
Installation:	
Range of ambient temperature:	5 .. 40 °C
Maximum operating pressure:	16 bar
Maximum permissible inlet pressure:	9.9 bar
Manifold inlet:	
Manifold inlet:	DN200
Manifold outlet:	
Manifold outlet:	DN200
Pressure rating:	PN 16
Earth connection:	N, PE
System design:	D
Liquid:	
Pumped liquid:	Water
Liquid temperature range:	5 .. 60 °C
Selected liquid temperature:	20 °C
Density:	998.2 kg/m ³
Electrical data:	
Power (P2) main pump:	18.5 kW
Mains frequency:	50 Hz
Rated voltage:	3 x 380-415 V
Rated current of system:	146 A
Start. method:	electronically
Enclosure class (IEC 34-5):	IP54
Radio interference suppression:	EMC DIRECTIVE(2014/30/EU)
Number of phases of main pump:	3
Controls:	
Control type:	E
Dry running protection, mechanical:	PRESSURE SENSOR 0-4 BAR
Tank:	
Volume of pressure tank:	12 l
Diaphragm tank:	Yes
Others:	
Basis plant:	Y
Net weight:	1190 kg
Gross weight:	1250 kg
Sales region:	Great Britain
Config. file no:	98272446
Config.file Control MPC:	98271948
Config.file Hydro MPC:	98272020

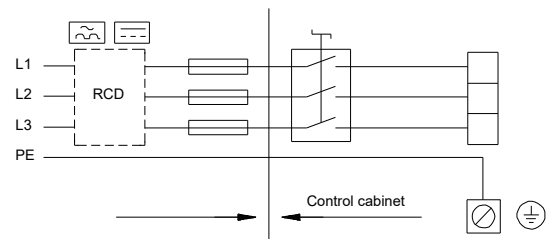
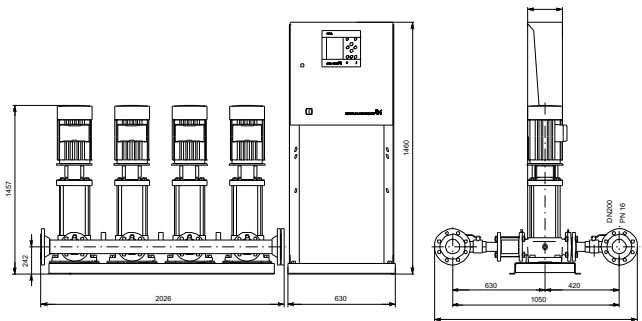
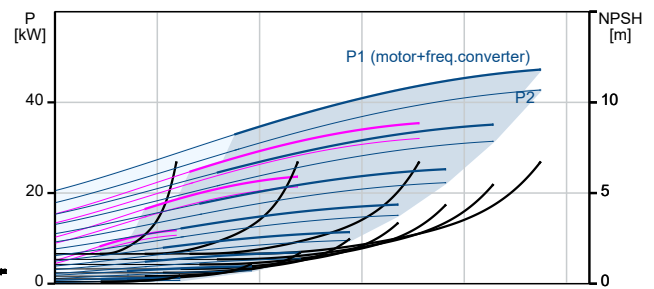
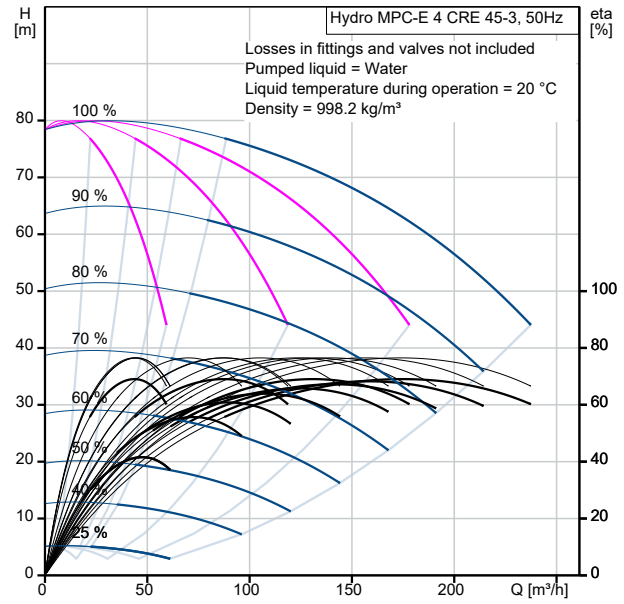

98427055 Hydro MPC-E 4 CRE 45-3 50 Hz

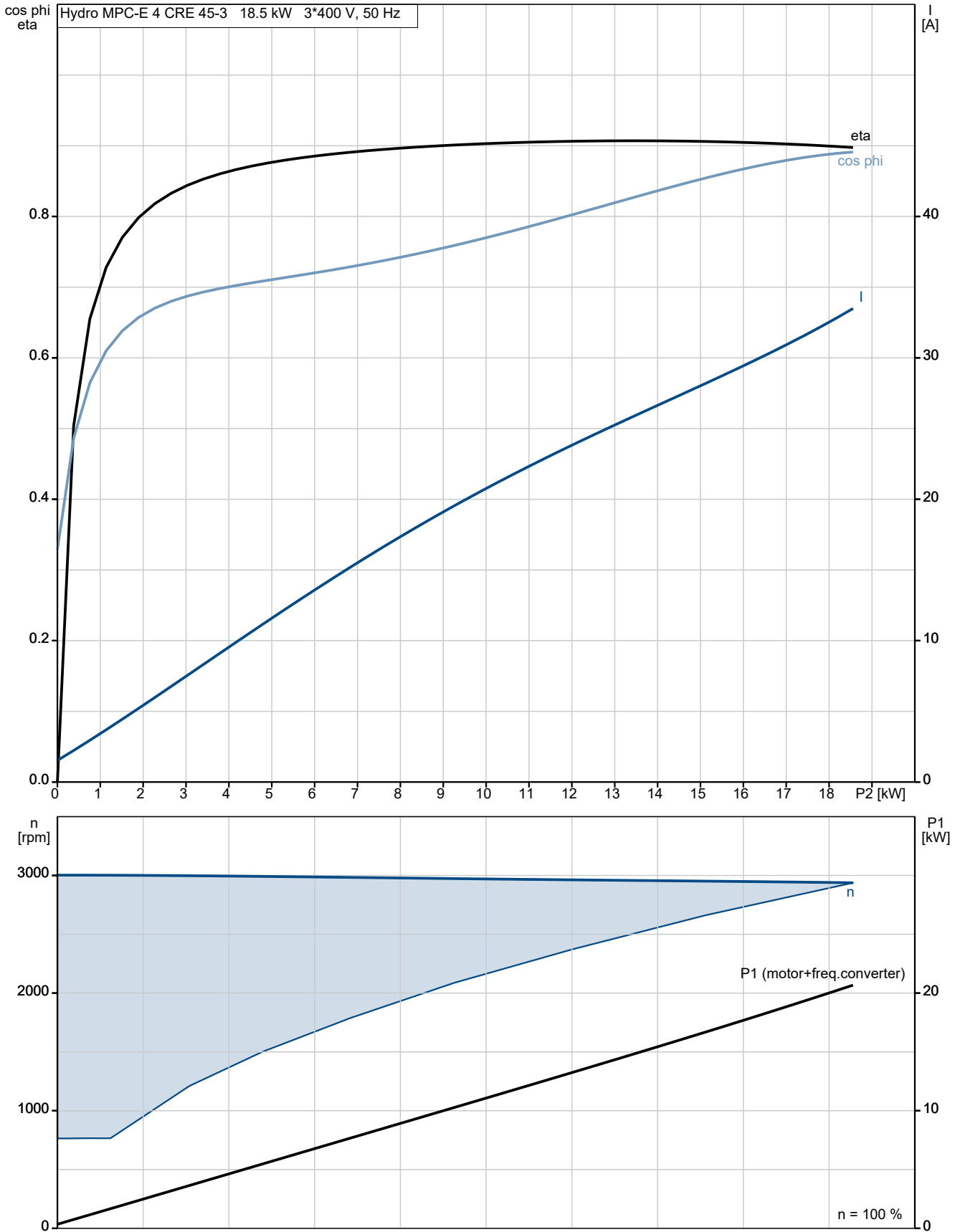



Company name:
Created by:
Phone:

Date: 07/11/2022

98427055 Hydro MPC-E 4 CRE 45-3 50 Hz

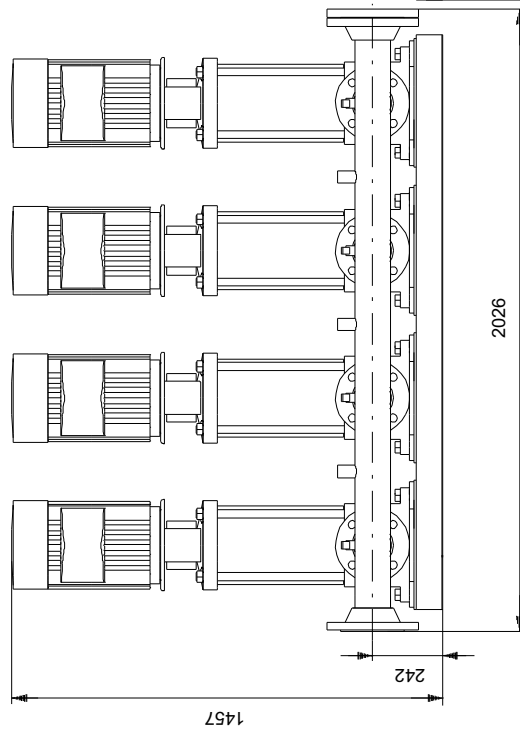
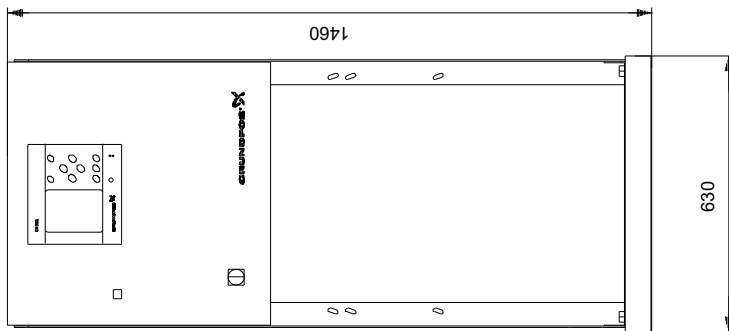
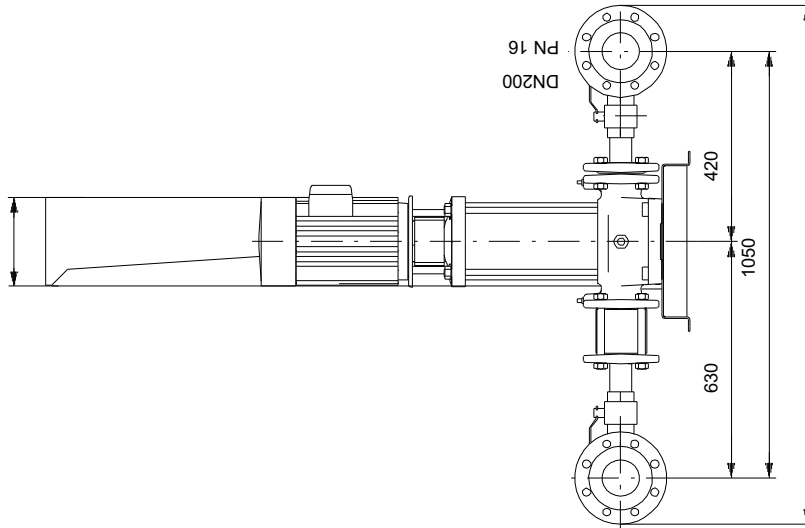

Note! All units are in [mm] unless others are stated.
Disclaimer: This simplified dimensional drawing does not show all details.

98427055 Hydro MPC-E 4 CRE 45-3 50 Hz

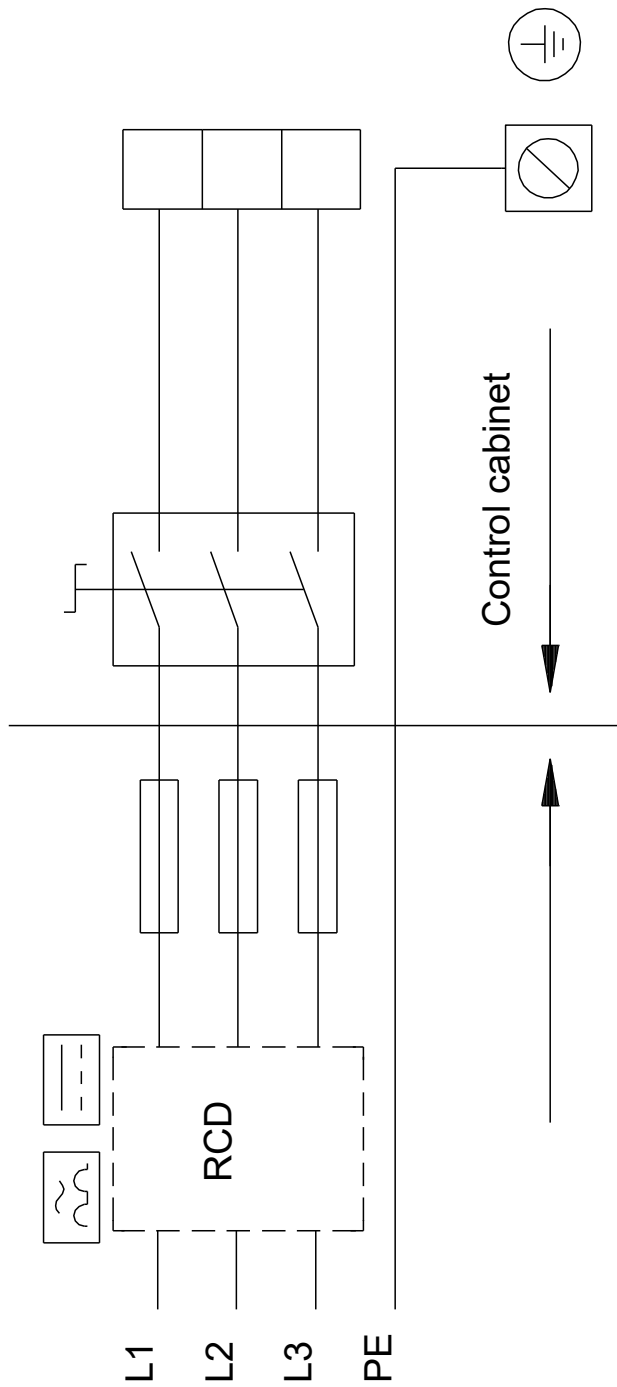

Note! All units are in [mm] unless others are stated.

