

Qty. Description

1 NK 50-160/150 AA2F2AESBQQEMW1



Note! Product picture may differ from actual product

Product No.: [98249313](#)

Non-self-priming, single-stage, centrifugal pump designed according to ISO 5199 with dimensions and rated performance according to EN 733. Flanges are PN 16 with dimensions according to EN 1092-2. The pump has an axial suction port, a radial discharge port and horizontal shaft. It is of the back pull-out design enabling removal of the coupling, bearing bracket and impeller without disturbing the motor, pump housing or pipework.

The unbalanced rubber bellows seal is according to DIN EN 12756.

The pump is fitted with a foot-mounted, fan-cooled asynchronous motor. Pump and motor are mounted on a common base frame.

The product's minimum efficiency index (MEI) is greater or equal to 0.70. This is by the Commission Regulation (EU) considered as an indicative benchmark for best-performing water pump available on the market as from 1 January 2013.

Pump and motor are mounted on a common steel base frame in accordance with ISO 3661.

The back pull-out design together with a spacer coupling makes it possible to service the pump without dismantling the pump housing and motor from the base frame.

This saves realignment of pump and motor after service.

- 1) Remove coupling.
- 2) Remove the bolts in the bearing bracket support foot.
- 3) Remove the bearing bracket from the pump housing.



Pump

The pump housing has both a priming and a drain hole closed by plugs. The impeller is a closed impeller with double-curved blades with smooth surfaces. The impeller is statically balanced according to ISO 1940-1 class G6.3 and hydraulically balanced to compensate for axial thrust.

Wear rings used in pump housing and for impeller are made of bronze/brass.

The pump is fitted with an unbalanced rubber bellows seal with torque transmission across the spring and around the bellows. Due to the bellows, the seal does not wear the shaft, and the axial movement is not prevented by deposits on the shaft.

{IMG Filename: GRALON_NB-NK-G_SHAFTSEAL_Bxxx.gif }

Seal faces:

- Rotating seal ring material: silicon carbide (SiC)
- Stationary seat material: silicon carbide (SiC)

This material pairing is used where higher corrosion resistance is required. The high hardness of this material pairing offers good resistance against abrasive particles.

Secondary seal material: EPDM (ethylene-propylene rubber)

EPDM has excellent resistance to hot water. EPDM is not suitable for mineral oils.

The shaft is made of stainless steel and has a diameter of 24 mm where the coupling is mounted.

The pump uses a spacer coupling between the pump and motor shaft.



Motor

The motor is a totally enclosed, fan-cooled motor with principal dimensions to IEC and DIN standards. Electrical tolerances comply with IEC 60034.

The motor efficiency is classified as IE3 in accordance with IEC 60034-30-1.

The motor has thermistors (PTC sensors) in the windings in accordance with DIN 44081/DIN 44082. The protection reacts to both slow- and quick-rising temperatures, e.g. constant overload and stalled conditions.

Thermal switches must be connected to an external control circuit in a way which ensures that the automatic reset cannot cause accidents. The motors must be connected to a motor-protective circuit breaker according to local regulations.

The motor can be connected to a variable speed drive for adjustment of pump performance to any duty point. Grundfos CUE offers a range of variable speed drives. Please find more information in Grundfos Product Center.

Further product details

Cast-iron parts have an epoxy-based coating made in a cathodic electro-deposition (CED) process. CED is a high-quality dip-painting process where an electrical field around the products ensures deposition of paint particles as a thin, well-controlled layer on the surface.

Technical data

Controls:

Frequency converter: NONE

Pressure sensor: N

Liquid:

Pumped liquid: Water

Liquid temperature range: -25 .. 120 °C

Selected liquid temperature: 20 °C

Density: 998.2 kg/m³

Technical:

Pump speed on which pump data are based: 2915 rpm

Rated flow: 77.2 m³/h

Pump with motor (Yes/No): Y

Rated head: 25.56 m

Actual impeller diameter: 150 mm

Nominal impeller diameter: 160

Code for shaft seal: BQQE

Mechanical seal type: Single

Curve tolerance: ISO9906:2012 3B2

Bearing design: Standard

Materials:

Pump housing: Cast iron
EN-GJL-250
ASTM class 35

Wear ring: Brass

Impeller: Cast iron
EN-GJL-200

Qty.	Description
	<p>ASTM class 30</p> <p>Internal pump house coating: CED</p> <p>Shaft: Stainless steel</p> <p>EN 1.4301</p> <p>AISI 304</p> <p>Installation:</p> <p>t max amb: 60 °C</p> <p>Maximum operating pressure: 16 bar</p> <p>Pipe connection standard: EN 1092-2</p> <p>Type of inlet connection: DIN</p> <p>Type of outlet connection: DIN</p> <p>Size of inlet connection: DN 65</p> <p>Size of outlet connection: DN 50</p> <p>Pressure rating for connection: PN 16</p> <p>Coupling type: Flexible w/spacer</p> <p>Base frame design: EN/ISO</p> <p>Code for base frame: 5</p> <p>Grouting (Yes/No): N</p> <p>Electrical data:</p> <p>Motor type: 132SB</p> <p>IE Efficiency class: IE3</p> <p>Rated power - P2: 7.5 kW</p> <p>Mains frequency: 50 Hz</p> <p>Rated voltage: 3 x 380-415D/660-690Y V</p> <p>Rated current: 14,4-14,0/8,30-8,10 A</p> <p>Starting current: 780-910 %</p> <p>Cos phi - power factor: 0.88-0.86</p> <p>Rated speed: 2910-2920 rpm</p> <p>Efficiency: IE3 90,1% - IE3 90,4%</p> <p>Motor efficiency at full load: 90.1-90.4 %</p> <p>Motor efficiency at 3/4 load: 90.8 %</p> <p>Motor efficiency at 1/2 load: 90.8 %</p> <p>Number of poles: 2</p> <p>Enclosure class (IEC 34-5): 55 Dust/Jetting</p> <p>Insulation class (IEC 85): F</p> <p>Motor No: 87370377</p> <p>Bearing insulation type N-end: STEEL BEARING</p> <p>Others:</p> <p>Minimum efficiency index, MEI ≥: 0.70</p> <p>Net weight: 167 kg</p> <p>Gross weight: 187 kg</p> <p>Shipping volume: 0.395 m³</p> <p>Country of origin: HU</p> <p>Custom tariff no.: 84137059</p>

98249313 NK 50-160/150 AA2F2AESBQQEMW1 50 Hz

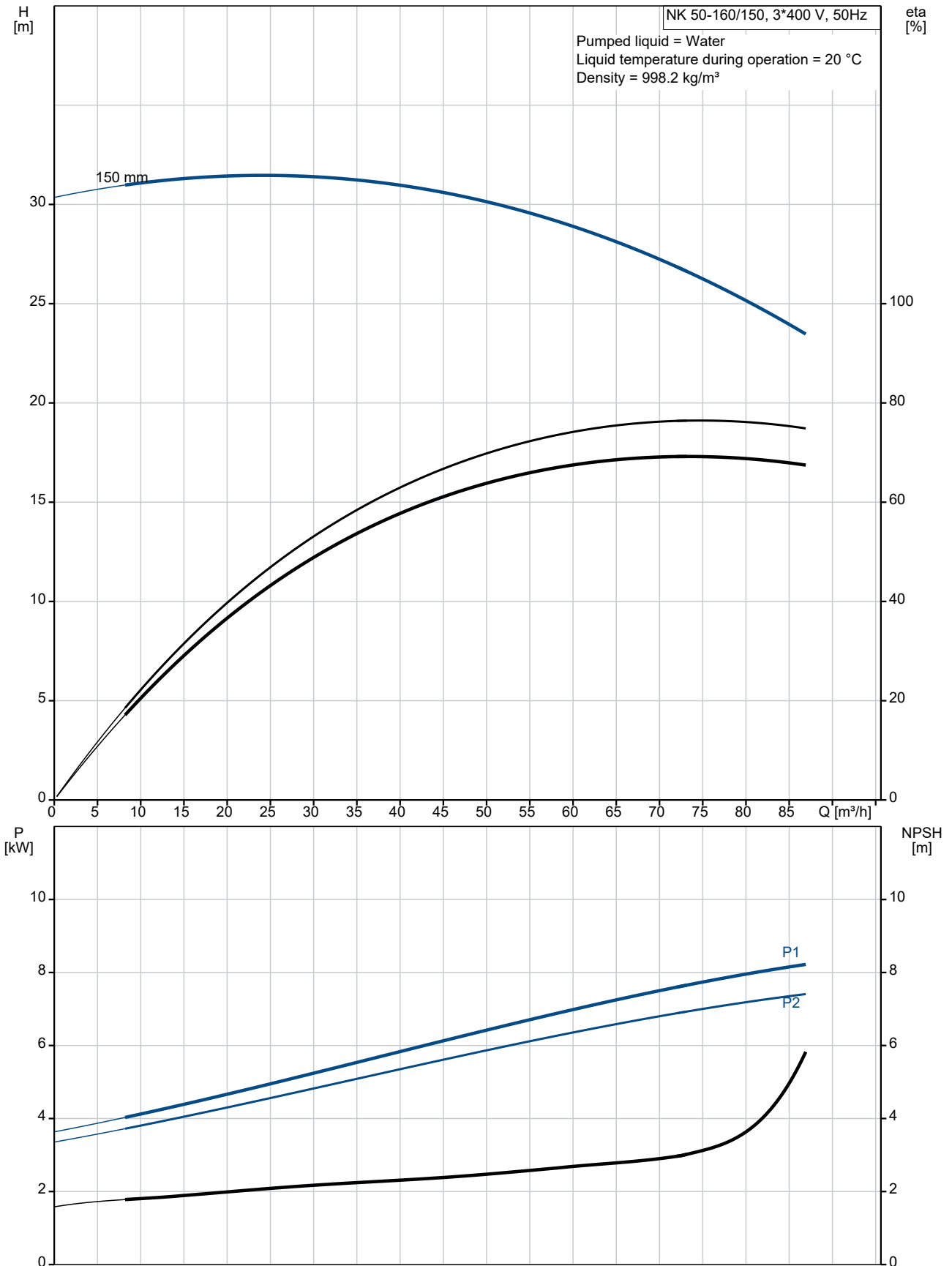

Description	Value
General information:	
Product name:	NK 50-160/150 AA2F2AESBQQEMW1
Product No:	98249313
EAN number:	5711492067215
Technical:	
Pump speed on which pump data are based:	2915 rpm
Rated flow:	77.2 m ³ /h
Pump with motor (Yes/No):	Y
Rated head:	25.56 m
Actual impeller diameter:	150 mm
Nominal impeller diameter:	160
Shaft diameter:	24 mm
Code for shaft seal:	BQQE
Mechanical seal type:	Single
Curve tolerance:	ISO9906:2012 3B2
Pump version:	A2
Bearing design:	Standard
Materials:	
Pump housing:	Cast iron
Pump housing:	EN-GJL-250
Pump housing:	ASTM class 35
Wear ring:	Brass
Impeller:	Cast iron
Impeller:	EN-GJL-200
Impeller:	ASTM class 30
Internal pump house coating:	CED
Material code:	A
Code for rubber:	E
Shaft:	Stainless steel
Shaft:	EN 1.4301
Shaft:	AISI 304
Installation:	
t max amb:	60 °C
Maximum operating pressure:	16 bar
Pipe connection standard:	EN 1092-2
Type of inlet connection:	DIN
Type of outlet connection:	DIN
Size of inlet connection:	DN 65
Size of outlet connection:	DN 50
Pressure rating for connection:	PN 16
Coupling type:	Flexible w/spacer
Base frame design:	EN/ISO
Code for base frame:	5
Grouting (Yes/No):	N
Connect code:	F
Liquid:	
Pumped liquid:	Water
Liquid temperature range:	-25 .. 120 °C
Selected liquid temperature:	20 °C
Density:	998.2 kg/m ³
Electrical data:	
Motor type:	132SB
IE Efficiency class:	IE3
Rated power - P2:	7.5 kW
Mains frequency:	50 Hz
Rated voltage:	3 x 380-415D/660-690Y V
Rated current:	14,4-14,0/8,30-8,10 A

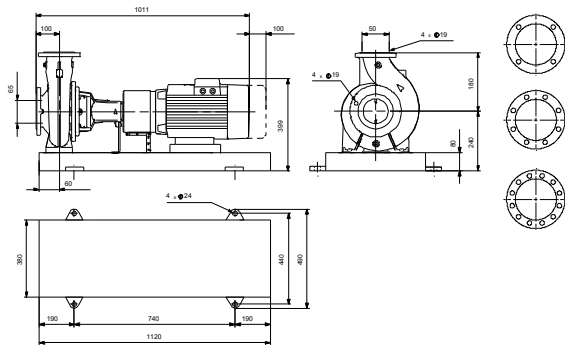
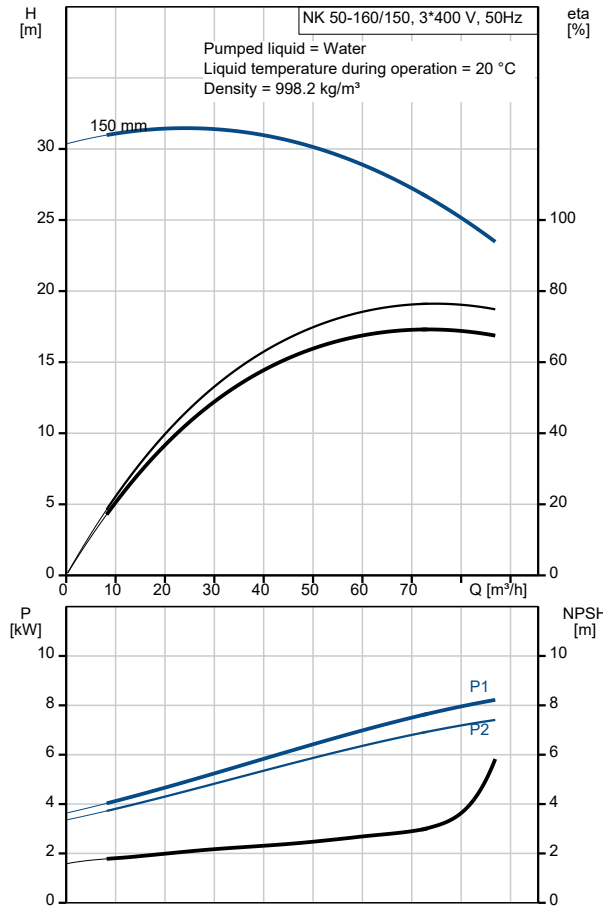



Company name:

Created by:

Phone:

Date:

16/06/2022

Description	Value
Starting current:	780-910 %
Cos phi - power factor:	0.88-0.86
Rated speed:	2910-2920 rpm
Efficiency:	IE3 90,1% - IE3 90,4%
Motor efficiency at full load:	90.1-90.4 %
Motor efficiency at 3/4 load:	90.8 %
Motor efficiency at 1/2 load:	90.8 %
Number of poles:	2
Enclosure class (IEC 34-5):	55 Dust/Jetting
Insulation class (IEC 85):	F
Built-in motor protection:	PTC
Motor No:	87370377
Bearing insulation type N-end:	STEEL BEARING
Controls:	
Frequency converter:	NONE
Pressure sensor:	N
Others:	
Minimum efficiency index, MEI ≥:	0.70
Net weight:	167 kg
Gross weight:	187 kg
Shipping volume:	0.395 m ³
Country of origin:	HU
Custom tariff no.:	84137059

98249313 NK 50-160/150 AA2F2AESBQQEMW1 50 Hz

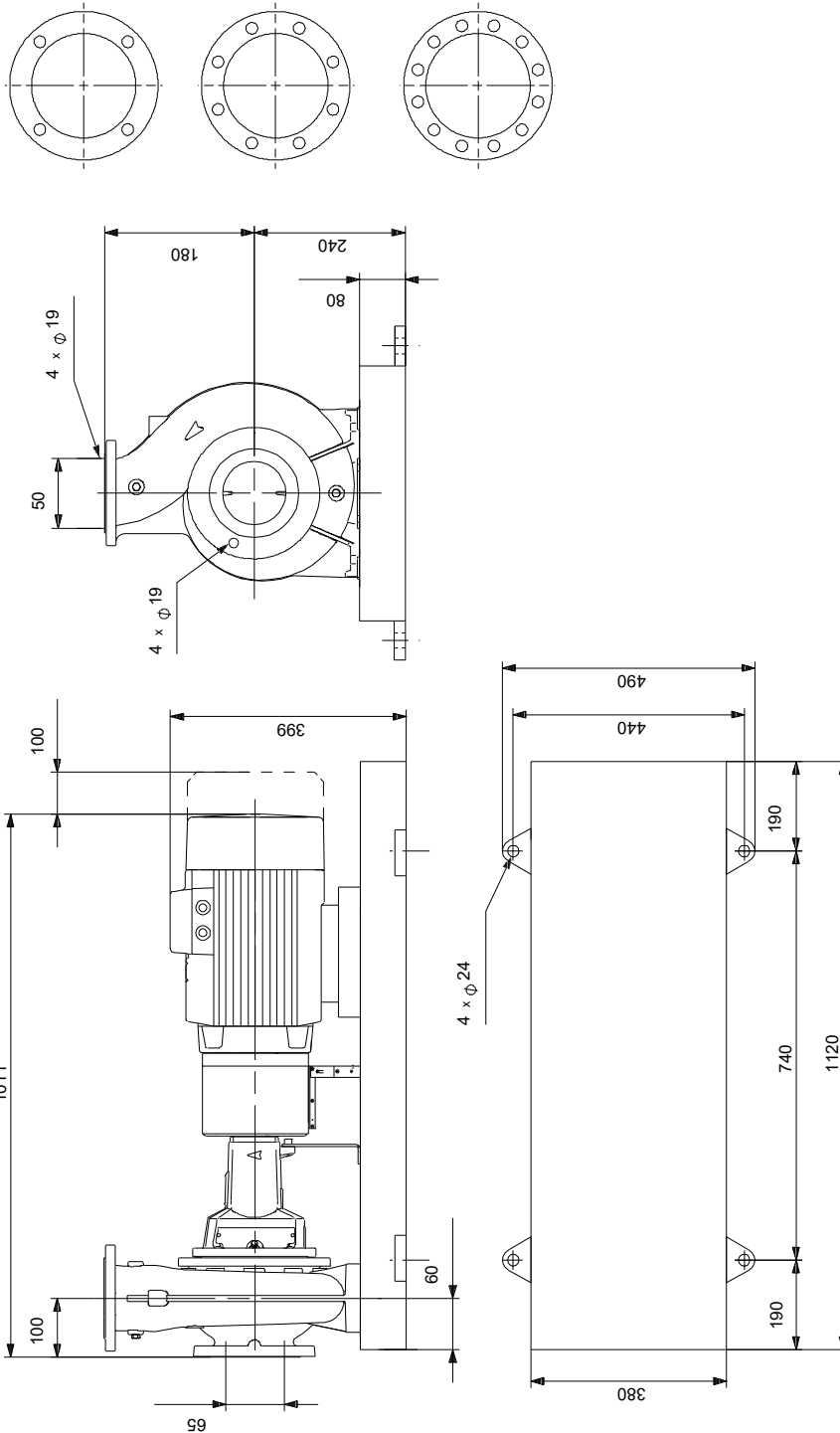

Note! All units are in [mm] unless others are stated.
Disclaimer: This simplified dimensional drawing does not show all details.

98249313 NK 50-160/150 AA2F2AESBQQEMW1 50 Hz



Note! All units are in [mm] unless others are stated.



Company name:

Created by:

Phone:

Date:

16/06/2022

Order Data:

Product name: NK 50-160/150

Amount: 1

Product No: 98249313

Total: Price on request
