

Qty. Description

1 NB 80-200/214 AAF2AESBQQELW3



Product No.: [98175428](#)

Non-self-priming, single-stage, centrifugal volute pump designed according to ISO 5199 with dimensions and rated performance according to EN 733 (10 bar).

Flanges are PN 16 with dimensions according to EN 1092-2. The pump has an axial suction port, radial discharge port, horizontal shaft and a back pull-out design enabling removal of the motor, motor stool, cover and impeller without disturbing the pump housing or pipework.

The unbalanced rubber bellows seal is according to DIN EN 12756.

The pump is close-coupled to a fan-cooled asynchronous motor.

The product's minimum efficiency index (MEI) is greater or equal to 0.70. This is by the Commission Regulation (EU) considered as an indicative benchmark for best-performing water pump available on the market as from 1 January 2013.

The back pull-out design means that the pump can be serviced by a single person without disturbing the pump housing or pipes.

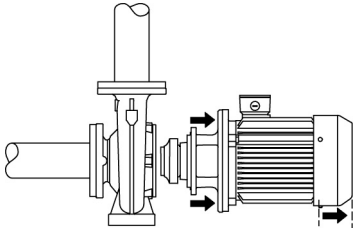

Cast-iron parts have an epoxy-based coating made in a cathodic electro-deposition (CED) process. CED is a high-quality dip-painting process where an electrical field around the products ensures deposition of paint particles as a thin, well-controlled layer on the surface.

Pump

The pump housing has both a priming and a drain hole closed by plugs. The impeller is a closed impeller with double-curved blades with smooth surfaces. The impeller is statically balanced according to ISO 1940-1 class G6.3 and hydraulically balanced to compensate for axial thrust.

Wear rings used in pump housing and for impeller are made of bronze/brass.

Motor stool and pump cover are made of cast iron (EN-GJL-250). Coupling guards are fitted to the motor stool. The pump cover is provided with a manual air vent screw for venting of the pump housing and the shaft seal chamber.

The pump is fitted with an unbalanced rubber bellows seal with torque transmission across the spring and around the bellows. Due to the bellows, the seal does not wear the shaft, and the axial movement is not prevented by deposits on the shaft.

Seal faces:

- Rotating seal ring material: silicon carbide (SiC)
- Stationary seat material: silicon carbide (SiC)

This material pairing is used where higher corrosion resistance is required. The high hardness of this material pairing offers good resistance against abrasive particles.

Secondary seal material: EPDM (ethylene-propylene rubber)

EPDM has excellent resistance to hot water. EPDM is not suitable for mineral oils.

The pump housing has feet.

Motor

Qty.	Description
1	<p>The motor is a totally enclosed, fan-cooled motor with principal dimensions to IEC and DIN standards. Electrical tolerances comply with IEC 60034.</p> <p>The motor efficiency is classified as IE3 in accordance with IEC 60034-30-1.</p> <p>The motor has thermistors (PTC sensors) in the windings in accordance with DIN 44081/DIN 44082. The protection reacts to both slow- and quick-rising temperatures, e.g. constant overload and stalled conditions.</p> <p>Thermal switches must be connected to an external control circuit in a way which ensures that the automatic reset cannot cause accidents. The motors must be connected to a motor-protective circuit breaker according to local regulations.</p> <p>The motor can be connected to a variable speed drive for adjustment of pump performance to any duty point. Grundfos CUE offers a range of variable speed drives. Please find more information in Grundfos Product Center.</p> <p>Further product details</p> <p>Cast-iron parts have an epoxy-based coating made in a cathodic electro-deposition (CED) process. CED is a high-quality dip-painting process where an electrical field around the products ensures deposition of paint particles as a thin, well-controlled layer on the surface.</p> <p>Technical data</p> <p>Controls:</p> <p>Frequency converter: NONE</p> <p>Pressure sensor: N</p> <p>Liquid:</p> <p>Pumped liquid: Water</p> <p>Liquid temperature range: -25 .. 120 °C</p> <p>Selected liquid temperature: 20 °C</p> <p>Density: 998.2 kg/m³</p> <p>Technical:</p> <p>Pump speed on which pump data are based: 1470 rpm</p> <p>Rated flow: 104.7 m³/h</p> <p>Rated head: 13.77 m</p> <p>Actual impeller diameter: 214 mm</p> <p>Nominal impeller diameter: 200</p> <p>Shaft seal arrangement: Single</p> <p>Code for shaft seal: BQQE</p> <p>Curve tolerance: ISO9906:2012 3B2</p> <p>Bearing design: Standard</p> <p>Materials:</p> <p>Pump housing: Cast iron EN-GJL-250 ASTM class 35</p> <p>Wear ring: Brass</p> <p>Impeller: Cast iron EN-GJL-200 ASTM class 30</p> <p>Internal pump house coating: CED</p> <p>Shaft: Stainless steel EN 1.4301 AISI 304</p> <p>Installation:</p> <p>t max amb: 55 °C</p> <p>Maximum operating pressure: 16 bar</p> <p>Pipe connection standard: EN 1092-2</p> <p>Size of inlet connection: DN 100</p>

Qty.	Description
1	<p>Size of outlet connection: DN 80 Pressure rating for connection: PN 16 Bearing lubrication: Grease Pump housing with feet: Yes Support block (Yes/No): N</p> <p>Electrical data: Motor type: SIEMENS IE Efficiency class: IE3 Rated power - P2: 5.5 kW Mains frequency: 50 Hz Rated voltage: 3 x 380-420D/660-725Y V Rated current: 10.8/6.1 A Starting current: 850-850 % Cos phi - power factor: 0.82 Rated speed: 1470 rpm Efficiency: IE3 89,6% Motor efficiency at full load: 89.6-89.6 % Motor efficiency at 3/4 load: 90-90 % Motor efficiency at 1/2 load: 89.5-89.5 % Number of poles: 4 Enclosure class (IEC 34-5): IP55 Insulation class (IEC 85): F Motor No: 83V15217 Bearing insulation type N-end: N</p> <p>Others: Minimum efficiency index, MEI ≥: 0.70 Net weight: 117 kg Gross weight: 138 kg Shipping volume: 0.509 m³ Danish VVS No.: 386064208 Country of origin: HU Custom tariff no.: 84137051</p>



Company name: Pump Sales Direct

Created by:

Phone:

Date:

15/08/2022

98175428 NB 80-200/214 AAF2AESBQQELW3 50 Hz

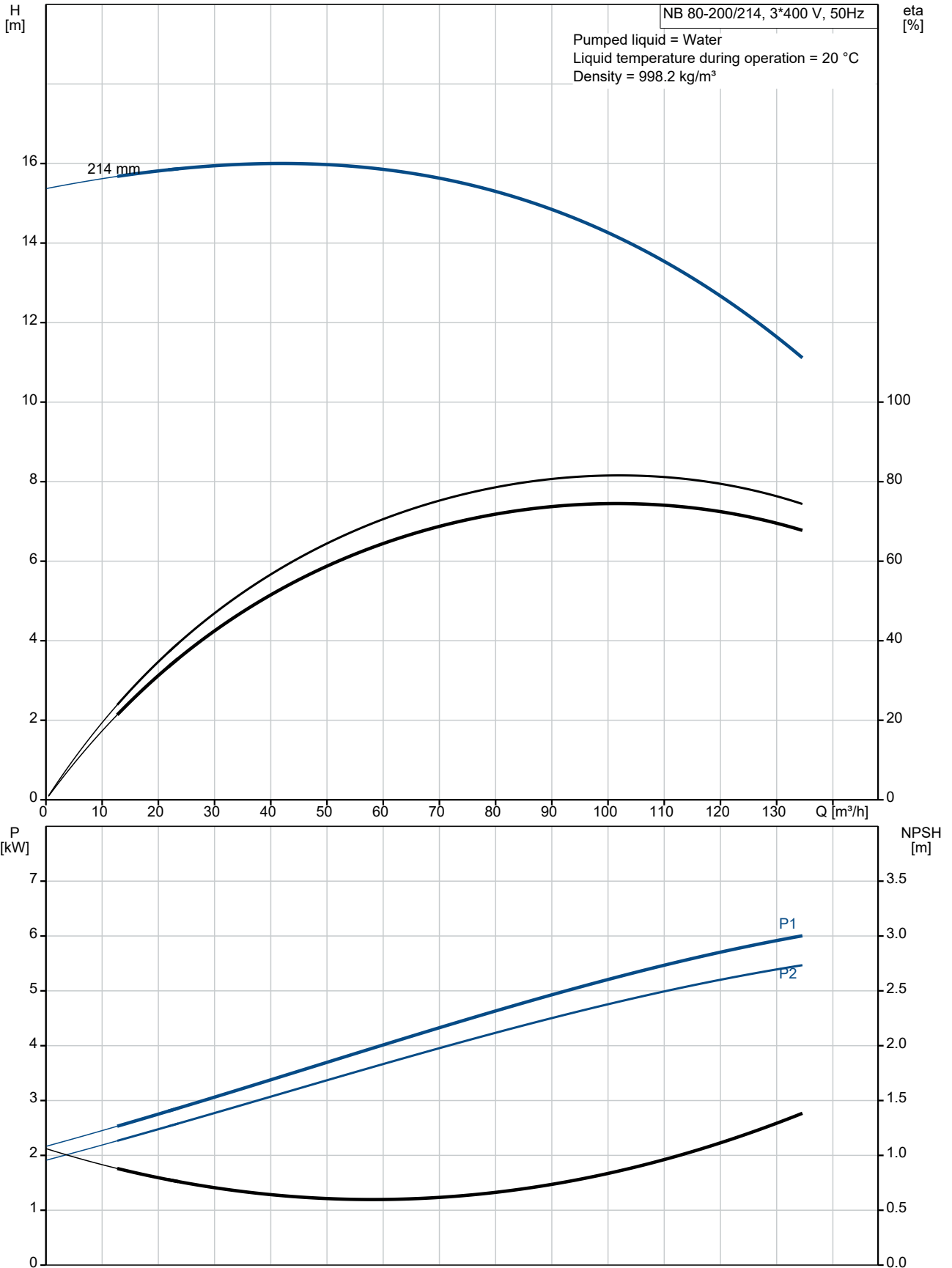

Description	Value
General information:	
Product name:	NB 80-200/214 AAF2AESBQQELW3
Product No:	98175428
EAN number:	5711490914696
Technical:	
Pump speed on which pump data are based:	1470 rpm
Rated flow:	104.7 m ³ /h
Rated head:	13.77 m
Actual impeller diameter:	214 mm
Nominal impeller diameter:	200
Shaft seal arrangement:	Single
Shaft diameter:	32 mm
Code for shaft seal:	BQQE
Curve tolerance:	ISO9906:2012 3B2
Pump version:	A
Bearing design:	Standard
Materials:	
Pump housing:	Cast iron
Pump housing:	EN-GJL-250
Pump housing:	ASTM class 35
Wear ring:	Brass
Impeller:	Cast iron
Impeller:	EN-GJL-200
Impeller:	ASTM class 30
Internal pump house coating:	CED
Material code:	A
Code for rubber:	E
Shaft:	Stainless steel
Shaft:	EN 1.4301
Shaft:	AISI 304
Installation:	
t max amb:	55 °C
Maximum operating pressure:	16 bar
Pipe connection standard:	EN 1092-2
Size of inlet connection:	DN 100
Size of outlet connection:	DN 80
Pressure rating for connection:	PN 16
Bearing lubrication:	Grease
Pump housing with feet:	Yes
Support block (Yes/No):	N
Connect code:	F2
Liquid:	
Pumped liquid:	Water
Liquid temperature range:	-25 .. 120 °C
Selected liquid temperature:	20 °C
Density:	998.2 kg/m ³
Electrical data:	
Motor type:	SIEMENS
IE Efficiency class:	IE3
Rated power - P2:	5.5 kW
Mains frequency:	50 Hz
Rated voltage:	3 x 380-420D/660-725Y V
Rated current:	10.8/6.1 A
Starting current:	850-850 %
Cos phi - power factor:	0.82
Rated speed:	1470 rpm
Efficiency:	IE3 89,6%

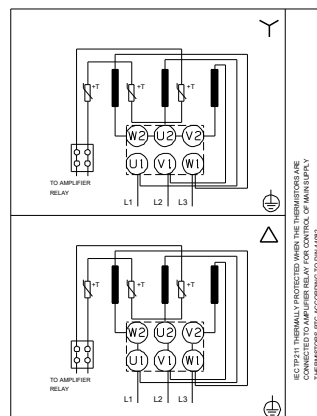
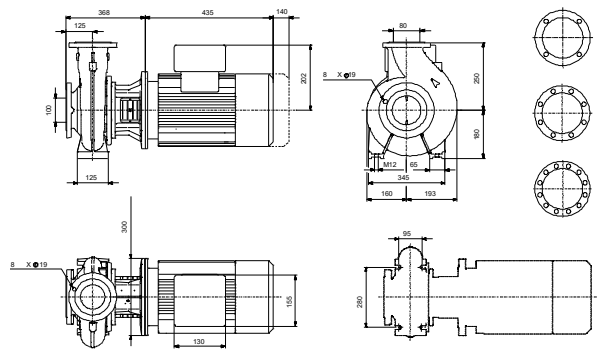
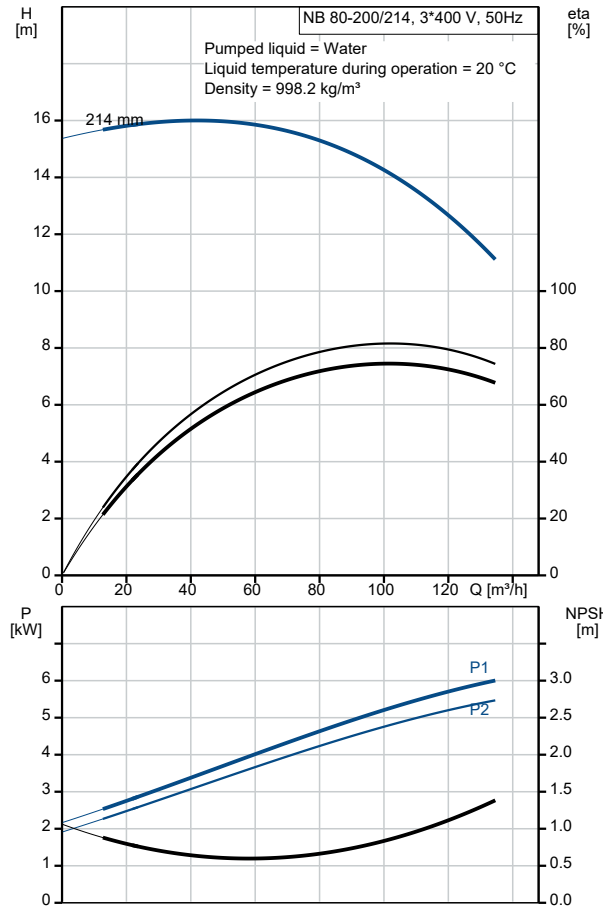



Company name: Pump Sales Direct

Created by:

Phone:

Date: 15/08/2022

Description	Value
Motor efficiency at full load:	89.6-89.6 %
Motor efficiency at 3/4 load:	90-90 %
Motor efficiency at 1/2 load:	89.5-89.5 %
Number of poles:	4
Enclosure class (IEC 34-5):	IP55
Insulation class (IEC 85):	F
Built-in motor protection:	PTC
Motor No:	83V15217
Mount. design. acc. IEC 34-7:	IM V1
Bearing insulation type N-end:	N
Controls:	
Frequency converter:	NONE
Pressure sensor:	N
Others:	
Minimum efficiency index, MEI \geq :	0.70
Net weight:	117 kg
Gross weight:	138 kg
Shipping volume:	0.509 m ³
Danish VVS No.:	386064208
Country of origin:	HU
Custom tariff no.:	84137051

98175428 NB 80-200/214 AAF2AESBQQELW3 50 Hz

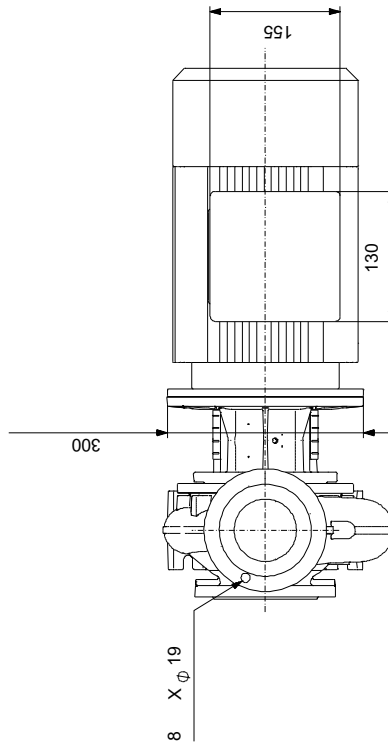
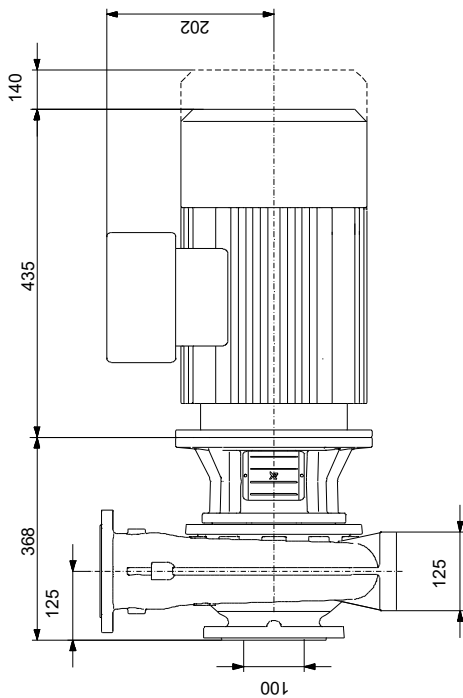
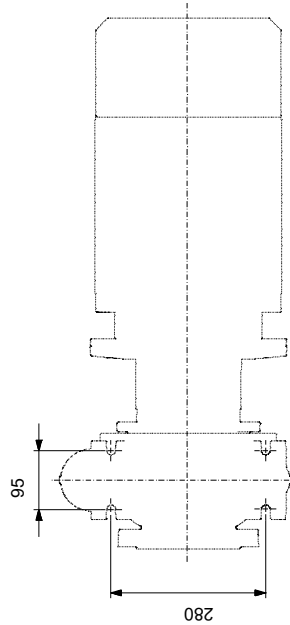
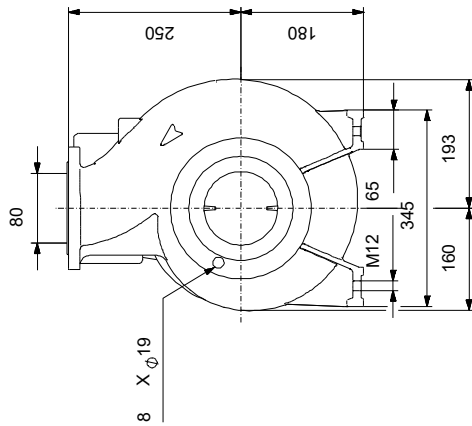
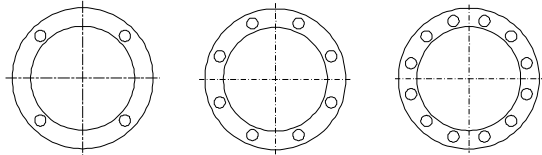

Note! All units are in [mm] unless others are stated.
 Disclaimer: This simplified dimensional drawing does not show all details.

98175428 NB 80-200/214 AAF2AESBQQELW3 50 Hz



IEC TP211 THERMALLY PROTECTED WHEN THE THERMISTORS ARE
CONNECTED TO AMPLIFIER RELAY FOR CONTROL OF MAIN SUPPLY
THERMISTORS PTC ACCORDING TO DIN 44082

Note! All units are in [mm] unless others are stated.

