

Qty. Description

1 CRN 5-13 A-FGJ-H-E-HQQE



Note! Product picture may differ from actual product

Product No.: [96531671](#)

Vertical, multistage centrifugal pump with inlet and outlet ports on same the level (inline). Pump materials in contact with the liquid are in high-grade stainless steel. A cartridge shaft seal ensures high reliability, safe handling, and easy access and service. Power transmission is via a rigid split coupling. Pipe connection is via combined DIN-ANSI-JIS flanges.

The pump is fitted with a 3-phase, fan-cooled asynchronous motor.

Further product details

Steel, cast iron and aluminium components have an epoxy-based coating made in a cathodic electro-deposition (CED) process.

CED is a high-quality dip-painting process where an electrical field around the products ensures deposition of paint particles as a thin, well-controlled layer on the surface.

An integral part of the process is a pretreatment.

The entire process consists of these elements:

- 1) Alkaline-based cleaning.
- 2) Zinc phosphating.
- 3) Cathodic electro-deposition.
- 4) Curing to a dry film thickness 18-22 my m.

The colour code for the finished product is NCS 9000/RAL 9005.

Pump

A standard split coupling connects the pump and motor shaft. It is enclosed in the pump head/motor stool by means of two coupling guards.

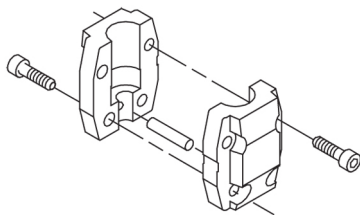

The pump head and flange for motor mounting is made in one piece (cast iron). The pump head cover is a separate component (stainless steel). The pump head has a combined 1/2" priming plug and vent screw.

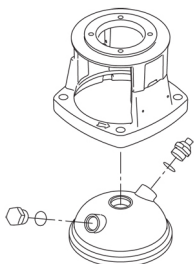

The pump is fitted with a balanced O-ring seal unit with a rigid torque-transmission system. This seal type is assembled in a cartridge unit which makes replacement safe and easy.

Qty. Description

1 Due to the balancing, this seal type is suitable for high-pressure applications. The cartridge construction also protects the pump shaft from possible wear from a dynamic O-ring between pump shaft and shaft seal.

Seal faces:

- Rotating seal ring material: silicon carbide (SiC)
- Stationary seat material: silicon carbide (SiC)

This material pairing is used where higher corrosion resistance is required. The high hardness of this material pairing offers good resistance against abrasive particles.

Secondary seal material: EPDM (ethylene-propylene rubber)
EPDM has excellent resistance to hot water. EPDM is not suitable for mineral oils.

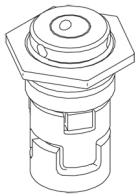

The shaft seal is screwed into the pump head.
The chambers and impellers are made of stainless-steel sheet. The chambers are provided with a PTFE neck ring offering improved sealing and high efficiency. The impellers have smooth surfaces, and the shape of the blades ensure a high efficiency.

The pump has a stainless-steel base mounted on a separate base plate.
This base and base plate are kept in position by the tension of the staybolts which hold the pump together.
The outlet side of the base has a combined drain plug and bypass valve.
The pump is secured to the foundation by four bolts through the base plate.
The flanges and base are cast in one piece and prepared for connection by means of DIN, ANSI or JIS.

Motor

The motor is a totally enclosed, fan-cooled motor with principal dimensions to IEC and DIN standards. The motor is flange-mounted with tapped-hole flange (FT).
Motor-mounting designation in accordance with IEC 60034-7: IM B 14 (Code I) / IM 3601 (Code II).
Electrical tolerances comply with IEC 60034.
The motor efficiency is classified as IE3 in accordance with IEC 60034-30-1.
The motor does not incorporate motor protection and must be connected to a motor-protective circuit breaker which can be manually reset. The motor-protective circuit breaker must be set according to the rated current of the motor (I1/1).
The motor can be connected to a variable speed drive for adjustment of pump performance to any duty point. Grundfos CUE offers a range of variable speed drives. Please find more information in Grundfos Product Center.

Technical data

Liquid:
Pumped liquid: Water
Liquid temperature range: -20 .. 120 °C
Selected liquid temperature: 20 °C
Density: 998.2 kg/m³

Technical:
Pump speed on which pump data are based: 2899 rpm
Rated flow: 5.8 m³/h
Rated head: 66.1 m
Pump orientation: Vertical
Shaft seal arrangement: Single
Code for shaft seal: HQQE
Approvals: CE,EAC,UKCA,SEPRO
Approvals for drinking water: WRAS,ACS
Curve tolerance: ISO9906:2012 3B

Qty.	Description
1	<p>Materials:</p> <p>Base: Stainless steel EN 1.4408 AISI 316</p> <p>Impeller: Stainless steel EN 1.4401 AISI 316</p> <p>Bearing: SIC</p> <p>Installation:</p> <p>t max amb: 60 °C</p> <p>Maximum operating pressure: 25 bar</p> <p>Max pressure at stated temp: 25 bar / 120 °C 25 bar / -20 °C</p> <p>Type of connection: DIN / ANSI / JIS</p> <p>Size of inlet connection: DN 25/32</p> <p>Size of outlet connection: DN 25/32</p> <p>Pressure rating for connection: PN 25</p> <p>Flange rating inlet: 300 lb</p> <p>Flange size for motor: FT115</p> <p>Electrical data:</p> <p>Motor standard: IEC</p> <p>Motor type: 90LE</p> <p>IE Efficiency class: IE3</p> <p>Rated power - P2: 2.2 kW</p> <p>Power (P2) required by pump: 2.2 kW</p> <p>Mains frequency: 50 Hz</p> <p>Rated voltage: 3 x 220-240D/380-415Y V</p> <p>Rated current: 8.00/4.60 A</p> <p>Starting current: 840-920 %</p> <p>Cos phi - power factor: 0.86-0.80</p> <p>Rated speed: 2890-2910 rpm</p> <p>Efficiency: IE3 85,9%</p> <p>Motor efficiency at full load: 85.9-85.9 %</p> <p>Motor efficiency at 3/4 load: 88.2 %</p> <p>Motor efficiency at 1/2 load: 88.0 %</p> <p>Number of poles: 2</p> <p>Enclosure class (IEC 34-5): 55 Dust/Jetting</p> <p>Insulation class (IEC 85): F</p> <p>Motor No: 85U01908</p> <p>Controls:</p> <p>Frequency converter: NONE</p> <p>Others:</p> <p>Minimum efficiency index, MEI ≥: 0.57</p> <p>Net weight: 39.9 kg</p> <p>Gross weight: 42.8 kg</p> <p>Shipping volume: 0.13 m³</p>



Company name:
Created by:
Phone:

Date: 30/11/2022

96531671 CRN 5-13 A-FGJ-H-E-HQQE 50 Hz

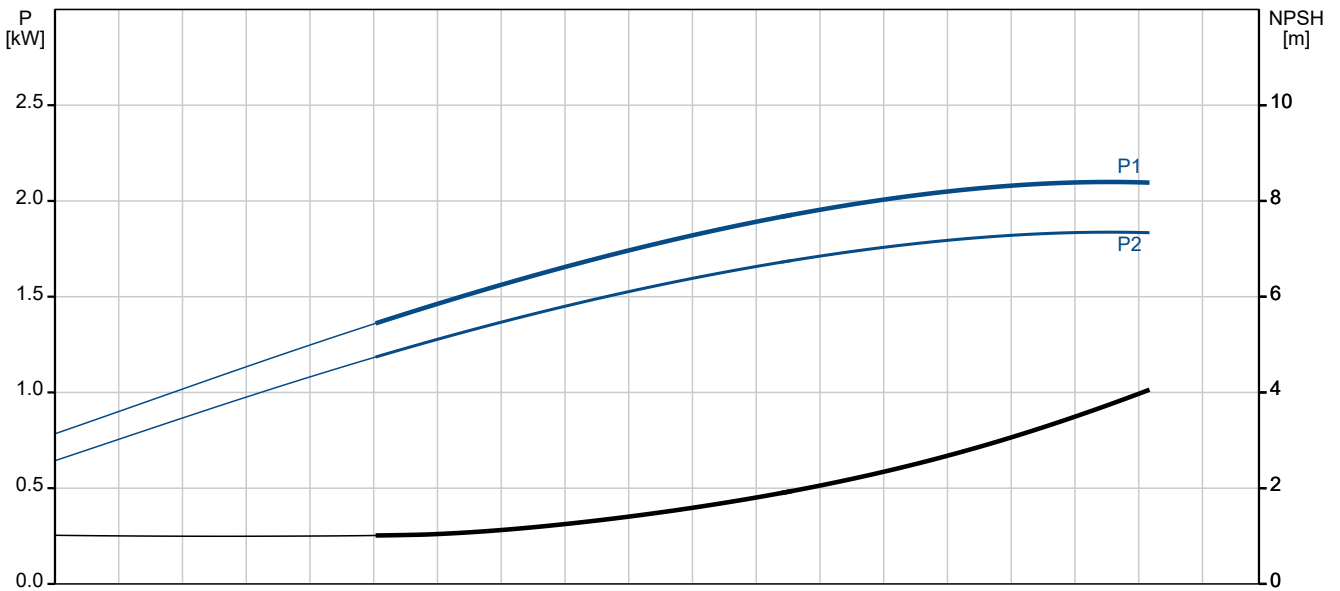
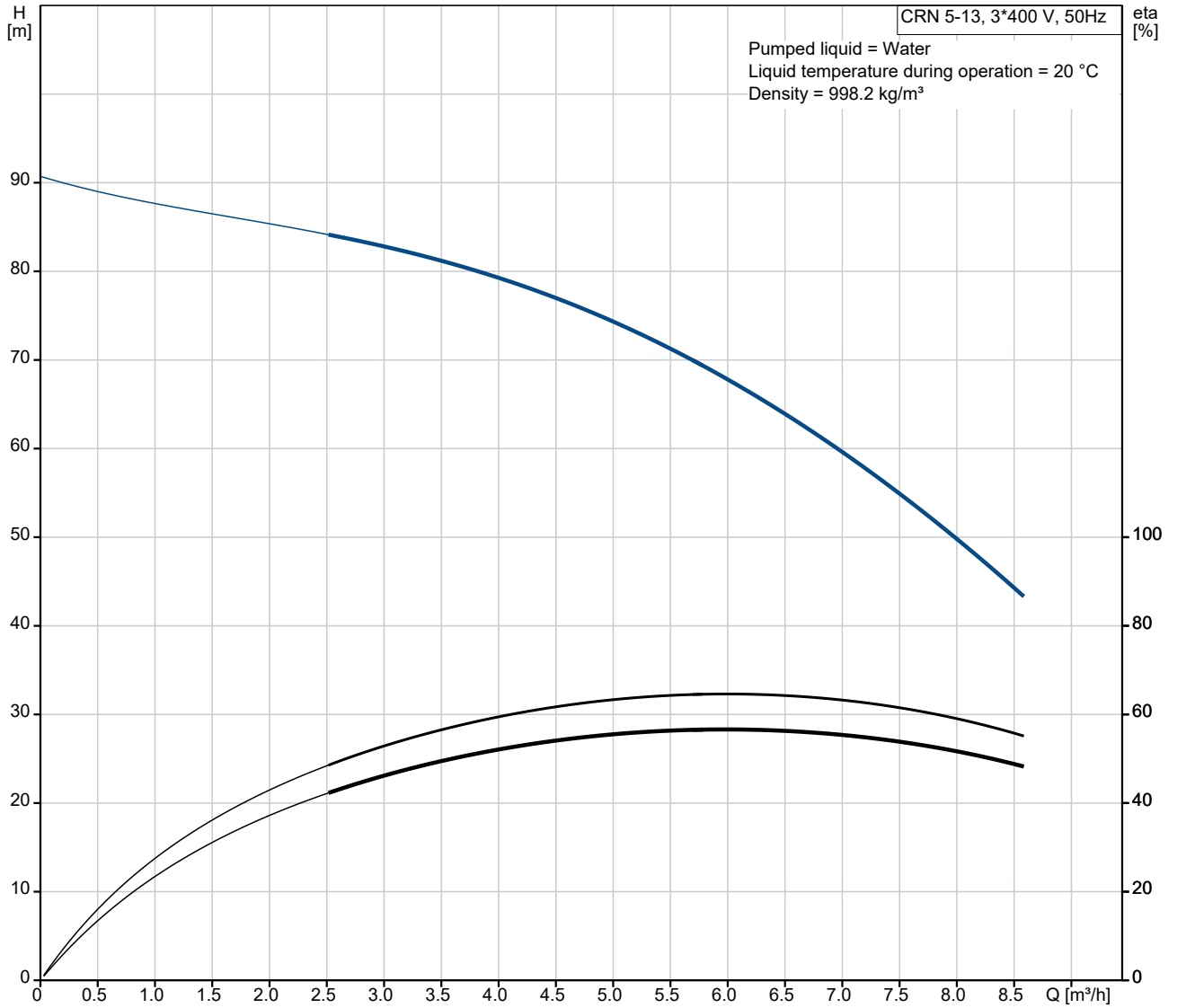

Description	Value
General information:	
Product name:	CRN 5-13 A-FGJ-H-E-HQQE
Product No:	96531671
EAN number:	5700397305744
Technical:	
Pump speed on which pump data are based:	2899 rpm
Rated flow:	5.8 m ³ /h
Rated head:	66.1 m
Maximum head:	88.4 m
Stages:	13
Impellers:	13
Number of reduced-diameter impellers:	0
Low NPSH:	N
Pump orientation:	Vertical
Shaft seal arrangement:	Single
Code for shaft seal:	HQQE
Approvals:	CE,EAC,UKCA,SEPRO
Approvals for drinking water:	WRAS,ACS
Curve tolerance:	ISO9906:2012 3B
Pump version:	A
Model:	A
Materials:	
Base:	Stainless steel
Base:	EN 1.4408
Base:	AISI 316
Impeller:	Stainless steel
Impeller:	EN 1.4401
Impeller:	AISI 316
Material code:	H
Code for rubber:	E
Bearing:	SIC
Installation:	
t max amb:	60 °C
Maximum operating pressure:	25 bar
Max pressure at stated temp:	25 bar / 120 °C
Max pressure at stated temp:	25 bar / -20 °C
Type of connection:	DIN / ANSI / JIS
Size of inlet connection:	DN 25/32
Size of outlet connection:	DN 25/32
Pressure rating for connection:	PN 25
Flange rating inlet:	300 lb
Flange size for motor:	FT115
Connect code:	FGJ
Liquid:	
Pumped liquid:	Water
Liquid temperature range:	-20 .. 120 °C
Selected liquid temperature:	20 °C
Density:	998.2 kg/m ³
Electrical data:	
Motor standard:	IEC
Motor type:	90LE
IE Efficiency class:	IE3
Rated power - P2:	2.2 kW
Power (P2) required by pump:	2.2 kW
Mains frequency:	50 Hz
Rated voltage:	3 x 220-240D/380-415Y V

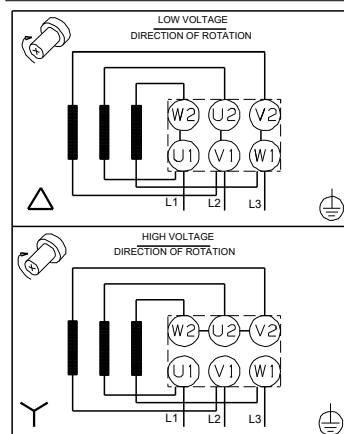
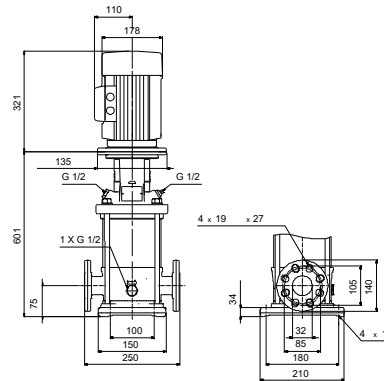
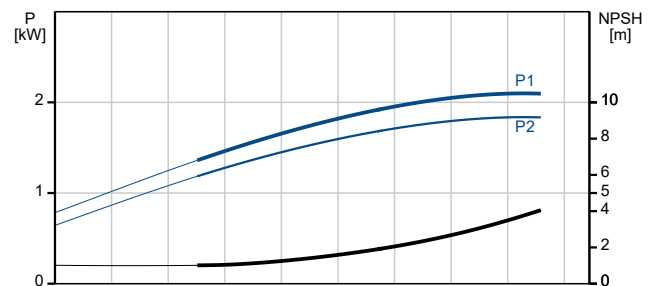
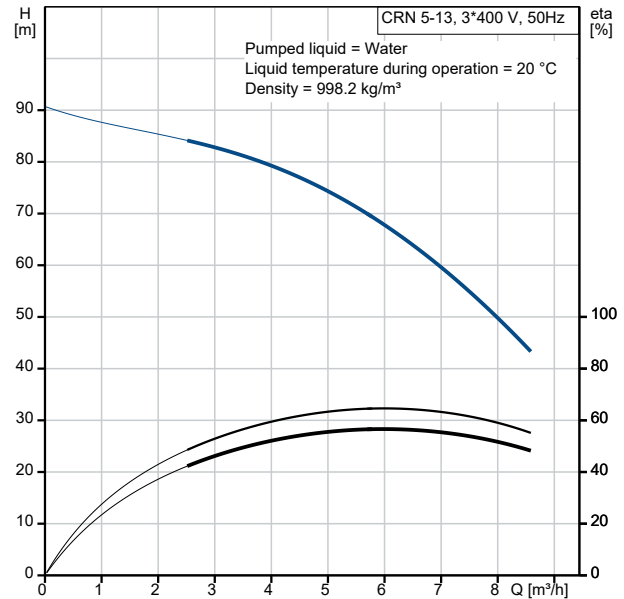



Company name:

Created by:

Phone:

Date:

30/11/2022

Description	Value
Rated current:	8.00/4.60 A
Starting current:	840-920 %
Cos phi - power factor:	0.86-0.80
Rated speed:	2890-2910 rpm
Efficiency:	IE3 85.9%
Motor efficiency at full load:	85.9-85.9 %
Motor efficiency at 3/4 load:	88.2 %
Motor efficiency at 1/2 load:	88.0 %
Number of poles:	2
Enclosure class (IEC 34-5):	55 Dust/Jetting
Insulation class (IEC 85):	F
Built-in motor protection:	NONE
Motor No:	85U01908
Controls:	
Frequency converter:	NONE
Others:	
Minimum efficiency index, MEI ≥:	0.57
Net weight:	39.9 kg
Gross weight:	42.8 kg
Shipping volume:	0.13 m ³
Sales region:	Great Britain

96531671 CRN 5-13 A-FGJ-H-E-HQQE 50 Hz

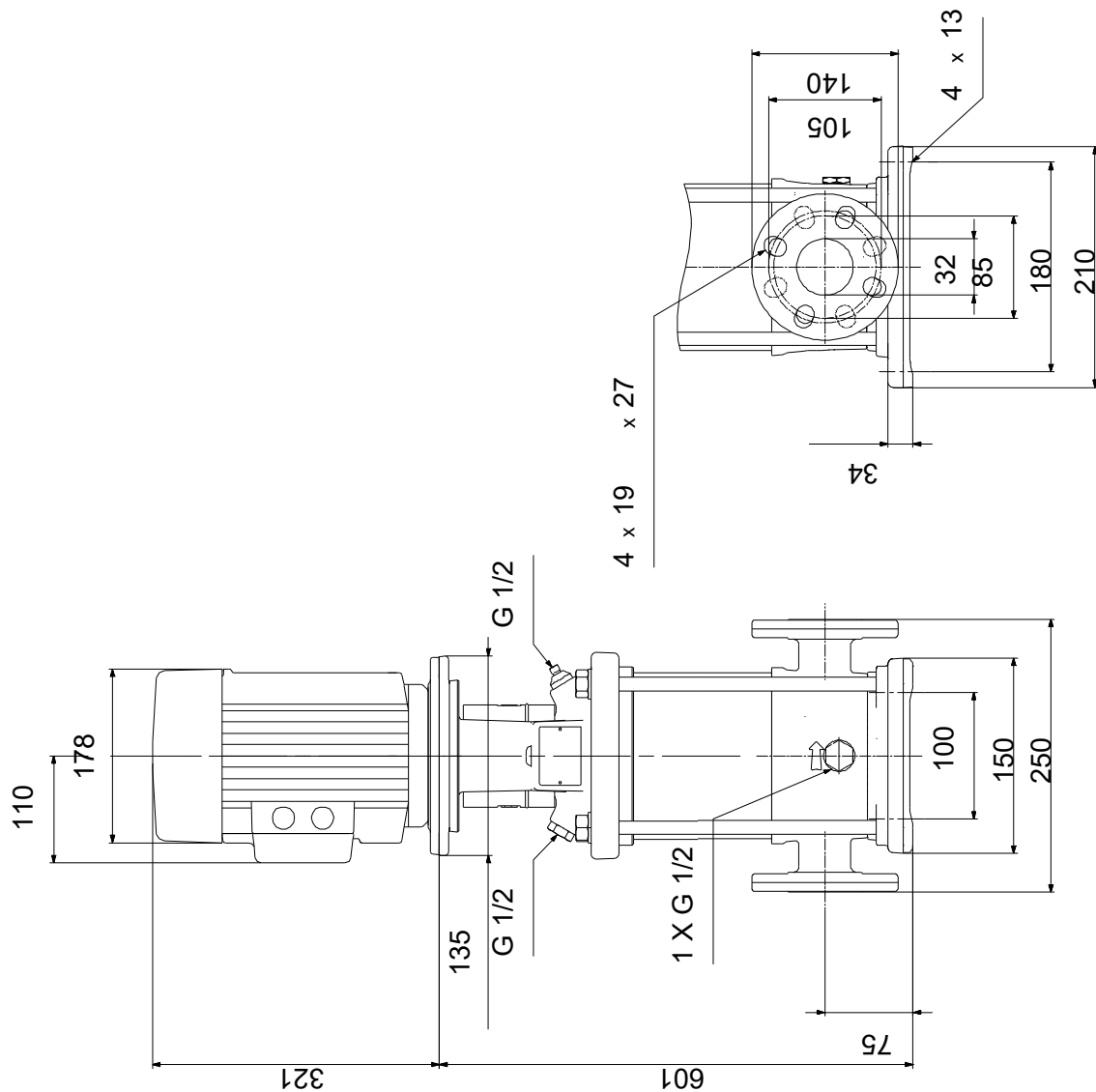

Note! All units are in [mm] unless others are stated.
 Disclaimer: This simplified dimensional drawing does not show all details.

