

Qty.	Description
1	<p data-bbox="201 159 485 185">CRE 32-6 N-F-A-E-HQQE</p> <div data-bbox="331 197 453 533" style="text-align: center;">  </div> <p data-bbox="592 506 1062 528" style="text-align: center;">Note! Product picture may differ from actual product</p> <p data-bbox="201 539 464 562">Product No.: 96122672</p> <p data-bbox="201 600 1430 696">Vertical, multistage centrifugal pump with inlet and outlet ports on same the level (inline). The pump head and base are in cast iron – all other wetted parts are in stainless steel. A cartridge shaft seal ensures high reliability, safe handling, and easy access and service. Power transmission is via a rigid split coupling. Pipe connection is via DIN flanges.</p> <p data-bbox="201 741 916 763">The pump is fitted with a 3-phase, fan-cooled asynchronous motor.</p> <p data-bbox="201 772 1394 819">The motor includes a frequency converter and PI controller in the motor terminal box. This enables continuously variable control of the motor speed, which again enables adaptation of the performance to a given requirement.</p> <p data-bbox="201 828 1449 875">An operating panel on the motor terminal box enables setting of required setpoint as well as setting of pump to "Min." or "Max." operation or to "Stop". The operating panel has indicator lights for "Operation" and "Fault".</p> <p data-bbox="201 884 1422 958">Communication with the pump is possible by means of Grundfos GO Remote (accessory). The remote control enables further settings as well as reading out of a number of parameters such as "Actual value", "Speed", "Power input" and total "Power consumption".</p> <p data-bbox="201 972 794 994">The terminal box holds terminals for these connections:</p> <ul data-bbox="240 1003 1458 1352" style="list-style-type: none"> • pump start/stop input (potential-free contact) • remote setpoint setting via analog signal, 0-10 V, 0(4)-20 mA • 10 V voltage supply for setpoint potentiometer, I_{max} = 5 mA • three analog sensor inputs, 0-10 V, 0(4)-20 mA; the factory-fitted pressure sensor is connected to one of these inputs • 24 V voltage supply for sensor, I_{max} = 40 mA • one analog output • three digital inputs • two Pt100 inputs • two potential-free fault signal relays with changeover contact, reporting "Fault", "Operation" or "Ready" • RS-485 GENIbus connection • interface for Grundfos CIM fieldbus module. <p data-bbox="201 1386 512 1413">Further product details</p> <p data-bbox="201 1422 1366 1469">The pump is equipped with a pressure sensor registering pump outlet pressure and enabling controlled pump operation based on constant pressure.</p> <p data-bbox="201 1478 1449 1525">An operating panel on the motor terminal box enables setting of required setpoint as well as setting of pump to "Min." or "Max." operation or to "Stop". The operating panel has indicator lights for "Operation" and "Fault".</p> <p data-bbox="201 1534 1422 1608">Communication with the pump is possible by means of Grundfos GO Remote (accessory). The remote control enables further settings as well as reading out of a number of parameters such as "Actual value", "Speed", "Power input" and total "Power consumption".</p> <p data-bbox="201 1621 1394 1668">Steel, cast iron and aluminium components have an epoxy-based coating made in a cathodic electro-deposition (CED) process.</p> <p data-bbox="201 1677 1430 1724">CED is a high-quality dip-painting process where an electrical field around the products ensures deposition of paint particles as a thin, well-controlled layer on the surface.</p> <p data-bbox="201 1738 719 1760">An integral part of the process is a pretreatment.</p> <p data-bbox="201 1769 700 1792">The entire process consists of these elements:</p> <ol data-bbox="225 1800 703 1912" style="list-style-type: none"> 1) Alkaline-based cleaning. 2) Zinc phosphating. 3) Cathodic electro-deposition. 4) Curing to a dry film thickness 18-22 my m. <p data-bbox="201 1921 892 1944">The colour code for the finished product is NCS 9000/RAL 9005.</p> <p data-bbox="201 1977 280 2004">Pump</p> <p data-bbox="201 2013 1430 2060">A long split coupling connects the pump and motor shaft. It is enclosed in the motor stool by means of two coupling guards. The long coupling makes it possible to replace the shaft seal without removing the motor from the pump.</p>

Qty.	Description
------	-------------

1

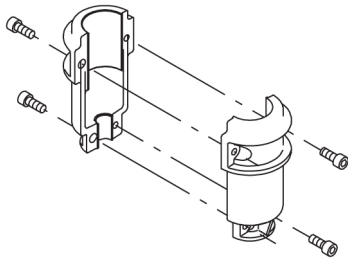

The motor stool connects the pump head and motor. The pump head has a combined 1/2" priming plug and vent screw.

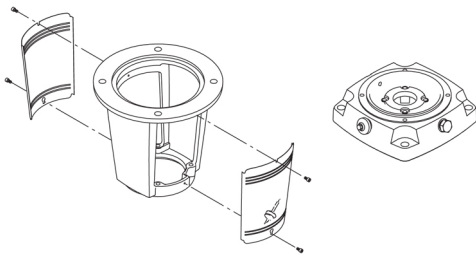

The pump is fitted with a balanced O-ring seal unit with a rigid torque-transmission system.

This seal type is assembled in a cartridge unit which makes replacement safe and easy.

Due to the balancing, this seal type is suitable for high-pressure applications.

The cartridge construction also protects the pump shaft from possible wear from a dynamic O-ring between pump shaft and shaft seal.

Seal faces:

- Rotating seal ring material: silicon carbide (SiC)
- Stationary seat material: silicon carbide (SiC)

This material pairing is used where higher corrosion resistance is required. The high hardness of this material pairing offers good resistance against abrasive particles.

Secondary seal material: EPDM (ethylene-propylene rubber)

EPDM has excellent resistance to hot water. EPDM is not suitable for mineral oils.

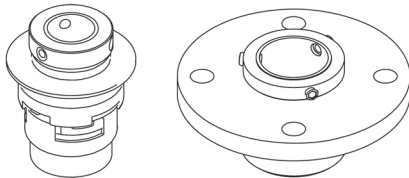

The shaft seal is retained in the pump head by a cover and screws. It can be replaced without removing the motor.

The chambers and impellers are made of stainless-steel sheet. The chambers are provided with a PTFE neck ring offering improved sealing and high efficiency. The impellers have smooth surfaces, and the shape of the blades ensure a high efficiency.

The base is made of cast iron. Both the inlet and the outlet side of the base have two pressure gauge tappings. The pump is secured to the foundation by four bolts through the base plate. The flanges are fastened to the base by means of locking rings.

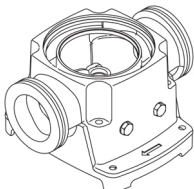

Motor

The motor is a totally enclosed, fan-cooled motor with principal dimensions to IEC and DIN standards. The motor is flange-mounted with free-hole flange (FF).

Motor-mounting designation in accordance with IEC 60034-7: IM B 5 (Code I) / IM 3001 (Code II).

Electrical tolerances comply with IEC 60034.

The motor efficiency is classified as IE3 in accordance with IEC 60034-30-1.

Qty.	Description
1	<p>The motor requires no external motor protection. The motor control unit incorporates protection against slow- and quick-rising temperatures, e.g. constant overload and stalled conditions.</p> <p>Technical data</p> <p>Liquid: Pumped liquid: Water Liquid temperature range: -30 .. 120 °C Selected liquid temperature: 20 °C Density: 998.2 kg/m³</p> <p>Technical: Pump speed on which pump data are based: 3540 rpm Rated flow: 36 m³/h Rated head: 130.9 m Pump orientation: Vertical Shaft seal arrangement: Single Code for shaft seal: HQQE Approvals and markings: CE,EAC,UKCA,SEPRO Approvals for drinking water: WRAS,ACS Curve tolerance: ISO9906:2012 3B</p> <p>Materials: Base: Cast iron EN 1563 EN-GJS-500-7 ASTM A536 80-55-06 Impeller: Stainless steel EN 1.4301 AISI 304 Bearing arrangement: SIC Support bearing: Graflon</p> <p>Installation: t max amb: 40 °C Maximum operating pressure: 30 bar Max pressure at stated temp: 30 bar / 120 °C 30 bar / -30 °C</p> <p>Type of connection: DIN Size of inlet connection: DN 65 Size of outlet connection: DN 65 Pressure rating for connection: PN 40 Flange size for motor: FF300</p> <p>Electrical data: Motor standard: IEC Motor type: 160LB IE Efficiency class: IE3 Rated power - P2: 18.5 kW Power (P2) required by pump: 18.5 kW Over/undersize motor: Standard motor size Mains frequency: 50 / 60 Hz Rated voltage: 3 x 380-480 V Rated current: 37.0-31.0 A Cos phi - power factor: 0.91-0.88 Rated speed: 480-3540 rpm Efficiency: IE3 92,4% Motor efficiency at full load: 92.4 % Number of poles: 2 Enclosure class (IEC 34-5): IP55 Insulation class (IEC 85): F Motor No: 85901026</p> <p>Controls: Frequency converter: Built-in Pressure sensor: Y</p>

Qty.	Description
1	<p>Others:</p> <p>Minimum efficiency index, MEI ≥: 0.70</p> <p>Net weight: 218 kg</p> <p>Gross weight: 269 kg</p> <p>Shipping volume: 0.819 m³</p> <p>Danish VVS No.: 385946560</p> <p>Country of origin: GB</p> <p>Custom tariff no.: 84137075</p>

96122672 CRE 32-6 N-F-A-E-HQQE

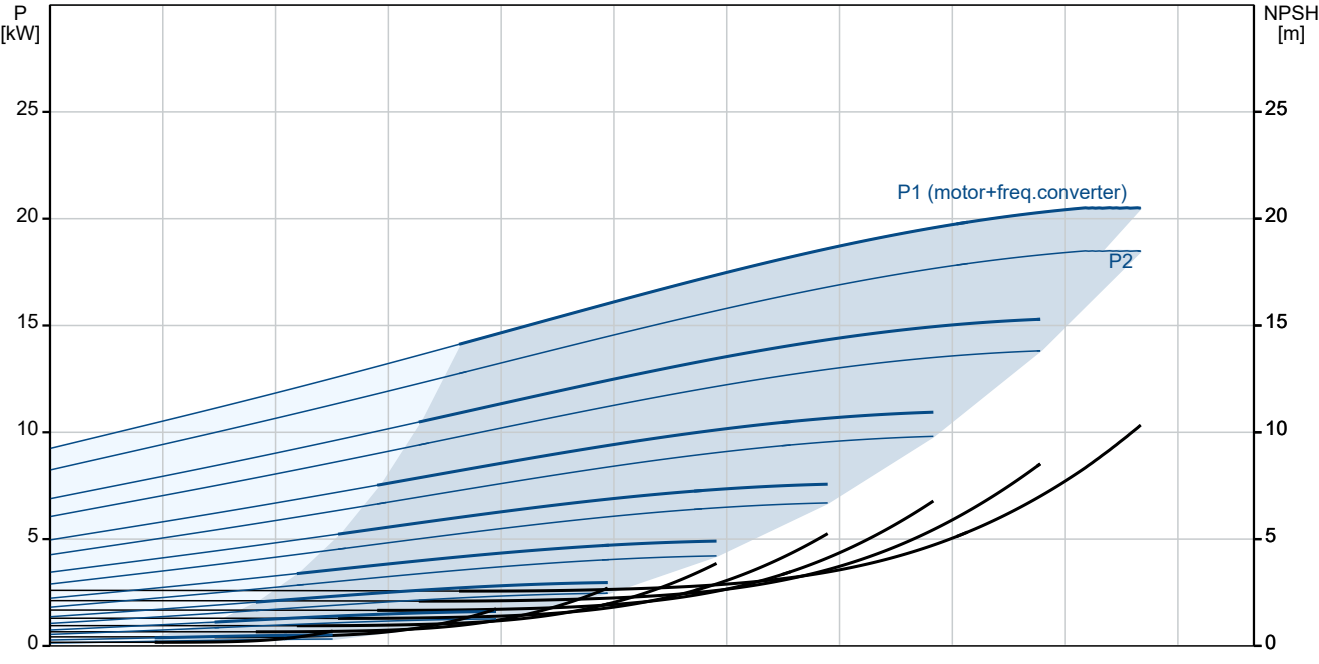
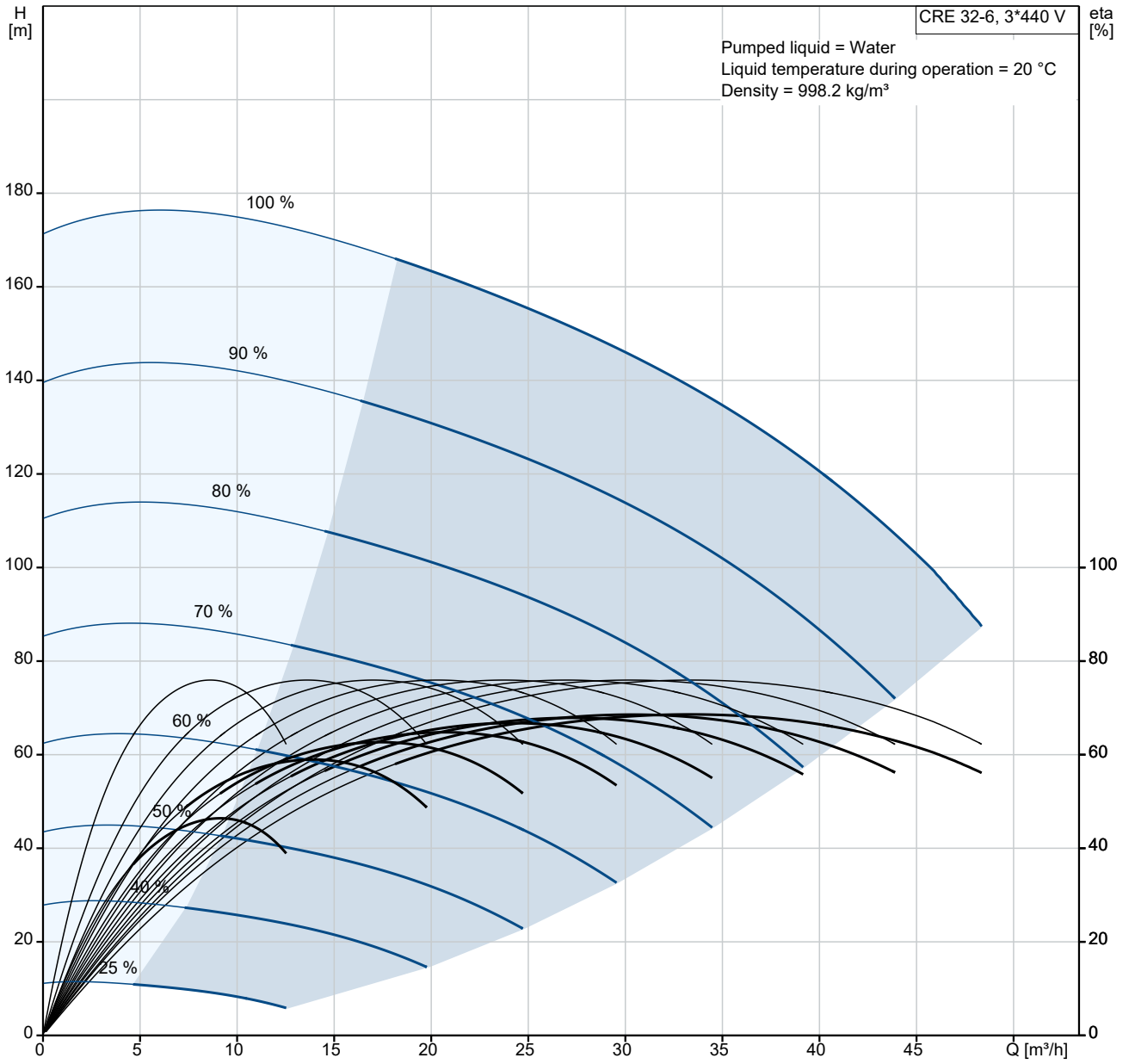

Description	Value
General information:	
Product name:	CRE 32-6 N-F-A-E-HQQE
Product No:	96122672
EAN number:	5700396687162
Technical:	
Pump speed on which pump data are based:	3540 rpm
Rated flow:	36 m ³ /h
Rated head:	130.9 m
Maximum head:	168.7 m
Number of stages:	6
Impellers:	6
Number of reduced-diameter impellers:	0
Low NPSH:	N
Pump orientation:	Vertical
Shaft seal arrangement:	Single
Code for shaft seal:	HQQE
Approvals and markings:	CE,EAC,UKCA,SEPRO
Approvals for drinking water:	WRAS,ACS
Curve tolerance:	ISO9906:2012 3B
Pump version:	N
The first model is called A which is followed by model B, C etc.:	B
Materials:	
Base:	Cast iron
Base:	EN 1563 EN-GJS-500-7
Base:	ASTM A536 80-55-06
Impeller:	Stainless steel
Impeller:	EN 1.4301
Impeller:	AISI 304
Material code:	A
Code for rubber:	E
Bearing arrangement:	SIC
Support bearing:	Graflon
Installation:	
t max amb:	40 °C
Maximum operating pressure:	30 bar
Max pressure at stated temp:	30 bar / 120 °C
Max pressure at stated temp:	30 bar / -30 °C
Type of connection:	DIN
Size of inlet connection:	DN 65
Size of outlet connection:	DN 65
Pressure rating for connection:	PN 40
Flange size for motor:	FF300
Connect code:	F
Liquid:	
Pumped liquid:	Water
Liquid temperature range:	-30 .. 120 °C
Selected liquid temperature:	20 °C
Density:	998.2 kg/m ³
Electrical data:	
Motor standard:	IEC
Motor type:	160LB
IE Efficiency class:	IE3
Rated power - P2:	18.5 kW
Power (P2) required by pump:	18.5 kW
Over/undersize motor:	Standard motor size
Mains frequency:	50 / 60 Hz
Rated voltage:	3 x 380-480 V
Rated current:	37.0-31.0 A
Cos phi - power factor:	0.91-0.88
Rated speed:	480-3540 rpm

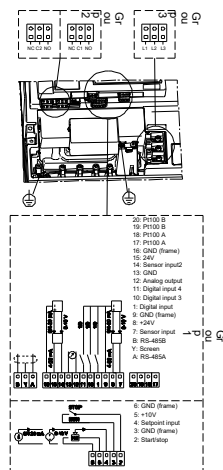
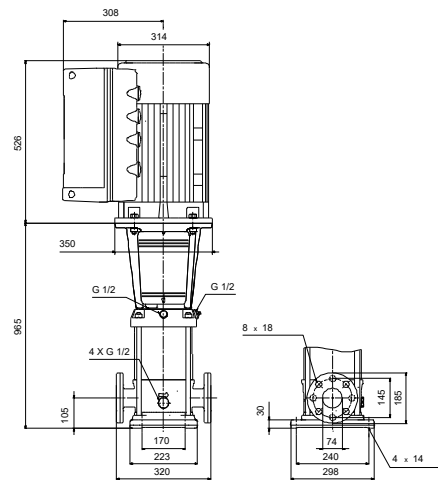
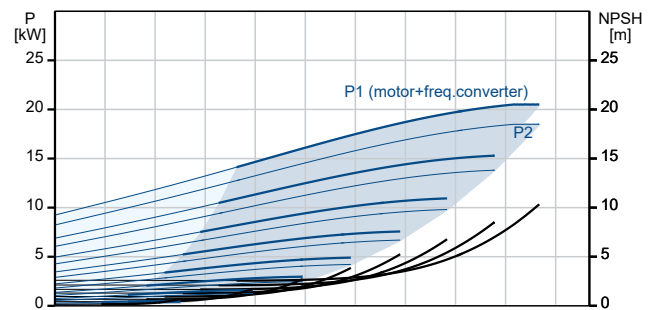
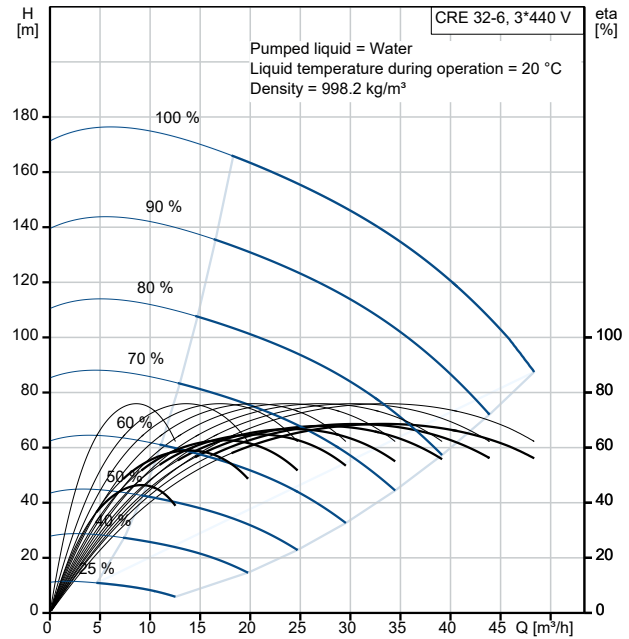

Description	Value
Efficiency:	IE3 92,4%
Motor efficiency at full load:	92.4 %
Number of poles:	2
Enclosure class (IEC 34-5):	IP55
Insulation class (IEC 85):	F
Built-in motor protection:	YES
Motor No:	85901026
Controls:	
Function Module:	ADVANCED I/O
Frequency converter:	Built-in
Pressure sensor:	Y
Others:	
Minimum efficiency index, MEI ≥:	0.70
Net weight:	218 kg
Gross weight:	269 kg
Shipping volume:	0.819 m ³
Config. file no:	95139532
Danish VVS No.:	385946560
Country of origin:	GB
Custom tariff no.:	84137075

96122672 CRE 32-6 N-F-A-E-HQQE

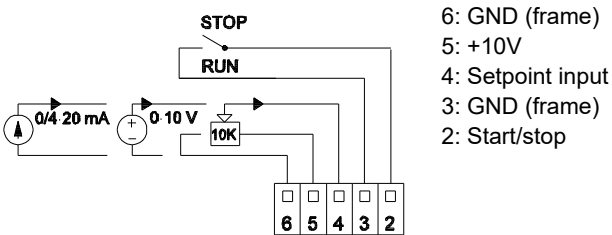
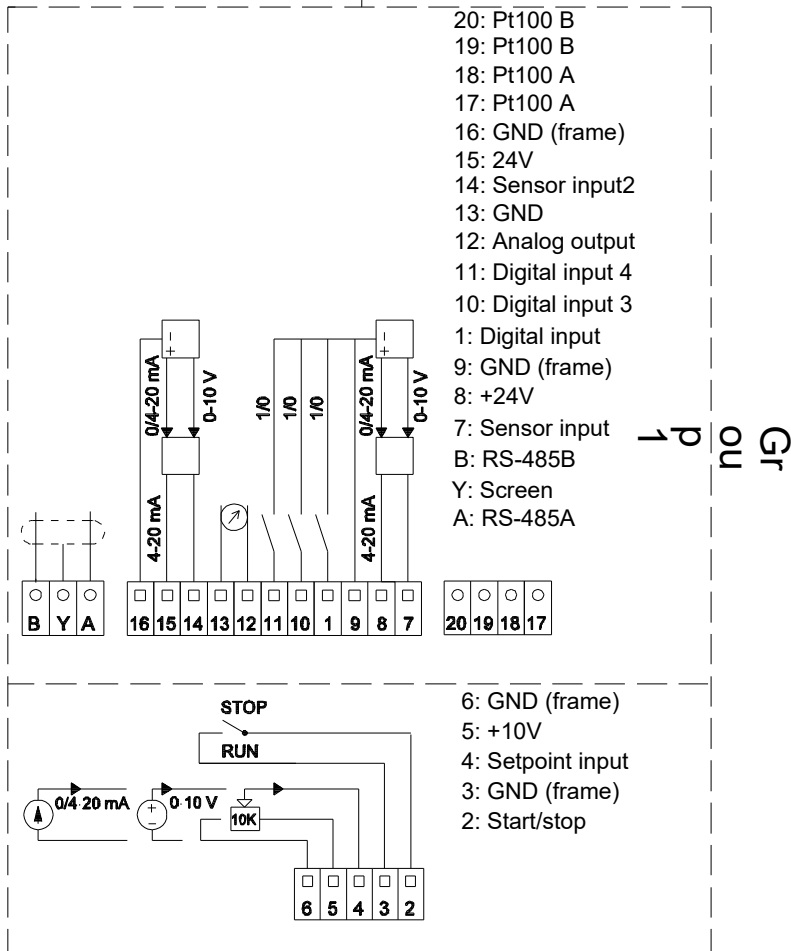
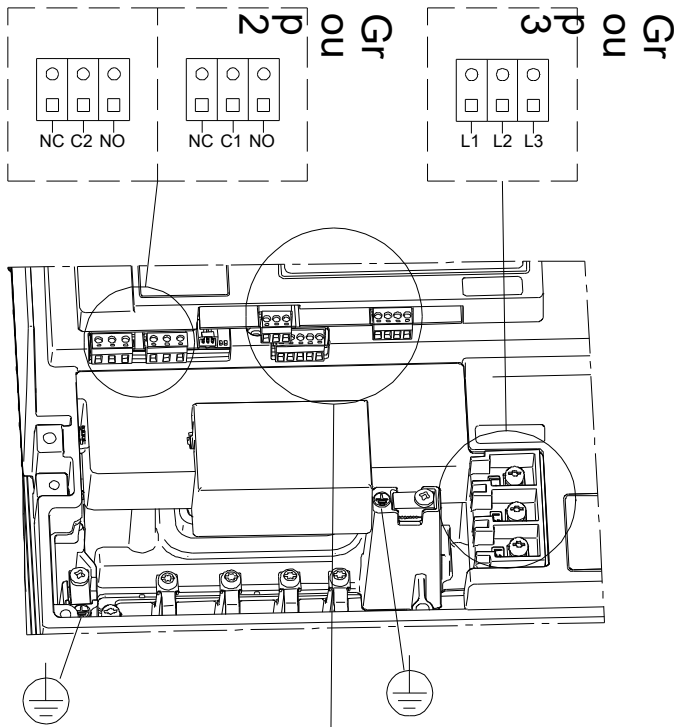

Note! All units are in [mm] unless others are stated.

