

## Data sheet

### Hydraulic data

Maximum operating pressure $P_N$	10 bar
Flow max $Q_{max}$	2,7 m <sup>3</sup> /h
Minimum suction head at 50 °C $m$	0,5 m
Minimum suction head at 95 °C $m$	3 m
Minimum suction head at 110 °C	10 m
Min. fluid temperature $T_{min}$	-10 °C
Max. fluid temperature $T_{max}$	95 °C
Max. fluid temperature for max. ambient temperature of +25 °C $T_{max}$	95 °C
Max. fluid temperature for max. ambient temperature of +40 °C $T_{max}$	95 °C
Min. ambient temperature $T_{min}$	-10 °C
Max. ambient temperature $T_{max}$	40 °C

### Motor data

Energy efficiency index (EEI)	0,18
Mains connection	1~230 V ±10%, 50/60 Hz
Min. speed $n_{min}$	700 1/min
Max. speed $n_{max}$	3400 1/min
Power consumption $P_{1min}$	3 W
Power consumption $P_{1max}$	20 W
Interference emission	EN 61000-6-3
Interference immunity	EN 61000-6-2
Electromagnetic compatibility	EN 61800-3
Threaded cable connection	1 x PG11
Insulation class	F
Protection class	IPX2D

### Materials

Pump housing	Cast iron
Impeller	PP-GF40
Shaft	Stainless steel
Bearing	Carbon, metal-impregnated

### Installation dimensions

Pipe connection on the pressure side $DN_d$	G 1½
Pipe connection on the suction side $DN_s$	G 1½
Port-to-port length $L_0$	130 mm

Pump curves

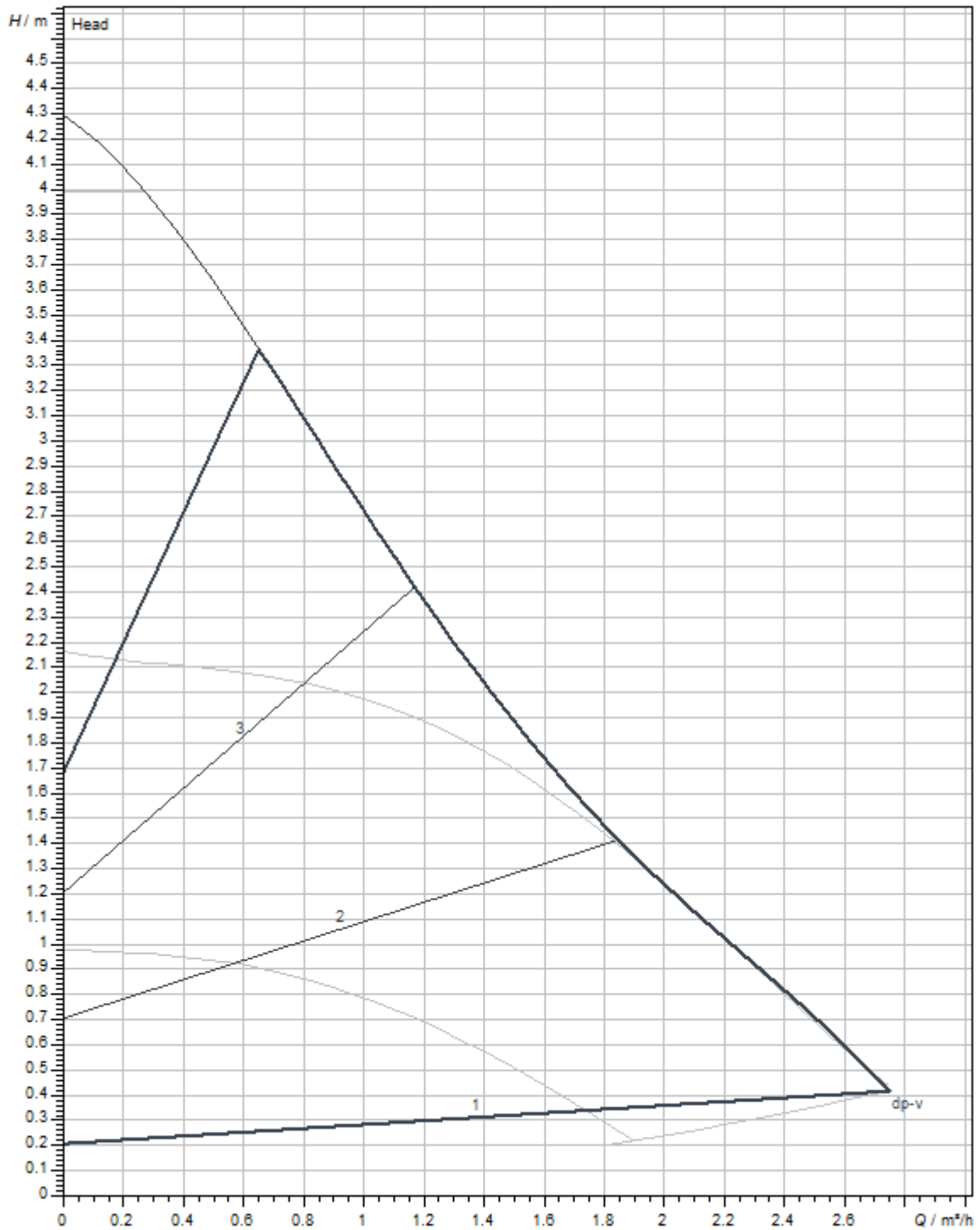

Dimensions and dimensions drawings

4215514\_ConGraph\_yonos\_pico\_row\_130\_dim\_01\_1708

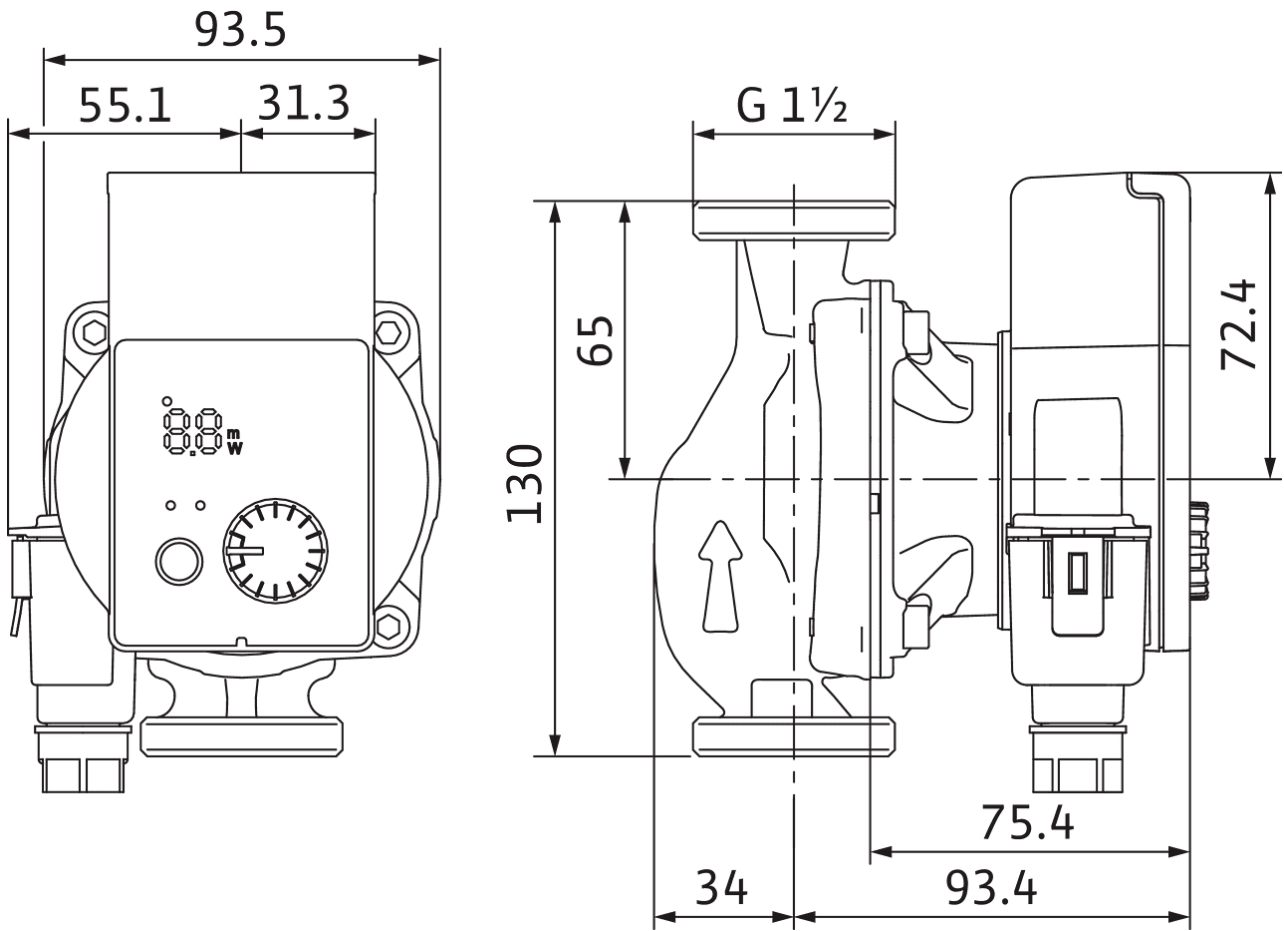

Wiring diagram

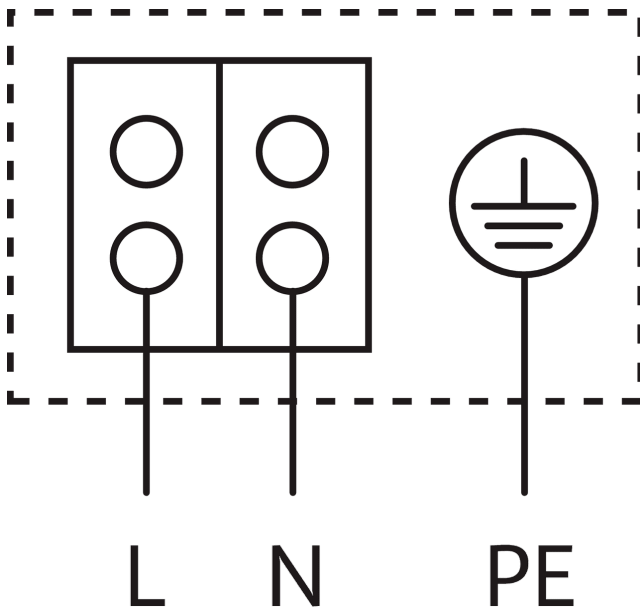

Blocking current-proof motor

**Single-phase motor** (EM) 2-pole - 1~230 V, 50 Hz