

**Qty. Description**

1 SP 125-5-AA



**Note! Product picture may differ from actual product**

Product No.: [17A043B5](#)

Submersible borehole pump, suitable for pumping clean water. Can be installed vertically or horizontally. All steel components are made in stainless steel, EN 1.4301 (AISI 304), that ensures high corrosive resistance. This pump carries drinking water approval.

The pump is fitted with a 45 kW MMS8000 motor with sand shield, water-lubricated journal bearings and a volume compensating diaphragm.

The rewindable motor construction allows complete access to the windings for easy rewinding.

The stator windings are PE/PA insulated made for continuous operations (S1).

Suitable for temperatures up to 50 °C.

The motor is fitted with a mechanical shaft seal.

The motor is not fitted with a temperature sensor. If temperature monitoring is desired, a Pt100 or Pt1000 sensor can be fitted.

The motor is for direct-on-line starting (DOL).

**Further product details**

The pump is suitable for applications similar to the following:

- raw-water supply
- irrigation
- groundwater lowering
- pressure boosting
- fountain applications.

**Pump**

All pump surfaces that are in contact with pumped liquids are made in stainless steel which makes them corrosion- and wear-resistant. The corrosion diagram below shows the capabilities of the pump and motor in relation to the temperature in Celsius (y-axis) and the concentration of chloride in ppm (x-axis).

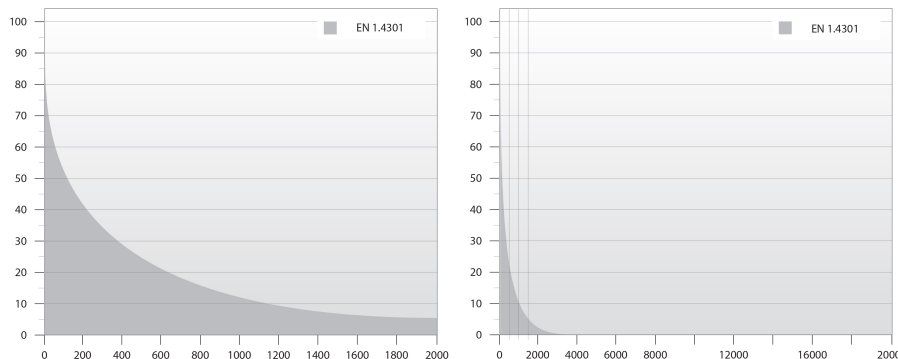

The elastomer parts in the pump are made of NBR (Nitrile-Butadiene Rubber) which ensures good wear resistance and long service intervals.

In case the pump is used for pumping water with high content of hydrocarbons or solvents, Grundfos offers FKM rubber parts (Fluorocarbon) which are oil and temperature-resistant up to 90 °C.

The pump is built with octagonal bearings with sand flush channels that minimise wear. As wear of the pump is inevitable, the pump design allows for easy replacement of all internal wear parts (bearings, impeller, wear rings and seal rings) to maintain high performance and a long lifetime.

Qty.	Description
1	<p>The suction interconnector is fitted with a strainer to prevent large particles from entering the pump. The suction interconnector is designed to comply with NEMA standards for motor mounting/dimensions.</p> <p><b>Motor</b></p> <p>The winding wire is made from pure electrolytic copper insulated by extruded two layers of PE/PA with high dielectric strength properties allowing direct contact between the motor fluid and winding wire.</p> <p>This ensures the best possible cooling of the winding wire.</p> <p>The PA layer ensures high mechanical wear properties of the winding wire.</p> <p>The shaft seal faces are SiC/SiC.</p> <p>The material combination gives good performance when abrasive particles (sand) is present.</p> <p>Together with the shaft seal housing, the sand shield forms a labyrinth seal, which during normal operating conditions prevents penetration of sand particles into the shaft seal.</p> <p>This shaft seal is drinking water approved.</p> <p>The motor can be fitted with a Pt100 or Pt1000 sensor that together with a control unit ensures that the maximum operating temperature conditions are not exceeded.</p> <p>Liquid:</p> <p>Pumped liquid: Water</p> <p>Liquid temperature range: -15 .. 45 °C</p> <p>Max liquid t at 0.15 m/sec: 40 °C</p> <p>Max liquid t at 0.5 m/sec: 45 °C</p> <p>Selected liquid temperature: 20 °C</p> <p>Density: 998.2 kg/m<sup>3</sup></p> <p>Technical:</p> <p>Pump speed on which pump data are based: 2900 rpm</p> <p>Rated flow: 125 m<sup>3</sup>/h</p> <p>Rated head: 87 m</p> <p>Shaft seal for motor: SiC/SiC</p> <p>Curve tolerance: ISO9906:2012 3B</p> <p>Motor version: T45</p> <p>Return valve: YES</p> <p>Materials:</p> <p>Pump: Stainless steel EN 1.4301 AISI 304</p> <p>Impeller: Stainless steel EN 1.4301 AISI 304</p> <p>Motor: Cast iron DIN W.-Nr. 0.6025 ASTM 35-40</p> <p>Installation:</p> <p>Maximum operating pressure: 60 bar</p> <p>Maximum permissible outlet pressure: 12.9 bar</p> <p>Pump outlet: RP6</p> <p>Motor diameter: 8 inch</p> <p>Minimum borehole diameter: 225 mm</p> <p>Electrical data:</p> <p>Motor type: MMS8000</p> <p>Motor flange design: GRUNDFOS</p> <p>Rated power - P2: 45 kW</p> <p>Power (P2) required by pump: 45 kW</p> <p>Mains frequency: 50 Hz</p> <p>Rated voltage: 3 x 380-400-415 V</p> <p>Rated current: 95.5-96.5-96.0 A</p>



Company name:

Created by:

Phone:

Date:

07/11/2022

**Qty. Description**

1	Starting current:	560-600-680 %
	Cos phi - power factor:	0.88-0.82-0.80
	Rated speed:	2900-2910-2920 rpm
	Start. method:	direct-on-line
	Enclosure class (IEC 34-5):	IP68
	Built-in temp. transmitter:	no
	Motor No:	96476891
	Windings:	PE2/PA
	Others:	
	Minimum efficiency index, MEI ≥:	-.--
	ErP status:	EuP Standalone/Prod.
	Net weight:	238 kg
	Gross weight:	282 kg
	Shipping volume:	0.393 m <sup>3</sup>

## 17A043B5 SP 125-5-AA 50 Hz

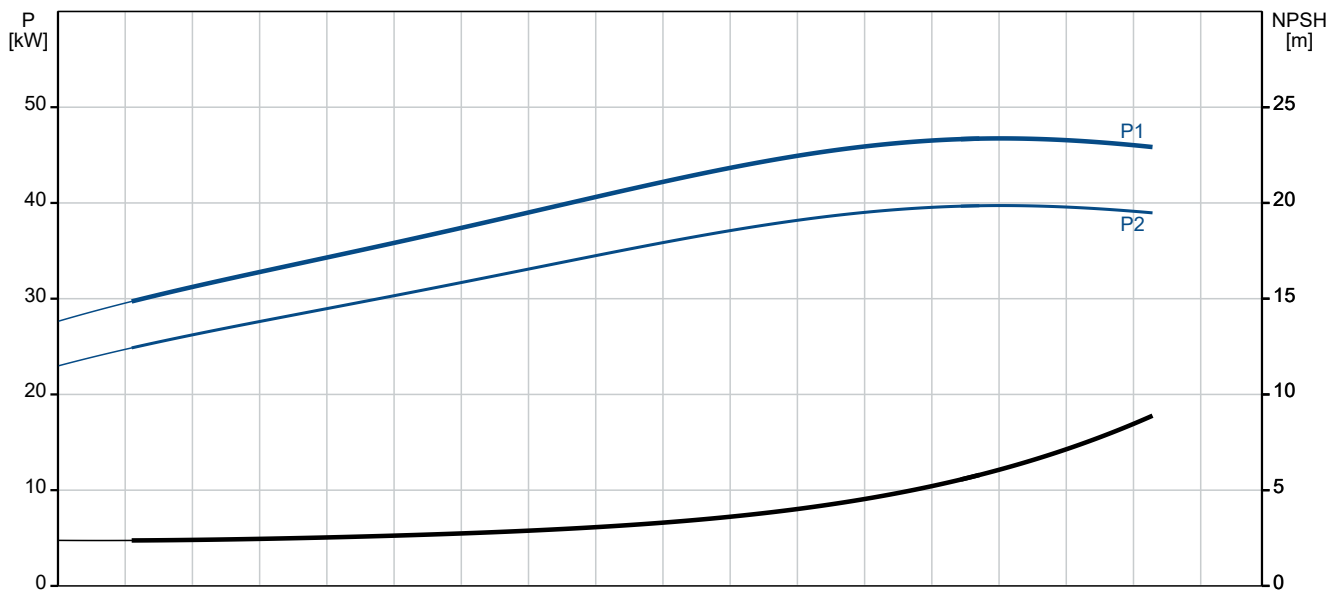
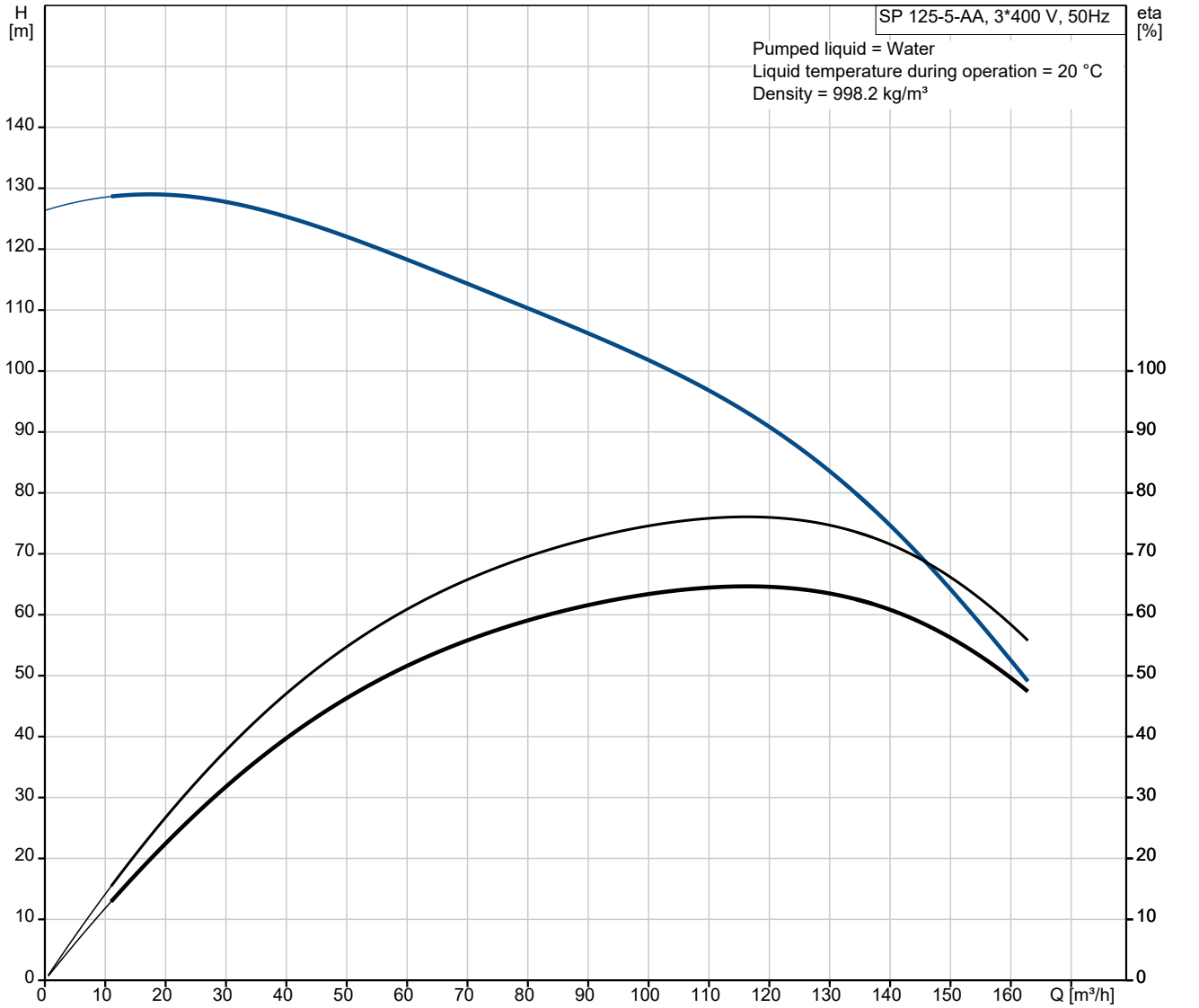

Description	Value
<b>General information:</b>	
Product name:	SP 125-5-AA
Product No:	17A043B5
EAN number:	5700318514248
<b>Technical:</b>	
Pump speed on which pump data are based:	2900 rpm
Rated flow:	125 m <sup>3</sup> /h
Rated head:	87 m
Number of stages:	5
Number of reduced-diameter impellers:	AA
Shaft seal for motor:	SIC/SIC
Curve tolerance:	ISO9906:2012 3B
The first model is called A which is followed by model B, C etc.:	D
Motor version:	T45
Return valve:	YES
<b>Materials:</b>	
Pump:	Stainless steel
Pump:	EN 1.4301
Pump:	AISI 304
Impeller:	Stainless steel
Impeller:	EN 1.4301
Impeller:	AISI 304
Motor:	Cast iron
Motor:	DIN W.-Nr. 0.6025
Motor:	ASTM 35-40
<b>Installation:</b>	
Maximum operating pressure:	60 bar
Maximum permissible outlet pressure:	12.9 bar
Pump outlet:	RP6
Motor diameter:	8 inch
Minimum borehole diameter:	225 mm
<b>Liquid:</b>	
Pumped liquid:	Water
Liquid temperature range:	-15 .. 45 °C
Max liquid t at 0.15 m/sec:	40 °C
Max liquid t at 0.5 m/sec:	45 °C
Selected liquid temperature:	20 °C
Density:	998.2 kg/m <sup>3</sup>
<b>Electrical data:</b>	
Motor type:	MMS8000
Motor flange design:	GRUNDFOS
Rated power - P2:	45 kW
Power (P2) required by pump:	45 kW
Mains frequency:	50 Hz
Rated voltage:	3 x 380-400-415 V
Rated current:	95.5-96.5-96.0 A
Starting current:	560-600-680 %
Cos phi - power factor:	0.88-0.82-0.80
Rated speed:	2900-2910-2920 rpm
Start. method:	direct-on-line
Enclosure class (IEC 34-5):	IP68
Built-in motor protection:	NONE
Thermal protec:	external
Built-in temp. transmitter:	no
Motor No:	96476891
Windings:	PE2/PA
<b>Others:</b>	

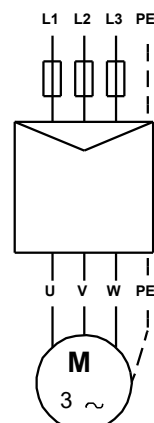
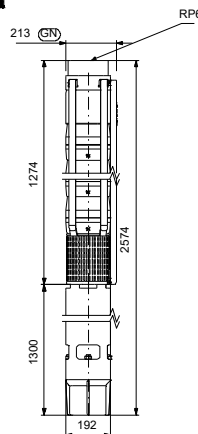
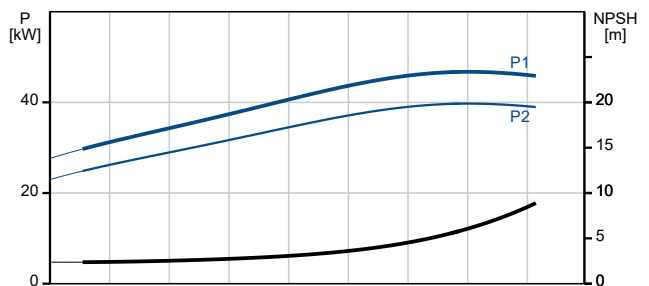
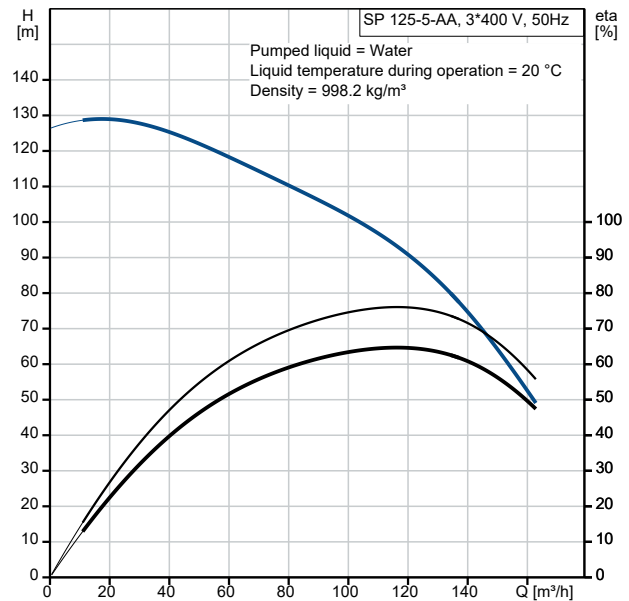



Company name:

Created by:

Phone:

Date: 07/11/2022

Description	Value
Minimum efficiency index, MEI ≥:	--
ErP status:	EuP Standalone/Prod.
Net weight:	238 kg
Gross weight:	282 kg
Shipping volume:	0.393 m <sup>3</sup>

## 17A043B5 SP 125-5-AA 50 Hz

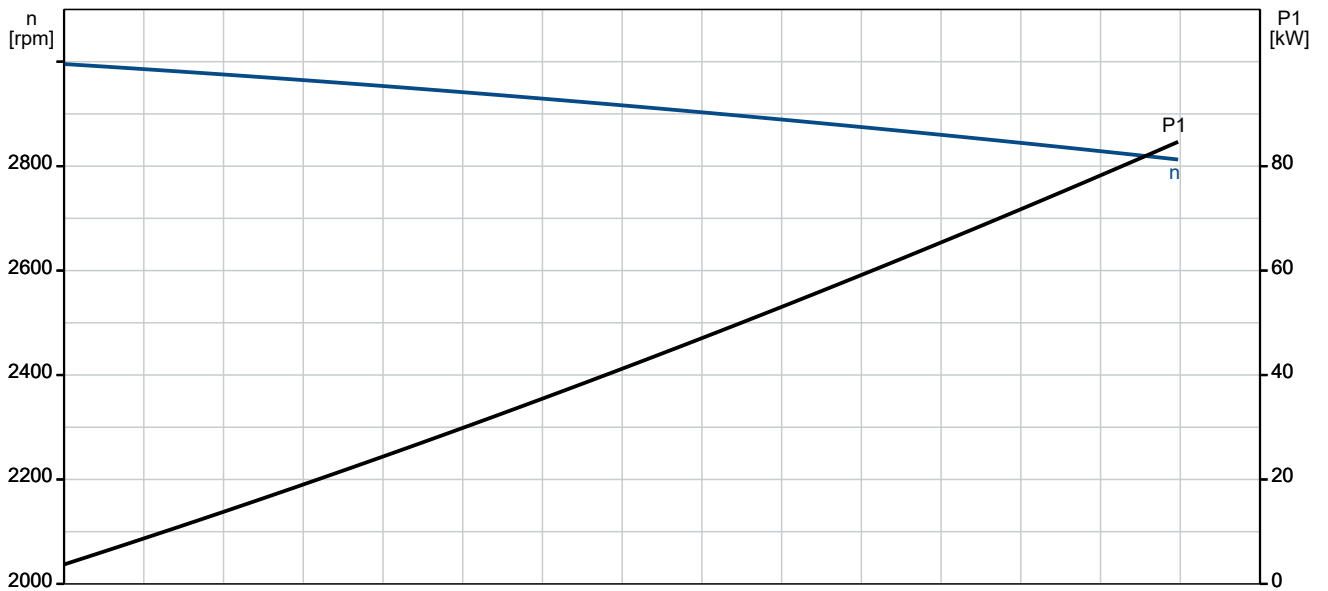
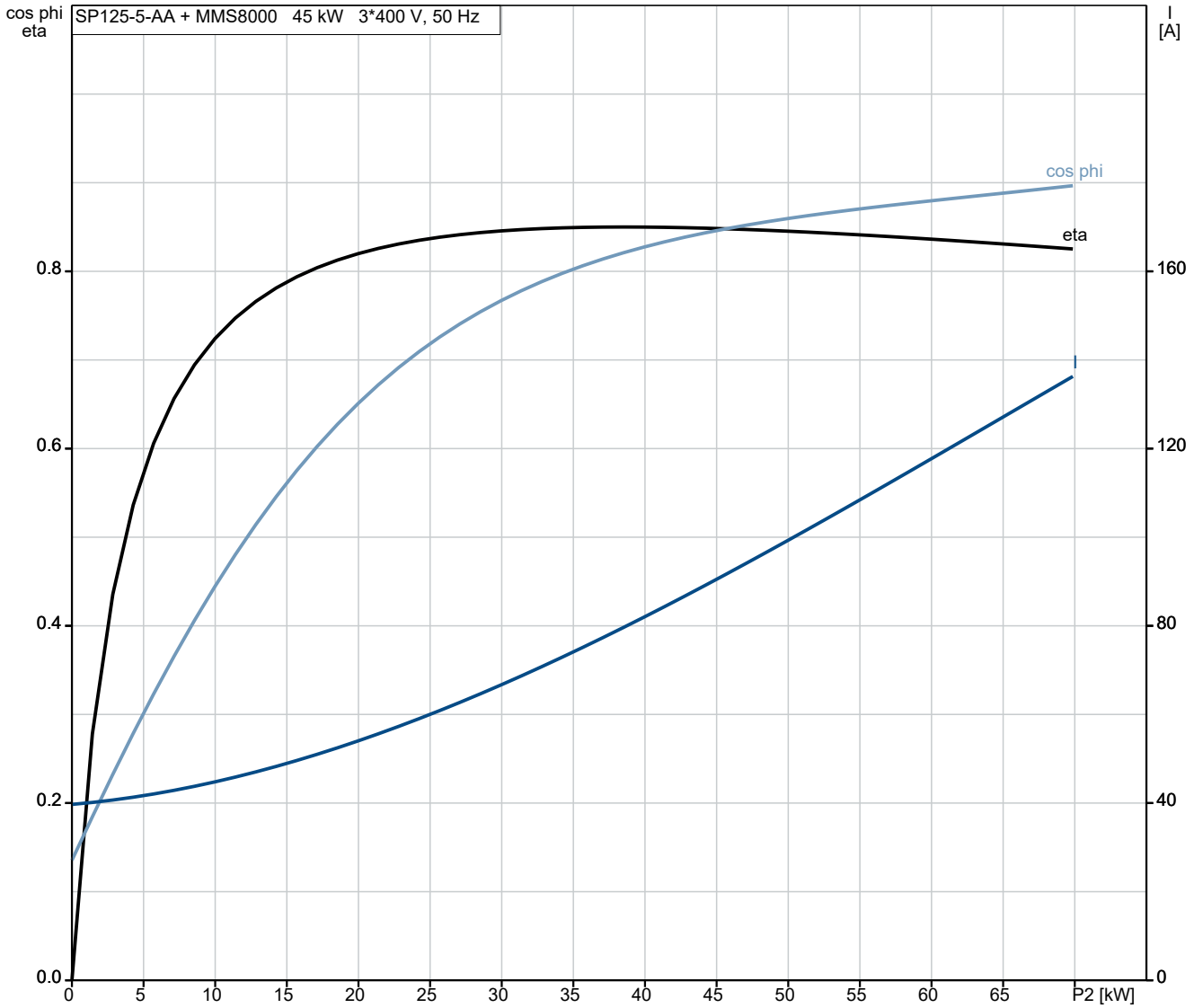

## 17A043B5 SP 125-5-AA 50 Hz

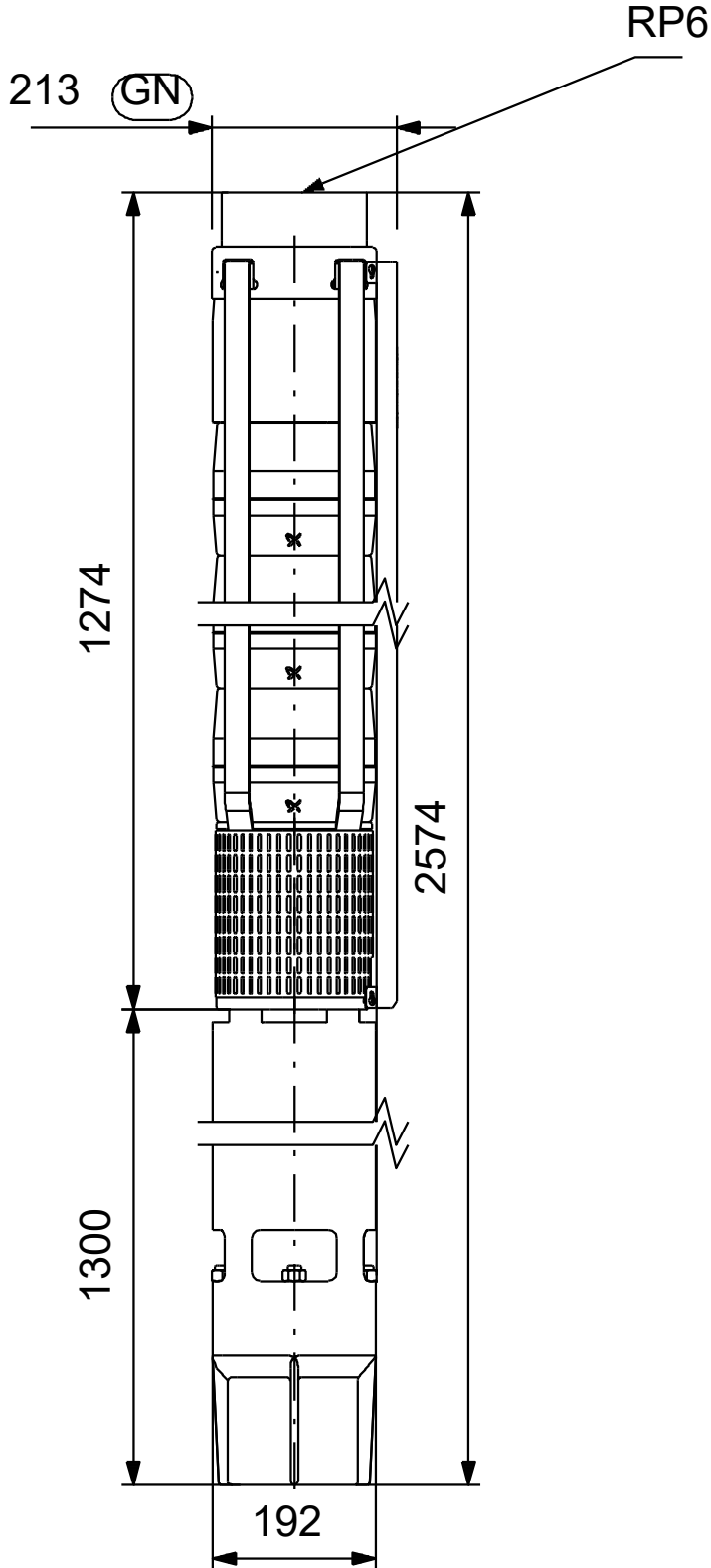

Note! All units are in [mm] unless others are stated.  
Disclaimer: This simplified dimensional drawing does not show all details.



**17A043B5 SP 125-5-AA 50 Hz**

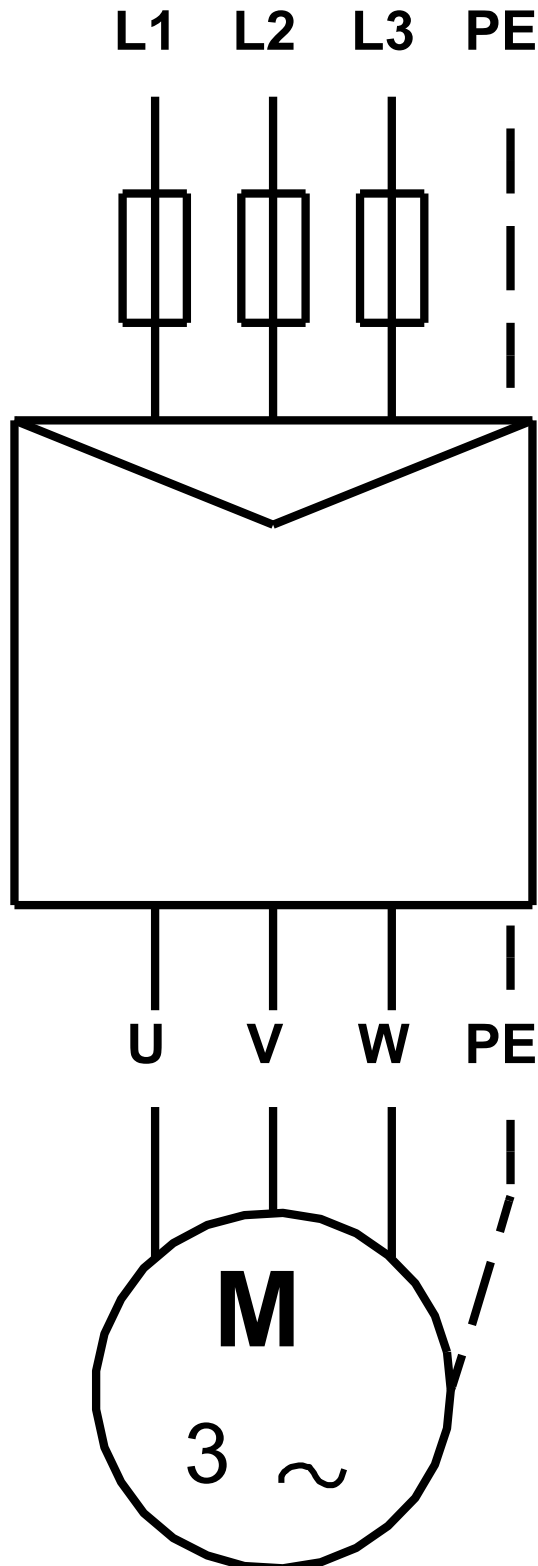

Note! All units are in [mm] unless others are stated.



Company name:

Created by:

Phone:

Date:

07/11/2022

**Order Data:**

<b>Position</b>	<b>Your pos.</b>	<b>Product name</b>	<b>Amount</b>	<b>Product No</b>	<b>Total</b>
		SP 125-5-AA	1	17A043B5	Price on request